



1

## Tool Containers and Assortments



# 01 Tool Containers and Assortments

Takım Arabaları

## GT-MAX Roller Cabinets



The ultimate in tool storage

We believe the ultimate in hand tools deserves the ultimate in tool storage. Therefore after endless hours, weeks and months of research and many user interviews we have developed the new GT-MAX roller cabinet series.

This range addresses even the most diverse user needs in the typical Ceta Form cabinet build quality. As you flip through the catalogue, you will see a lot of variants for different user profiles. The cabinets can also be fitted with a selection of CFS tool modules larger than ever (pages 43 - 57) and a range of accessories (pages 29 - 30).

Experience the new dimension in tool storage by yourself.



### SAFE

Three-staged locking system prevents tilting, unintentional opening of drawers and secures the tools.



### VERSATILE

6, 7 or 8 drawers? Standard body or Jumbo body? Your preferred color configuration? All possible in the GT-MAX range.



### ADAPTABLE

Euro perforated side wall and a large range of accessories allow for a totally custom-built cabinet. CFS tool module system for the final touch.



### TOUGH

Torsion resistant profile construction from heavy gauge steel and plastic protection on all corners against impacts.



For purchase quantities of 5 and more, we can manufacture in your corporate colours (please indicate the RAL code)

# Comparison of Features

**GT**MAX



**GT**PLUS



**GT**



Series	A01M	A01	A02
Drawers	6 / 7 / 8	6 / 7 / 8 / 11	3 / 5 / 6
Inside dimension	525 x 385 / 700 x 385 mm	525 x 385 / 700 x 385 mm	525 x 385 mm
Top Tray	Plastic	PVC Mat	PVC Mat
Colours	Black	Anthracite Gray / Red	Anthracite Gray / Red
Safety concept	3-stage (incl. anti-tilting protection)	2-stage	2-stage
Wheels	dia. 125 mm	dia. 125 mm	dia. 100 mm
Parking Brake	1	1	1
Drawer extension	100%	100%	100%
Drawer load max.	25 / 50 kg	25 / 50 kg	25 kg

**CFS**



All Ceta Form cabinets in above product families can easily be equipped by CFS Ceta Form foam system tool modules. Our tool cabinets equipped with CFS modules offer unmatched traceability and efficiency in MRO and manufacturing environments.

Please refer to page 43-57 for the details of our CFS programme.



# 01 Tool Containers and Assortments

## Mobile Worktop Storage

### A01M Series

#### GT-MAX Roller Cabinets (Empty)



#### Body:

- Torsion resistant profile construction from heavy gauge steel
- Corrosion resistant and scratch-proof mat powder coated
- Built-in side panel with Euro perforation for mounting optional accessories
- Plastic protection on all corners against impacts
- High quality ABS worktop, housings for screwdrivers and small parts

#### Drawers:

- Central locking with cylinder lock
- Individual drawer lock system on each drawer to prevent unintentional opening
- Anti-tilting system which prevents opening of more than 1 drawer at a time
- Low friction telescopic ball-bearing slides allowing 100% opening of drawers
- Load capacity per drawer: 25 kg (50 kg for h 210 mm drawers)

#### Wheel System:

- Two fixed and 2 swiveling (one with brake) wheels, Ø125 mm
- High quality TPU material resistant to chemicals

#### Accessories:

- Can be equipped with Ceta Form CFS Tool Modules (page 43 - 57)
- Compatible with an extensive range of accessories (page 29 - 30)
- Delivery with 2 pieces of A01M-CH spray can holder

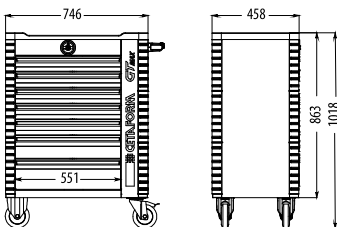
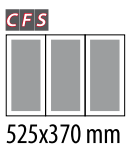

CODE NO	A01M-06	A01M-07	A01M-08
	<b>6 Drawers:</b> 4x type 1, H: 70 mm 1x type 3, H: 110 mm 1x type 5, H: 210 mm	<b>7 Drawers:</b> 5x type 1, H: 70 mm 1x type 3, H: 110 mm 1x type 4, H: 135 mm	<b>8 Drawers:</b> 7x type 1, H: 70 mm 1x type 2, H: 90 mm
HxWxD / mm	1018x746x458	1018x746x458	1018x746x458
kg	67	67	70

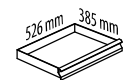

# Mobile Worktop Storage

## A01M-J Series

### GT-MAX Jumbo Roller Cabinets (Empty)



**Body:**

- Torsion resistant profile construction from heavy gauge steel
- Corrosion resistant and scratch-proof mat powder coated
- Built-in side panel with Euro perforation for mounting optional accessories
- Plastic protection on all corners against impacts
- High quality ABS worktop, housings for screwdrivers and small parts

**Drawers:**

- Central locking with cylinder lock
- Individual drawer lock system on each drawer to prevent unintentional opening
- Anti-tilting system which prevents opening of more than 1 drawer at a time
- Low friction telescopic ball-bearing slides allowing 100% opening of drawers
- Load capacity per drawer: 25 kg

**Wheel System:**

- Two fixed and 2 swiveling (one with brake) wheels, Ø125 mm
- High quality TPU material resistant to chemicals

**Accessories:**

- Can be equipped with Ceta Form CFS Tool Modules (page 43 - 57)
- Compatible with an extensive range of accessories (page 29 - 30)
- Delivery with 2 pieces of A01M-CH spray can holder



700x370 mm



RAL 9005

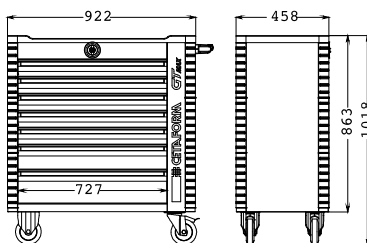

CODE NO	A01M-07J	A01M-08J
	<b>7 Drawers:</b> 5x type 1, H: 70 mm 1x type 2, H: 110 mm 1x type 4, H: 135 mm	<b>8 Drawers:</b> 7x type 1, H: 70 mm 1x type 3, H: 90 mm
HxWxD / mm	1018x922x458	1018x922x458
	77	80

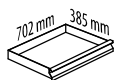

# 01 Tool Containers and Assortments

## Mobile Worktop Storage

### A01 Series

#### GT-PLUS Roller Cabinets (Empty)



#### Body:

- Torsion resistant profile construction from heavy gauge steel
- Corrosion resistant and scratch-proof mat powder coated
- Built-in side panel with spray can holder
- Recessed worktop ensuring a convenient working area

#### Drawers:

- Central locking with cylinder lock
- Individual drawer lock system on each drawer to prevent unintentional opening
- Low friction telescopic ball-bearing slides allowing 100% opening of drawers
- Each drawer can accommodate 3 SBS EVA tool modules
- Load capacity per drawer: 25 kg (50 kg for h 210 mm drawers)



#### Wheel System:

- Two fixed and 2 swiveling (one with brake) wheels, Ø125 mm
- High quality TPU material resistant to chemicals

#### Accessories:

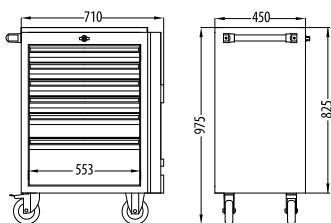
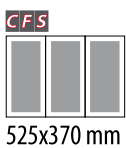
- Can be equipped with Ceta Form CFS Tool Modules (page 43 - 57)
- Compatible with tool chest A06-04 for capacity expansion (page 32)
- Compatible with A01-PS tool panels (page 29)

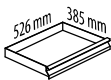

CODE NO	A01-06	A01-07	A01-08
	<b>6 Drawer</b> 4x type1, H: 70 mm 1x type3, H: 110 mm 1x type5, H: 210 mm	<b>7 Drawer</b> 5x type1, H: 70 mm 1x type3, H: 110 mm 1x type4, H: 135 mm	<b>8 Drawer</b> 7x type1, H: 70 mm 1x type2, H: 90 mm
HxWxD / mm	975x710x450	975x710x450	975x710x450
	60	62	72

# Mobile Worktop Storage

## A01-J Series

### GT-PLUS Jumbo Roller Cabinets (Empty)



new



**Body:**

- Torsion resistant profile construction from heavy gauge steel
- Corrosion resistant and scratch-proof mat powder coated
- Built-in side panel with spray can holder
- Recessed worktop ensuring a convenient working area

**Drawers:**

- Central locking with cylinder lock
- Individual drawer lock system on each drawer to prevent unintentional opening
- Low friction telescopic ball-bearing slides allowing 100% opening of drawers
- Each drawer can accommodate 4 SBS EVA tool modules
- Load capacity per drawer: 25 kg

**Wheel System:**

- Two fixed and 2 swiveling (one with brake) wheels, Ø125 mm
- High quality TPU material resistant to chemicals

**Accessories:**

- Can be equipped with Ceta Form CFS Tool Modules (page 43 - 57)
- Compatible with tool chest A06-04JS for capacity expansion (page 32)
- Compatible with A01-PM tool panels (page 29)

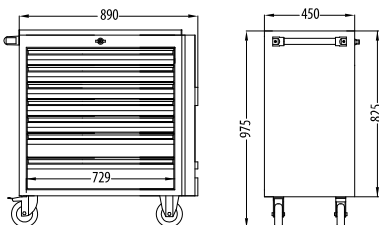
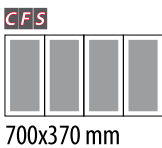

CODE NO	A01-07J	A01-08J
	<b>7 Drawer</b> 5x type1, H: 70 mm 1x type2, H: 110 mm 1x type4, H: 135 mm	<b>8 Drawer</b> 7x type1, H: 70 mm 1x type3, H: 90 mm
HxWxD / mm	975x890x450	975x890x450
	72	74

# 01 Tool Containers and Assortments

## Mobile Worktop Storage

### A01-W Series

#### GT-PLUS XL Roller Cabinets (Empty) - 6 Drawers



A01-06W



RAL 7016

RAL 3020



A01-06WW  
Wood Worktop

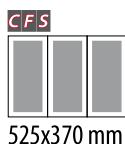

525x370 mm

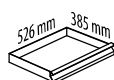
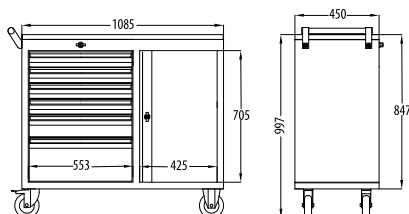

CODE NO	HxWxD / mm		kg
A01-06W	997x1085x450	<b>6 Drawer</b> 4x type1, H: 70 mm 1x type3, H: 110 mm 1x type5, H: 210 mm	74
A01-06WW	997x1085x450	<b>6 Drawer</b> 4x type1, H: 70 mm 1x type3, H: 110 mm 1x type5, H: 210 mm	82

# Mobile Worktop Storage

## A01-11

### GT-PLUS Jumbo XL Roller Cabinet (Empty) - 11 Drawers



“The wide body roller cabinet for maximum capacity requirements”



**Body:**

- Torsion resistant profile construction from heavy gauge steel
- Corrosion resistant and scratch-proof mat powder coated
- Recessed worktop ensuring a convenient working area

**Drawers:**

- Central locking with cylinder lock
- Individual drawer lock system on each drawer to prevent unintentional opening
- Low friction telescopic ball-bearing slides allowing 100% opening of drawers
- Load capacity per drawer: 25 kg (50 kg for h 210 mm drawers)

**Wheel System:**

- Two fixed and 2 swiveling (one with brake) wheels, Ø125 mm
- High quality TPU material resistant to chemicals

**Accessories:**

- Can be equipped with Ceta Form CFS Tool Modules (page 43 - 57)
- Compatible with A01-PL tool panel (page 29)



CFS



525x370 mm





350x370 mm

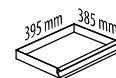
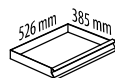
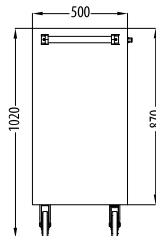
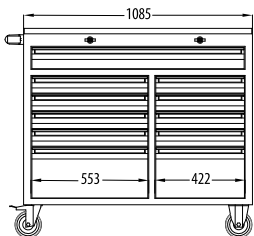

RAL 7016

RAL 3020

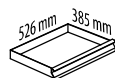
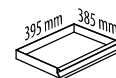

CODE NO	HxWxD / mm			
A01-11	1020x1085x500	<b>5 Drawer</b> 3x type1, H: 70 mm 1x type2, H: 110 mm 1x type3, H: 210 mm Extra 1x wide drawer 982x385 mm, H: 90 mm	<b>5 Drawer</b> 3x type1, H: 70 mm 1x type2, H: 110 mm 1x type3, H: 210 mm	90

# 01 Tool Containers and Assortments

## Mobile Worktop Storage

### A02 Series

#### GT Roller Cabinets (Empty)



#### Body:

- Torsion resistant profile construction from heavy gauge steel
- Corrosion resistant and scratch-proof mat powder coated
- Recessed worktop ensuring a convenient working area
- A02-04 with an integrated locker for bulky parts

#### Drawers:

- Central locking with cylinder lock
- Low friction telescopic ball-bearing slides allowing 100% opening of drawers
- Load capacity per drawer: 25 kg (50 kg for h 210 mm drawers)

#### Wheel System:

- Two fixed and 2 swiveling (one with brake) wheels, Ø100 mm
- High quality TPU material resistant to chemicals

#### Accessories:

- Can be equipped with Ceta Form CFS Tool Modules (page 43 - 57)
- Compatible with tool chest A06-04 for capacity expansion (page 32)

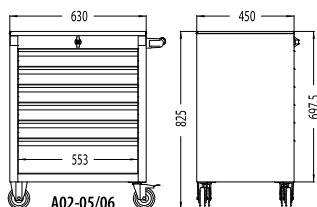
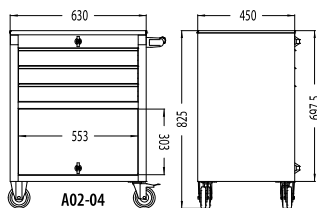
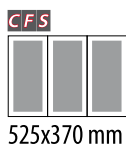

CODE NO	A02-04	A02-05	A02-06
	3 Drawer 3x type1, H: 70 mm	5 Drawer 4x type1, H: 70 mm 1x type3, H: 210 mm	6 Drawer 5x type1, H: 70 mm 1x type2, H: 130 mm
HxWxD / mm	825x630x450	825x630x450	825x630x450
kg	38	47	49

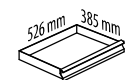

## Mobile Worktop Storage

### A03-SD

#### Basic Tool Cart (Standard Duty)

- Sturdy and dependable construction from heavy gauge steel
- Corrosion resistant and scratch-proof mat powder coated
- Recessed worktop ensuring a convenient working area
- All worktops covered with a PVC mat
- Adjustable central tray location
- Two fixed and 2 swiveling (one with brake) wheels, Ø100 mm
- Maximum static load capacity: 300 kg (distributed between 3 shelves)
- Flat-pack design, easy and low cost to ship; quick and easy to assemble



RAL 7016

CODE NO	HxWxD / mm	kg
A03-SD	930 x 760 x 460	29

### A03-ID

#### Basic Tool Cart (Heavy Duty)

- Sturdy and dependable construction from heavy gauge steel
- Corrosion resistant and scratch-proof mat powder coated
- Recessed worktop ensuring a convenient working area
- All worktops covered with a PVC mat
- Two fixed and 2 swiveling (one with brake) wheels, Ø125 mm
- Maximum static load capacity: 450 kg (distributed between 2 shelves)



RAL 7016

CODE NO	HxWxD / mm	kg
A03-ID	950 x 910 x 560	35

# 01 Tool Containers and Assortments

## Workbenches

### A17L-NW

#### Workbench (Wood Worktop)

- Stable steel framework, rigid structure
- Multiplex wood worktop (oil treated)
- Can be bolted to the floor
- Flat-pack design, easy and low cost to ship; quick and easy to assemble

Production in custom dimensions is possible, please consult your sales representative.



CODE NO	HxWxD / mm	kg
A17L-NW	950 x 1700 x 700	45

### A17L-NS

#### Workbench (Stainless Steel Worktop)



- All structural specs same as A17L-NW
- Stainless steel worktop

CODE NO	HxWxD / mm	kg
A17L-NS	950 x 1700 x 700	59

### A17L-NG

#### Workbench (Galvanized Steel Worktop)



- All structural specs same as A17L-NW
- Galvanized steel worktop

CODE NO	HxWxD / mm	kg
A17L-NG	950 x 1700 x 700	64

# Workbenches

## A17D Series

### Heavy Duty Workbenches - 3 Drawers

- Stable steel framework, rigid structure
- Multiplex wood worktop, oil treated (optionally available in galvanized steel and stainless steel)
- 3 drawers - 100% opening - can be equipped with CFS Tool Modules (page 43-57)
- Can be bolted to the floor

CODE NO	HxWxD / mm	WORKTOP	kg
A17D-W	950 x 1700 x 700	Wooden	69
A17D-S	950 x 1700 x 700	Stainless Steel	84
A17D-G	950 x 1700 x 700	Galvanized	89

## A17D-P Series

### Heavy Duty Workbenches (with Tool Panel) - 3 Drawers

- Stable steel framework, rigid structure
- Multiplex wood worktop, oil treated (optionally available in galvanized steel and stainless steel)
- Integrated heavy duty tool panel A20-170 (page 29)
- 3 drawers - 100% opening - can be equipped with CFS Tool Modules (page 43-57)
- Can be bolted to the floor

**Delivery without hooks, please order separately (page 29)**

CODE NO	HxWxD / mm	WORKTOP	kg
A17D-WP	950 x 1700 x 730	Wooden	88
A17D-SP	950 x 1700 x 730	Stainless Steel	103
A17D-GP	950 x 1700 x 730	Galvanized	108



# 01 Tool Containers and Assortments

## Tool Panels

### A20-200SH

#### Tool Panel With Shutter (Empty) - L

- Euro perforation compatible with A7H series Ceta Form hooks
- Sturdy and dependable steel construction from heavy gauge steel
- Corrosion resistant and scratch-proof mat powder coated
- Aluminium shutter, vertically adjustable, with lock
- Suitable for wall mounting

**Delivery without hooks, please order separately (page 29)**



**new**

CODE NO	WxHxD / mm	kg
A20-200SH	2000 x 900 x 215	51



### A20-110SH

#### Tool Panel With Shutter (Empty) - M

- All structural specs same as A20-200SH
- Smaller dimensions compared to A20-200SH



**new**

CODE NO	WxHxD / mm	kg
A20-110SH	1140 x 900 x 215	30



*Tools on the panel illustrated above are for image purpose only, actual delivery without any tools*

# Tool Panels and Hooks

## A20 Series

### Perforated Tool Panels

- Euro perforation compatible with A17H series Ceta Form hooks
- Sturdy and dependable construction from heavy gauge steel
- Corrosion resistant and scratch-proof mat powder coated
- A20-170 also compatible to A17L series workbenches

**Delivery without hooks, please order separately**

CODE NO	HxW / mm	kg
A20-100	1000 x 700	9
A20-170	1700 x 900	19

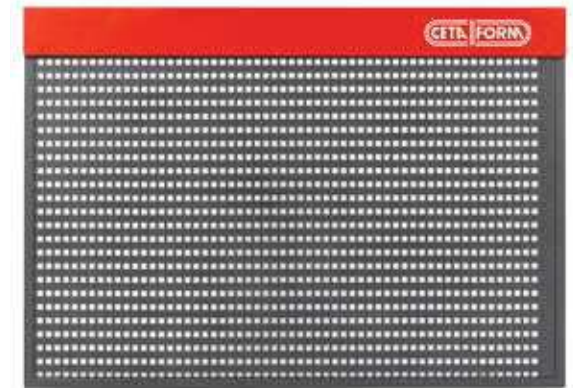

## A01-PS

### Perforated Tool Panel for GT-PLUS Series

**new**

- Euro perforation
- Compatible with standard width GT-PLUS cabinets (A01-06, 07, 08)

**Delivery without hooks, please order separately**



CODE NO	HxW / mm	kg
A01-PS	600 x 630	5

## A01-PM

### Perforated Tool Panel for GT-PLUS Series - Jumbo

**new**

- Euro perforation
- Compatible with GT-PLUS Jumbo cabinets (A01-07J, 08J)
- Delivery without any accessories or tools

**Delivery without hooks, please order separately**



CODE NO	HxW / mm	kg
A01-PM	600 x 806	6.5

## A01-PL

### Perforated Tool Panel for GT-PLUS Series - XL

**new**

- Euro perforation
- Compatible with XL width GT-PLUS cabinets (A01-06W, 06WW)

**Delivery without hooks, please order separately**



CODE NO	HxW / mm	kg
A01-PL	610 x 990	7.7

## A17H Series

### Hooks for Perforated Panels

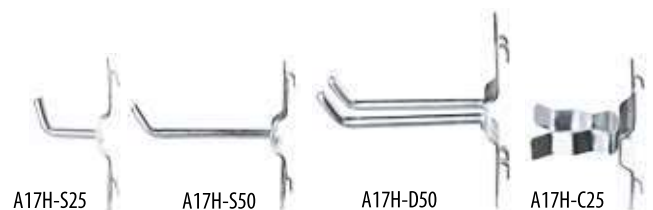

- Particularly for use on side and rear tool panels of tool cabinets and panels for workbenches, suitable for Euro perforations

CODE NO	L / mm	Ø / mm	
A17H-S25	25	-	12•
A17H-S50	50	-	12•
A17H-D50	50	-	12•
A17H-C25	-	25	12•

# 01 Tool Containers and Assortments

## Accessories

### A01M-LD

**new**

#### Lateral Door for GT-MAX Series (Lockable)

- For right side panel on GT-MAX and GT-MAX Jumbo Series (A01M-06,07,08 and A01M-07J, 08J)
- 95 mm clear depth and approximately 750 mm usable height



CODE NO

A01M-LD



1

### A01M-DH

**new**

#### Document Holder for GT-MAX Series

- For right side panel on GT-MAX and GT-MAX Jumbo Series (A01M-06,07,08 and A01M-07J, 08J)
- For A4 size documents



CODE NO

A01M-DH



1

### A01M-CH

**new**

#### Spray Can Holder for GT-MAX Series

- For right side panel on GT-MAX and GT-MAX Jumbo Series (A01M-06,07,08 and A01M-07J, 08J)



CODE NO

A01M-CH



1

### A01-PM Series

**new**

#### PVC Mat for Cabinet Worktops

- **A01-PM/S:** For standard width GT-PLUS Series
- **A01-PM/XL:** For XL width GT-PLUS Series
- **A02-PM/S:** For GT Series
- Textured design



CODE NO

A01-PM/S

HxW / mm

445 x 735



1

A01-PM/XL

445 x 1100

1

A02-PM/S

445 x 625

1

### A01M-PR

**new**

#### Paper Reel Holder for GT-MAX Series

- For right side panel on GT-MAX and GT-MAX Jumbo Series (A01M-06,07,08 and A01M-07J, 08J)
- For paper reels with a  $\varnothing$  up to 300 mm and width up to 290 mm
- Delivery without paper reel



CODE NO

A01M-PR



1



## Spare Parts

### A-SL

Spare Lock

**new**



CODE NO	FOR	
A-SL	GT-MAX, GT-PLUS, GT Series	1

### A-SW100 Series

Spare Wheels - Ø100  
(for GT Series and A03-SD)

**new**



CODE NO	TYPE	Ø / mm	
A-SW100	Wheel only	100	1
A-SW100F	Fixed	100	1
A-SW100S	Swiveling	100	1
A-SW100SB	Swiveling with Brake	100	1

### A-SWS-01M

Spare Worktop (for GT-MAX Series)

**new**



CODE NO	HxWxD / mm	
A-SWS-01M	35x745x455	1

### A-SH

Spare Handle (for Roller Cabinets)

**new**



CODE NO	FOR	
A-SH	GT-MAX, GT-PLUS, GT Series	1

### A-SW125 Series

Spare Wheels - Ø125  
(for GT-MAX, GT-Plus Series and A03-ID)

**new**



CODE NO	TYPE	Ø / mm	
A-SW125	Wheel only	125	1
A-SW125F	Fixed	125	1
A-SW125S	Swiveling	125	1
A-SW125SB	Swiveling with Brake	125	1

### A-SWJ-01M

Spare Worktop (for GT-MAX Jumbo Series)

**new**



CODE NO	HxWxD / mm	
A-SWJ-01M	35x920x455	1

# 01 Tool Containers and Assortments



## Tool Chests

### A06-04

Tool Chest (Empty) - 4 Drawers

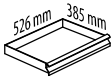

- Sturdy and dependable construction from heavy gauge steel
- Corrosion resistant and scratch-proof mat powder coated
- 80 mm deep top locker with integrated locking mechanism
- Low friction telescopic ball-bearing slides allowing 100% opening of drawers
- Load capacity per drawer: 25 kg
- Easily fits onto GT and GT-PLUS cabinets allowing capacity expansion
- Integrated carrying handles



CODE NO	HxWxD / mm		
A06-04	492 x 625 x 442	<b>4 Drawer</b> 3x type1, H: 70 mm 1x type2, H: 90 mm	35

### A06-04JS

Jumbo Tool Chest (Empty) - 4 Drawers

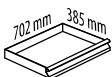

- All structural specs same as A06-04 but with different dimensions
- Easily fits onto GT-PLUS Jumbo cabinets allowing capacity expansion

CODE NO	HxWxD / mm		
A06-04JS	492 x 800 x 442	<b>4 Drawer</b> 3x type1, H: 70 mm 1x type2, H: 90 mm	42

### A06-08JX

Jumbo Tool Chest (Empty) - 8 Drawers

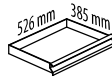
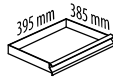

- All structural specs same as A06-04 but with different dimensions and more drawers
- Easily fits onto GT-PLUS A01-06W cabinets allowing capacity expansion

CODE NO	HxWxD / mm		
A06-08JX	492 x 1075 x 442	<b>4 Drawer</b> 3x type1, H: 70 mm 1x type2, H: 90 mm	<b>4 Drawer</b> 3x type3, H: 70 mm 1x type4, H: 90 mm

### A06-CT

Caddy Trolley (for Tool Chests)



- Sturdy and dependable construction from heavy gauge steel
- Particularly for use with tool chests A06-04 and A06-04JS
- Two fixed and 2 swiveling (one with brake) wheels, Ø100 mm
- Convenient fold-away handle
- Worktop covered with a PVC mat
- Maximum static load capacity: 350 kg

CODE NO	HxWxD / mm	
A06-CT	165 x 810 x 450	12

## Tool Boxes

### A07-02

Tool Box (Empty) - 2 Drawers

new  
design



- Sturdy and dependable construction from heavy gauge steel
- Corrosion resistant and scratch-proof mat powder coated
- 95 mm deep top locker with integrated locking mechanism
- Low friction telescopic ball-bearing slides allowing 100% opening of drawers
- Extra latches for added security
- Carrying handles, dip coated
- Internal dimensions of drawers: 485x200x45 x1, 485x200x55 x1

CODE NO	HxWxD / mm	
A07-02	250 x 565 x 255	1

### A07-03

Tool Box (Empty) - 3 Drawers

new  
design



- All structural specs same as A07-02 but with different dimensions and more drawers
- Internal dimensions of drawers: 485x200x45 x2, 485x200x55 x1

CODE NO	HxWxD / mm	
A07-03	300 x 565 x 255	1

### A07-0301

Aerospace Tool Box (Empty) - 3 Drawers

new



- Sturdy and dependable construction from heavy gauge steel
- Corrosion resistant and scratch-proof mat powder coated
- Textured Aluminium sheeting on the lid, galvanized steel reinforcement at the bottom part
- 95 mm deep top locker and integrated extra storage area under the lid
- Low friction telescopic ball-bearing slides allowing 100% opening of drawers
- High quality latches and extra lock bar to secure all drawers with a padlock
- Carrying handles, dip coated
- Internal dimensions of drawers: 485x200x45 x2, 485x200x55 x1

CODE NO	HxWxD / mm	
A07-0301	310 x 560 x 230	1

### A25 Series

Cantilever Tool Boxes



- Foldout construction for easy access to the tools in the box
- Large storage capacity
- Dependable sheet steel construction, scratch-proof powder coated
- Padlock clasp (delivery without padlock)

CODE NO	WxHxD / mm	TRAYS	
A25-3	420 x 145 x 200	3	1
A25-5	420 x 195 x 200	5	1
A25-5L	510 x 195 x 200	5	1
A25-5XL	600 x 195 x 200	5	1

# 01 Tool Containers and Assortments

## RAPTOR TOOL CASE PROGRAMME



Ceta Form has introduced a new tool case programme for professionals working in challenging conditions. Look after your tools with Raptor – a highly versatile case for technicians, engineers and maintenance operatives.

IP67

- ✓ Waterproof design
- ✓ Customizable tool fixing system
- ✓ Impact resistant material
- ✓ Stackability
- ✓ Soft grip handle

### A32 Tool Case

### A32H Tool Case (Mobility)



CODE NO

WxHxD / mm



A32

530 x 400 x 180

1

CODE NO

WxHxD / mm



A32H

530 x 400 x 230

1

# CETA FORM Technician's Tool Bags

High mobility for field technicians



## DURABLE | LIGHT-WEIGHT | HIGH-CAPACITY

Developed in collaboration with industry and trade professionals, these new tool bags offer leading performance, durability and strength.

Despite their lightweights, each bag offers a substantial capacity. Truly smarter by design and build quality.

## A26-ET01

### Technician's Tool Bag - Plus

- Made of high strength polyester fabric
- Fold-out front pouch allows for easy access to tools
- Large selection of tool and pen pouches in the front section
- Extra removable tool panel in front section with tool pouches and elastic loops
- Lined inside pouch for laptop and DIN A4 documents
- Water splash protected bottom
- Shoulder strap and two carry loops



CODE NO	WxHxD / mm	
A26-ET01	440 x 340 x 200	1

# 01 Tool Containers and Assortments

## Textile Tool Bags

### A26-IT01

#### Technician's Tool Bag

- Made of high strength polyester fabric
- Easily accessible front section with a large selection of tool pouches and elastic loops
- Back inside section for laptop and DIN A4 documents
- Extra rear and front pockets with zipper
- Water splash protected bottom
- Shoulder strap and two carry loops



CODE NO	WxHxD / mm	
A26-IT01	460 x 340 x 150	1

### A26-BP01

#### Technician's Backpack

- Made of high strength polyester fabric
- Easily accessible front section with a large selection of tool pouches
- Back inside section for laptop and DIN A4 documents
- Water splash protected bottom
- Extra side and front pockets
- Adjustable chest and waist strap
- Padded back for increased comfort



CODE NO	WxHxD / mm	
A26-BP01	355 x 460 x 225	1

## Textile Tool Bag / Plastic Tool Box

### A26-TB19

#### Tool Bag – Maxi

- Made of high strength polyester fabric
- Generous interior storage area for bulky tools
- Exterior and interior tool pockets
- Extra exterior pockets with zipper
- Water splash protected bottom
- Shoulder strap and two carry loops



CODE NO	WxHxD / mm	
A26-TB19	500 x 280 x 260	1

### A27-19PL

#### Plastic Tool Box - 19"

- Compact dimensions with highest possible storage capacity
- Two organizers on top with lids
- Removable tote tray
- Sturdy plastic latches
- Padlock clasp (padlock not supplied)



CODE NO	WxHxD / mm	
A27-19PL	494 x 263 x 250	8•



# 01 Tool Containers and Assortments

## Tool Sets

### A50M-98A07

### 98 Piece Mechanic's Tool Set

98 PIECE

- The perfect tool kit for professional mechanics in the industry and trade
- All tools in the set are genuine industrial quality unlike most other combination tool kits on the market
- Delivered in 3 drawer tool box A07-03
- All tools in foam inlays



CODE NO	PIECES	WxHxD / mm
A50M-98A07	98	300x565x255



**B01 12 PC**  
6, 7, 8, 9, 10, 11, 12, 13, 14, 17, 19, 22 mm



**LT/900 9 PC**  
1.5, 2, 2.5, 3, 4, 5, 6, 8, 10 mm



**LT/700L 8 PC**  
T9, T10, T15, T20, T25, T27, T30, T40



**C02-H 12 PC**  
4, 5, 5.5, 6, 7, 8, 9, 10, 11, 12, 13, 14 mm



**C22-H 18 PC**  
8, 10, 11, 12, 13, 14, 15, 16, 17, 18, 19, 20, 21, 22, 24, 27, 30, 32 mm



**C01-80**  
38 mm



**C21-80**



**C01-40**



**C01-70 2 PC**  
50 mm, 150 mm



**C21-40**



**C21-70 2 PC**  
125 mm, 250 mm



**C01-12**



**C21-12**



**C01-20**



**F10 4 PC**  
3, 4, 5.5, 6.5 mm



**F14 2 PC**  
PH1, PH2



**6105CP**  
3 mm



**E01-41-0180**  
180 mm



**E06-41-0160**  
160 mm



**E15-41-0160**  
160 mm



**F13-055-025**  
5.5 x 25 mm



**F16-002-025**  
PH2 x 25 mm



**L25-200-2**  
24 mm



**L29-4**  
4 mm



**L31 4 PC**  
3, 4, 5, 6 mm



**P05-0519**  
5M x 19 mm



**P15 2 PC**  
15, 30 cm

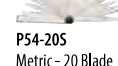

**P54-205**  
Metric - 20 Blade



**L01-500**  
500 gr



**L12-40**  
Ø 40 mm



**E50-240-2**  
240 mm



**E30-54-0250**  
250 mm



**R15-MPL**



**J45CPM**  
18 mm

Tool Sets

# A50AS-159A07

## 159 Piece Aerospace Tool Set

159 PIECE

new



- The perfect tool kit for aircraft mechanics
- All tools in the set are genuine industrial quality
- Delivered in 3 drawer tool box A07-0301 developed particularly for the aerospace industry
- All tools in foam inlays

CODE NO	PIECES	WxHxD / mm
A50AS-159A07	159	310 x 560 x 230



**B01AS**  
7/32 inch



**B01A 15 PC**  
1/4, 9/32, 5/16, 11/32, 3/8, 7/16, 1/2, 9/16, 5/8, 11/16, 3/4, 13/16, 7/8, 15/16, 1 inch



**B09SA 9 PC**  
15/64, 5/16, 9/32, 11/32, 1/4, 7/32, 3/8, 1/2, 7/16 inch



**B07A 3 PC**  
1/4x5/16, 3/8x7/16, 1/2x9/16 inch



**F26/BR2**



**C02A-B 10 PC**  
3/16, 7/32, 1/4, 9/32, 5/16, 11/32, 3/8, 7/16, 1/2, 9/16 inch



**C04A-B 10 PC**  
3/16, 7/32, 1/4, 9/32, 5/16, 11/32, 3/8, 7/16, 1/2, 9/16 inch



**C02UA 9 PC**  
7/32, 1/4, 9/32, 5/16, 3/8, 11/32, 7/16, 1/2, 9/16 inch



**C08AS-H 11 PC**  
1/16, 5/64, 3/32, 7/64, 1/8, 9/64, 5/32, 3/16, 7/32, 1/4, 5/16 inch



**C01-T90**



**C01-70 4 PC**  
50, 75, 100, 150 mm



**C01-75F**  
150 mm



**C12A-B 13 PC**  
1/4, 5/16, 3/8, 7/16, 1/2, 9/16, 5/8, 11/16, 3/4, 13/16, 7/8, 15/16, 1 inch



**C14A-B 13 PC**  
1/4, 5/16, 3/8, 7/16, 1/2, 9/16, 5/8, 11/16, 3/4, 13/16, 7/8, 15/16, 1 inch



**C11-T90**



**C11-36MR**  
215 mm



**C11-50MR**  
420 mm



**C11-70 3 PC**  
75, 150, 250 mm



**C11-80**



**E01-44-0160**  
160 mm



**E06-44-0160**  
160 mm



**E15-44-0160**  
160 mm



**B21-B 2 PC**  
150 mm, 250 mm



**E50-2 2 PC**  
140 mm, 240 mm



**E30-54**  
250 mm



**E80-230R**  
230 mm



**F26/RDS 12 in 1**



**F10 2 PC**  
5.5, 12 mm



**F14**  
PH2



**Z/12**



**Z/55**



**K99-F2M 9 PC**  
0.05, 1/16, 5/64, 3/32, 7/64, 1/8, 9/64, 5/32, 3/16 inch



**L12-40**  
Ø 40 mm



**L35A-51 5 PC**  
Chisel and Punch Set - US Spec.



**R20R**  
Ø 50 - 25/90cm



**R15-1000**  
1000 gr



**R16-700**  
700 gr



**R36-1**



**L02-12**  
340 gr



**3100/TF2**



**BT/8003**



**C01-92**  
F:1/4" - M:3/8 mm



**C11-91**  
F:3/8" x M:1/4"



**R.P6**  
250 lumens

# 01 Tool Containers and Assortments



## Tool Sets

### A50M-43

43 PIECE

### 43 Piece Mechanic's Tool Set

- The perfect tool kit for professional mechanics in the industry and trade
- All tools in the set are of genuine industrial quality unlike most other combination tool kits on the market
- Available in different tool boxes and tool cases

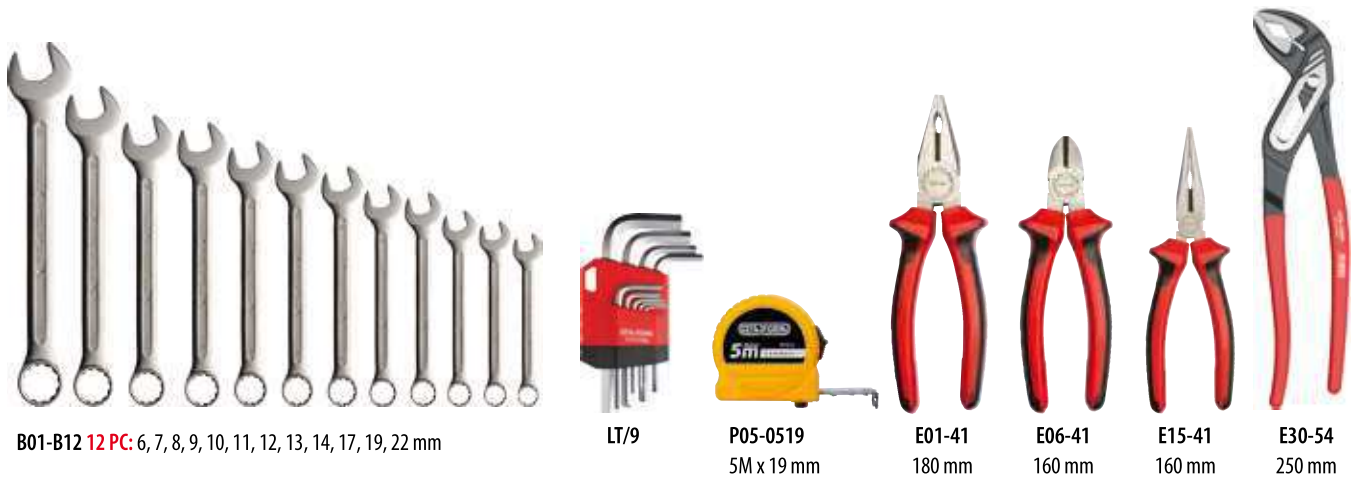

B01-B12 12 PC: 6, 7, 8, 9, 10, 11, 12, 13, 14, 17, 19, 22 mm

LT/9

P05-0519  
5M x 19 mm

E01-41  
180 mm

E06-41  
160 mm

E15-41  
160 mm

E30-54  
250 mm



L01  
500 gr



J45C  
18 mm



L35-61

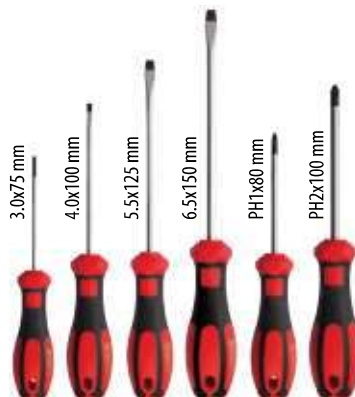

3.0x75 mm  
4.0x100 mm  
5.5x125 mm  
6.5x150 mm  
F10

PH1x80 mm  
PH2x100 mm  
F14



6105CP



R15-MPL



Padlock

### 43 Piece Tool Set

### Sets in Tool Boxes

Contents Only



(A50M-43+A25-5L)



(A50M-43+A27-19PL)



(A50M-43+A32)



(A50M-43+A32H)



CODE NO A50M-43

A50M-43A25

A50M-43A27

A50M-43A32

A50M-43A32H

# 01 Tool Containers and Assortments



Tool Sets

## G99-0431

## 31 PIECE

### 31 Piece Electrician Tool Set

- The perfect tool kit for professional electricians in the industry and trade
- All tools in the set are of genuine industrial quality unlike most other combination tool kits on the market
- Available in different tool boxes and tool cases



G10-18 180 mm  
G12-18 160 mm  
G15-18 160 mm  
G30-58 170 mm

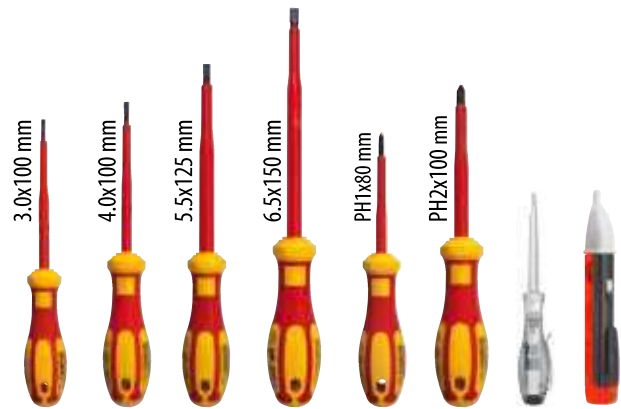

3.0x100 mm  
4.0x100 mm  
5.5x125 mm  
6.5x150 mm  
PH1x80 mm  
PH2x100 mm  
G01  
G02  
6105CP  
G09-NC1



J36 150 mm  
L01 500 gr  
L25-200-2 200 mm  
P05-0519 5M x 19 mm  
J45C 18 mm  
F26-RDS 12 in 1  
E25-CK28  
E25-AS06

#### 31 Piece Tool Set

#### Sets in Tool Boxes

Contents Only

(G99-0431+A26-TB19)

(G99-0431+A27-19PL)

(G99-0431+A32)

(G99-0431+A32H)



CODE NO G99-0431

G99-0431A26

G99-0431A27

G99-0431A32

G99-0431A32H

# 01 Tool Containers and Assortments



Tool Sets

## A50M-75PH2

75 PIECE

### 75 Piece Universal Tool Set

- The perfect tool kit for professional users in the industry and trade
- All tools in the set are genuine industrial quality unlike most other combination tool kits on the market
- Rigid and durable high density Polyethylene (HDPE) case



CODE NO	PIECES	WxHxD / mm
A50M-75PH2	75	440x320x100



C22-H 10 PC   
8, 10, 11, 12, 13, 14, 17, 19, 22, 24 mm



C21-80



C11-92   
F:3/8" x M:1/2"



C21-70 2 PC   
125 mm, 250 mm



C21-14



E01-41-0180  
180 mm



E30-54-0250  
250 mm



B01 8 PC  
8, 10, 11, 12, 13, 14, 17, 19 mm



B21-BU  
200 mm



J45C  
18 mm



LT/9 9 PC   
1.5, 2, 2.5, 3, 4, 5, 6, 8, 10 mm



L01-500  
500 gr



P05-0519  
5M x 19 mm



F10 2 PC   
4, 5, 5 mm



F14 2 PC   
PH1, PH2



6105CP   
3 mm



F26/BT



CB/ST31 31 PC

CFS



700x370 mm



# CETA FORM Tool Modules

Traceability and efficiency at its best

Today's complex MRO and manufacturing environments require intelligent tool storage systems. Particularly in aerospace and automotive industries, this necessity is even higher.

The Ceta Form Foam System (CFS) addresses these requirements in a perfect way. It ensures that no tool is left where it may pose a security risk. Therefore the highest degree of traceability and efficiency is guaranteed.

Get organized and have full control over your tools with CFS tool modules.



175x370 mm



350x370 mm



525x370 mm



700x370 mm

Finger spaces for easy removal of tools

Choose from almost 100 variants of modules or let us design to your specific configuration

The use of two color allows the user to instantly detect a missing tool

Chemically resistant, durable yet flexible foam inlays

## CFS

### B99-E41

41 Piece Wrench Set

new

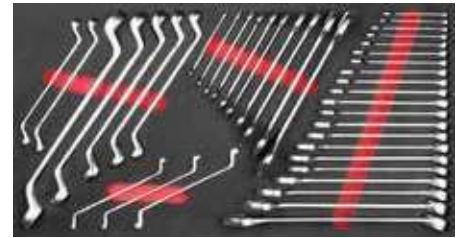

CODE NO	PIECES
B99-E41	41
B01	21 PC: 6, 7, 8, 9, 10, 11, 12, 13, 14, 15, 16, 17, 18, 19, 20, 21, 22, 24, 27, 30, 32 mm Combination Wrenches
B09	10 PC: 6x7, 8x9, 10x11, 12x13, 14x15, 16x17, 18x19, 20x22, 24x27, 30x32 mm Double Open End Wrenches
B14	10 PC: 6x7, 8x9, 10x11, 12x13, 14x15, 16x17, 18x19, 20x22, 24x27, 30x32 mm Double Ring End Wrenches

### EL-E34

34 Piece Tool Set

new



CODE NO	PIECES
EL-E34	34
E01-41	180 mm Combination Pliers
E06-41	160 mm Diagonal Cutter
E15-41	200 mm Long Nose Pliers
E16-41	200 mm Bent Long Nose Pliers
E30-54	250 mm Water Pump Pliers (Box Joint)
E50-2	240 mm Grip Pliers (Curved Jaws)
E65-44	180 mm External Circlip Pliers (Straight-with Spring)
E66-44	180 mm External Circlip Pliers (Bent-with Spring)
E67-44	180 mm Internal Circlip Pliers (Straight-without Spring)
E68-44	180 mm Internal Circlip Pliers (Bent-without Spring)
N12-10	Hose Clamp Pliers (for Spring Band Hose Clamps)
J45CPM	C-Pro Utility Knife (Metal Body) - 18 mm
J45-R	10 PC: 18 mm Utility Knife Blade
L01-500	Machinist's Hammer - 500 gr
L12-40	Soft Face Hammer- Ø40 mm
L12-R40	Spare Plastic Heads (for L12-40) - Single
L25-200-2	Flat Chisel - 24x 200 mm
L29-4	Centre Punch - Ø4 x 120 mm
L31	4 PC: Ø(3, 4, 5, 6) x 150 mm Parallel Pin Punch
P05-0519	Compact Tape Measure (5 M x 19 mm)
P15-030	Stainless Steel Rule- 30 cm
P54-205	Feeler Gauge (Metric) - 20 Leaf (0,05 - 1,0 mm)

# 01 Tool Containers and Assortments

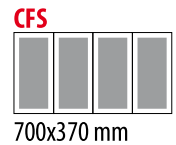

## F99-E95

95 Piece Screwdriver and L/T Key Set

**new**



CODE NO	PIECES
F99-E95	95

F10	4 PC: 3x75, 4x100, 5.5x125, 6.5x150 mm C-PLUS Slotted Screwdrivers
F14	2 PC: PH1x80, PH2x100 mm C-PLUS Phillips Screwdrivers
F13	5.5x25 mm C-PLUS Slotted Stubby Screwdriver
F16	PH2x25 mm C-PLUS Phillips Stubby Screwdriver
F18	7 PC: T10x80, T15x80, T20x100, T25x100, T27x115, T30x115, T40x130 mm C-PLUS TORX Screwdrivers
F20	5 PC: (6, 7, 8, 10, 13)x125 mm C-PLUS Nut Drivers
H01	4 PC: 1.5x40, 2x60, 2.5x80, 3x80 mm Electronics Slotted Screwdrivers
H02	2 PC: PH00x60, PH0x60 mm Electronics Phillips Screwdrivers
K10	6 PC: 2x100, 2.5x100, 3x100, 4x150, 5x150, 6x200 mm T-Handle Hexagon Key
LT/900	9 PC: 1.5, 2, 2.5, 3, 4, 5, 6, 8, 10 mm Ball End Hexagon L Key Set (Long Arm)
LT/700L	8 PC: T9, T10, T15, T20, T25, T27, T30, T40 TORX L Key Set (Long Arm)
F26/BT	C-PLUS Bit Driver - 1/4" x 100 mm
CB/ST31	31 PC: Slotted/PH/PZ/TORX/Hex. Bits, BT/02 Bit Holder
F26/RDS	12-in-1: Stubby Ratchet Bit Driver Set
F26/BR2	Reversible Bit Ratchet#2 - 1/4" x 90 mm
6105CP	Voltage Tester (for 110 to 250V-VDE Approved)

## KNR-E37

37 Piece Tool Set

**new**



CODE NO	PIECES
KNR-E37	37

K20	4 PC: (7, 8, 10, 13)x125 mm T-Handle Nut Drivers
K10	6 PC: 2x100, 2.5x100, 3x100, 4x150, 5x150, 6x200mm T-Handle Hexagon Keys
K12	7 PC: T10x100, T15x100, T20x150, T25x150, T27x150, T30x150, T40x150 mm T-Handle TORX Keys
N12-05	Antifreeze Tester - 200 mm
N14-061S	Oil Filter Band Wrench - Ø 60-100 mm
N14-06R	4 PC: Spare Strap (for N14-061S)
N21-10	Brake Caliper Brush - 220 mm
N31-110S	5 PC: Trim and Upholstery Removal Set
N31-12	Trim Clip Removal Tool - 150 mm
R11-PEN	Stylus LED Flashlight - 100 lumen
R15-1000	Magnetic Pick-Up Tool (Cap.: 1000 gr)
R36-1	Straight Pick
R36-2	Angle Pick
R36-3	90° Pick
R36-4	Hook Pick
R37-25	Seal Scraper - 25 x 150 mm

## JLR-E62

62 Piece Tool Set

**new**



CODE NO	PIECES
JLR-E62	62

J55-108H	Hand File (Bastard) - 20 x 200 mm
J56-108H	Half-Round File (Bastard) - 20 x 200 mm
J57-108H	Round File (Bastard) - Ø7.5 x 200 mm
J58-108H	Square File (Bastard) - 8 x 200 mm
J59-108H	Three Square File (Bastard) - 15 x 200 mm
J75-R06	6 PC: Needle File Set
J45CPM	C-Pro Utility Knife (Metal Body) - 18 mm
J45-R	10 PC: Utility Knife Blade - 18 mm
L01-500	Machinist's Hammer - 500 gr
L12-40	Soft Face Hammer - Ø 40 mm
L12-R40	Spare Plastic Head - Ø 40 mm (Single)
L25-200-2	Flat Chisel - 24x 200 mm
L29-4	Centre Punch - Ø4 x 120 mm
L31	4 PC: Ø(3, 4, 5, 6) x 150 mm Parallel Pin Punch
P05-0519	Compact Tape Measure (5 M x 19 mm)
P15-030	Stainless Steel Rule- 30 cm
P54-20S	Feeler Gauge (Metric) - 20 Leaf (0,05 - 1,0 mm)
R11-PEN	Stylus LED Flashlight -100 lumen
R15-1000	Magnetic Pick-Up Tool (Cap.: 1000 gr)
R21-P19	19 PC: 1, 1.5, 2, 2.5, 3, 3.5, 4, 4.5, 5, 5.5, 6, 6.5, 7, 7.5, 8, 8.5, 9, 9.5, 10 mm HSS Drill Bit Set
R35CT	Carbide Tipped Scriber- 145 mm
R36-1	Straight Pick
R36-2	Angle Pick
R36-3	90° Pick
R36-4	Hook Pick
R37-25	Seal Scraper - 25 x 150 mm
R40-4	Steel Wire Brush (4 Row) - 275 mm

## CF-E105

105 Piece Screwdriver and 1/2" Drive Socket Bit Set

**new**

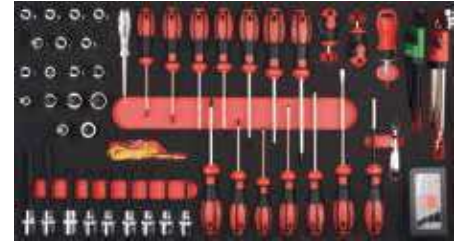

CODE NO	PIECES
CF-E105	105

F10	4 PC: 3.0x75, 4.0x100, 5.5x125, 6.5x150 mm C-PLUS Slotted Screwdrivers
F14	2 PC: PH1x80, PH2x100 mm C-PLUS Phillips Screwdrivers
F13	5.5 x 25 mm C-PLUS Slotted Stubby Screwdriver
F16	PH2 x 25 mm C-PLUS Phillips Stubby Screwdriver
F18	7 PC: T10x80, T15x80, T20x100, T25x100, T27x115, T30x115, T40x130 C-PLUS TORX Screwdrivers
F26/BT	Bit Driver - 1/4" x 100 mm
CB/ST31	31 PC: Slotted/PH/PZ/TORX/Hex. Bits, BT/02 Bit Holder
F26/RDS	12-in-1: Stubby Ratchet Bit Driver Set
F26/BR2	Reversible Bit Ratchet#2 - 1/4" x 90 mm
6105CP	Voltage Tester (for 110 to 250V-VDE Approved)
G09-11	Car Electric Circuit Tester - 6/24 DC (V)
LT/900	9 PC: 1.5, 2, 2.5, 3, 4, 5, 6, 8, 10 mm Ball End Hexagon L Key Set (Long Arm)
LT/700L	8 PC: T9, T10, T15, T20, T25, T27, T30, T40 TORX L Key Set (Long Arm)
C28S-H	7 PC: (5, 6, 7, 8, 10, 12, 14) x 30 mm 1/2" Drive Hexagon Socket Bits - Short
C28S-T	9 PC: (T20, T25, T27, T30, T40, T45, T50, T55, T60) x 55mm 1/2" Drive TORX Socket Bits- Short
C28S-TL	4 PC: (T30, T40, T45, T50) x 100 mm 1/2" Drive TORX Socket Bits- Long
C28S-XL	2 PC: (M6, M8) x 100 mm 1/2" Drive XZN Socket Bits - Long
C28S-XXL	2 PC: (M10, M12) x 140 mm 1/2" Drive XZN Socket Bits - Extra Long
C28S-X14L	M14 x 100 mm 1/2" Drive XZN Socket Bits - Long
C28S-X16	M16 x 55 mm 1/2" Drive XZN Socket Bits - Short

**B99-E24**

24 Piece Combination and Double Open End Wrench Set

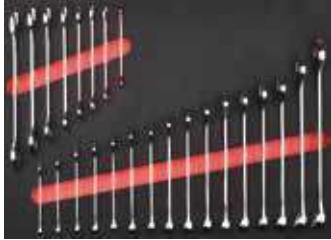
**new**

CODE NO	PIECES
B99-E24	24

- B01** 16 PC: 6, 7, 8, 9, 10, 11, 12, 13, 14, 15, 16, 17, 18, 19, 22, 24 mm Combination Wrenches  
**B09** 8 PC: 6x7, 8x9, 10x11, 12x13, 14x15, 16x17, 18x19, 20x22 mm Double Open End Wrenches

**B99-E241**

24 Piece Combination and Double Ring End Wrench Set

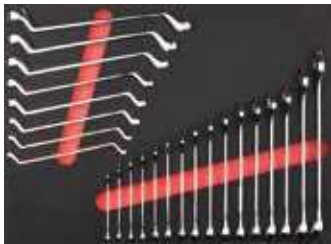
**new**

CODE NO	PIECES
B99-E241	24

- B01** 16 PC: 6, 7, 8, 9, 10, 11, 12, 13, 14, 15, 16, 17, 18, 19, 22, 24 mm Combination Wrenches  
**B14** 8 PC: 6x7, 8x9, 10x11, 12x13, 14x15, 16x17, 18x19, 20x22 mm Double Ring End Wrenches

**B99-E32**

32 Piece Wrench Set

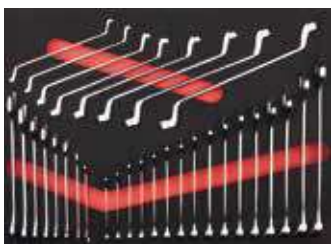
**new**

CODE NO	PIECES
B99-E32	32

- B01** 16 PC: 6, 7, 8, 9, 10, 11, 12, 13, 14, 15, 16, 17, 18, 19, 22, 24 mm Combination Wrenches  
**B09** 8 PC: 6x7, 8x9, 10x11, 12x13, 14x15, 16x17, 18x19, 20x22 mm Double Open End Wrenches  
**B14** 8 PC: 6x7, 8x9, 10x11, 12x13, 14x15, 16x17, 18x19, 20x22 mm Double Ring End Wrenches

**B99A-E26**

26 Piece Combination and Double Open End Wrench Set- SAE

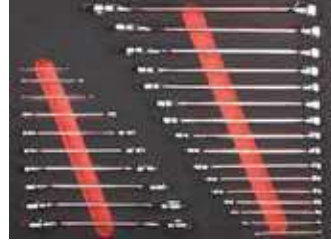
**new**

CODE NO	PIECES
B99A-E26	26

- B01A** 16 PC: 1/4, 5/16, 3/8, 7/16, 1/2, 9/16, 5/8, 11/16, 3/4, 13/16, 7/8, 15/16, 1, 1 1/16, 1 1/8, 1 1/4 inch Combination Wrenches - SAE  
**B09A** 10 PC: 1/4x5/16, 5/16x3/8, 7/16x1/2, 1/2x9/16, 9/16x5/8, 5/8x3/4, 11/16x3/4, 13/16x7/8, 15/16x1, 1-1/16x1-1/8 inch Double Open End Wrenches - SAE

**B99A-E31**

31 Piece Wrench Set - SAE

**new**

CODE NO	PIECES
B99A-E31	31

- B01AS** 7/32 inch Combination Wrench (12 Point - Short) - SAE  
**B01A** 15 PC: 1/4, 9/32, 5/16, 11/32, 3/8, 7/16, 1/2, 9/16, 5/8, 11/16, 3/4, 13/16, 7/8, 15/16, 1 inch Combination Wrenches - SAE  
**B07A** 4 PC: 1/4x5/16, 5/16x11/32, 3/8x7/16, 1/2x9/16 inch Ratchet Ring Wrenches (Straight)-SAE  
**B09SA** 9 PC: 7/32, 15/64, 1/4, 9/32, 5/16, 11/32, 3/8, 7/16, 1/2 inch Short Angle Open End Wrenches - SAE  
**B21-B** 2 PC: 150, 250 mm Adjustable Wrenches (Phosphated)

**BC-E08**

8 Piece Tool Set

**new**

CODE NO	PIECES
BC-E08	8

- B01** 3 PC: 27, 30, 32 mm Combination Wrenches  
**B14** 2 PC: 24x27, 30x32 mm Double Ring End Wrenches  
**C21-79W** 1/2" Drive Wobble Extension Bar - 500 mm  
**C31-40** 3/4" Drive Sliding T-Handle- 500 mm  
**N23-0750** Tyre Lever - 500 mm

**BC-E081**

8 Piece Tool Set

**new**

CODE NO	PIECES
BC-E081	8

- B01** 3 PC: 27, 30, 32 mm Combination Wrenches  
**B14** 2 PC: 21x23, 24x26 mm Double Ring End Wrenches  
**C21-79W** 1/2" Drive Wobble Extension Bar - 500 mm  
**C31-40** 3/4" Drive Sliding T-Handle- 500 mm  
**N23-0750** Tyre Lever - 500 mm

**BC-E40**

40 Piece C-GEAR Ratcheting Combination Wrench and 1/2" Drive Socket Bit Set

**new**

CODE NO	PIECES
BC-E40	40

- B05** 6 PC: 8, 10, 12, 13, 17, 19 mm C-GEAR Ratcheting Combination Wrenches (Straight)  
**B19** 10x11 mm Flare Nut Wrench  
**C28S-T** 8 PC: (T25, T27, T30, T40, T45, T50, T55, T60) x 55 mm 1/2" Drive TORX Socket Bits-Short  
**C28S-H** 9 PC: (5, 6, 7, 8, 10, 12, 14, 17, 19) x 55 mm 1/2" Drive Hexagon Socket Bits-Short  
**C28S-HBXL** 4 PC: (6, 7, 8, 10 mm) x 140 mm 1/2" Drive Ball End Hexagon Socket Bits - Extra Long  
**C28S-X** 7 PC: (M5, M6, M8, M10, M12, M14, M16) x 55 mm 1/2" Drive XZN Socket Bits- Short  
**C68-X18** M18 x 78 mm 1/2" Drive Impact XZN Socket Bit  
**C28S-XL** 2 PC: (M8, M14) x 100 mm 1/2" Drive XZN Socket Bits - Long  
**C28S-XXL** 2 PC: (M10, M12) x 140 mm 1/2" Drive XZN Socket Bits - Extra Long

**B99-E20**

20 Pc Combination and Double Open End Wrench Set

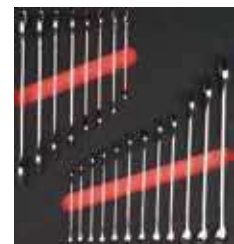
**new**

CFS



350x370 mm

CODE NO	PIECES
B99-E20	20

- B01** 12 PC: 6, 7, 8, 9, 10, 11, 12, 13, 14, 17, 19, 22 mm  
**B09** 8 PC: 6x7, 8x9, 10x11, 12x13, 14x15, 16x17, 18x19, 20x22 mm

# 01 Tool Containers and Assortments



## C99-E68H2

68 Piece 1/4" + 1/2" Drive 6-Point Socket Set

**new**



CODE NO	PIECES
C99-E68H2	68

- C02-H ○ **11 PC:** 4, 5, 5.5, 6, 7, 8, 9, 10, 11, 12, 13 mm 1/4" Drive 6-Point Socket
- C01-12 1/4" Drive Quick Release Reversible Ratchet
- C01-20 1/4" Drive Spinner Handle (120 mm)
- C01-40 1/4" Drive Sliding T-Handle (115 mm)
- C01-73 1/4" Drive Extension Bar (100 mm)
- C01-80 1/4" Drive Universal Joint
- F26/BT ○ C-PLUS Bit Driver - 1/4" x 100 mm
- BT/8001 ○ 1/4" Drive Bit Holder Socket (for 1/4" Bits)
- CB/610 ● **3 PC:** 4, 5, 5.5, 6.5 mm Slotted Bits
- CB/250 ⊕ **2 PC:** PH1, PH2 Phillips Bits
- CB/350 ⊕ **2 PC:** PZ1, PZ2 Pozidriv Bits
- CB/800 ⊕ **6 PC:** T10, T15, T20, T25, T30, T40 TORX Bits
- CB/1800 ⊕ **4 PC:** 3, 4, 5, 6 mm Hexagon Bits
- C22-H ○ **16 PC:** 10, 11, 12, 13, 14, 15, 16, 17, 18, 19, 21, 22, 24, 27, 30, 32 mm 1/2" Drive 6-Point Sockets
- C21-12 1/2" Drive Quick Release Reversible Ratchet
- C21-40 1/2" Drive Sliding T-Handle (250 mm)
- C21-70 **2 PC:** 125, 250 mm 1/2" Drive Extension Bar
- C21-80 1/2" Drive Universal Joint
- BT/8007 ○ 1/2" Drive Bit Holder Socket (for 5/16" Bits)
- CB/516SL ● 10 mm 5/16" Slotted Bit (Impact Grade)
- CB/516PH ⊕ **3 PC:** PH2, PH3, PH4 5/16" Phillips Bits (Impact Grade)
- CB/516TX ⊕ **4 PC:** T30, T40, T45, T50 5/16" TORX Bits (Impact Grade)
- CB/516HX ○ **3 PC:** 5, 6, 8 mm 5/16" Hexagon Bits (Impact Grade)

## C99A-E96BMR

96 Piece 1/4" + 1/2" Drive 12-Point Socket Set - SAE

**new**

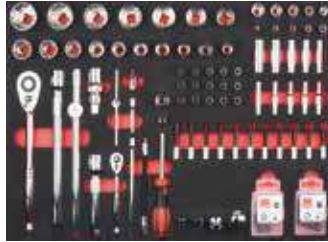

CODE NO	PIECES
C99A-E96BMR	96

- C02A-B ○ **10 PC:** 3/16, 7/32, 1/4, 9/32, 5/16, 11/32, 3/8, 7/16, 1/2, 9/16 inch 1/4" Drive 12-Point Sockets - SAE
- C04A-B ○ **10 PC:** 3/16, 7/32, 1/4, 9/32, 5/16, 11/32, 3/8, 7/16, 1/2, 9/16 inch 1/4" Drive 12-Point Deep Sockets - SAE
- C08S-S ● **3 PC:** 4, 5.5, 6.5 mm 1/4" Drive Slotted Socket Bits
- C08S-PH ⊕ **2 PC:** PH1, PH2 1/4" Drive Phillips Socket Bits
- C08S-PZ ⊕ **2 PC:** PZ1, PZ2 1/4" Drive Pozidriv Socket Bits
- C08S-T ⊕ **8 PC:** T8, T10, T15, T20, T25, T27, T30, T40 1/4" Drive TORX Socket Bits
- C08AS-H ○ **11 PC:** 1/16, 5/64, 3/32, 7/64, 1/8, 9/64, 5/32, 3/16, 7/32, 1/4, 5/16 inch 1/4" Drive Hexagon Socket Bits - SAE
- C01-T90 1/4" Drive T90 Sealed Reversible Ratchet
- C01-20 1/4" Drive Spinner Handle (150 mm)
- C01-40 1/4" Drive Sliding T-Handle (115 mm)
- C01-70 **2 PC:** 50, 150 mm 1/4" Drive Extension Bar
- C01-75F 1/4" Drive Flexible Extension Bar - 150 mm
- C01-80 1/4" Drive Universal Joint
- C01-92 1/4" Socket Adaptor - (F: 1/4" - M: 3/8")
- BT/8001 ○ 1/4" Drive Bit Holder Socket (for 1/4" Bits)
- CB/800T ⊕ **7 PC:** T10, T15, T20, T25, T27, T30, T40 1/4" TORX Tamper Resistant Bits
- C22A-B ○ **15 PC:** 3/8, 7/16, 1/2, 9/16, 5/8, 11/16, 3/4, 13/16, 7/8, 15/16, 1, 1-1/16, 1-1/8, 1-3/16, 1-1/4 inch 1/2" Drive 12-Point Sockets - SAE
- C21-T90 1/2" Drive T90 Sealed Reversible Ratchet
- C21-40 1/2" Drive Sliding T-Handle (250 mm)
- C21-70 **2 PC:** 125, 250 mm 1/2" Drive Extension Bar
- C21-80 1/2" Drive Universal Joint
- C21-91S 1/2" Drive Socket Adaptor (F: 1/2" - M: 3/8")
- C21-92 1/2" Drive Socket Adaptor (F: 1/2" - M: 3/4")
- BT/8007 ○ 1/2" Drive Bit Holder Socket (for 5/16" Bits)
- CB/516SL ● 10 mm 5/16" Slotted Bit (Impact Grade)
- CB/516PH ⊕ **3 PC:** PH2, PH3, PH4 5/16" Phillips Bits (Impact Grade)
- CB/516TX ⊕ **4 PC:** T30, T40, T45, T50 5/16" TORX Bits (Impact Grade)
- CB/516HX ○ **3 PC:** 5, 6, 8 mm 5/16" Hexagon Bits (Impact Grade)

## C99-E99H2

99 Piece 1/4" + 1/2" Drive 6-Point Socket Set

**new**



CODE NO	PIECES
C99-E99H2	99

- C02-H ○ **12 PC:** 4, 5, 5.5, 6, 7, 8, 9, 10, 11, 12, 13, 14 mm 1/4" Drive 6-Point Sockets
- C04-H ○ **11 PC:** 4, 5, 5.5, 6, 7, 8, 9, 10, 11, 12, 13 mm 1/4" Drive 6-Point Deep Sockets
- C08S-S ● **3 PC:** 4, 5, 5.5, 6.5 mm 1/4" Drive Slotted Socket Bits
- C08S-PH ⊕ **2 PC:** PH1, PH2 1/4" Drive Phillips Socket Bits
- C08S-PZ ⊕ **2 PC:** PZ1, PZ2 1/4" Drive Pozidriv Socket Bits
- C08S-T ⊕ **8 PC:** T8, T10, T15, T20, T25, T27, T30, T40 1/4" Drive TORX Socket Bits
- C08S-H ○ **5 PC:** 3, 4, 5, 6, 8 mm 1/4" Drive Hexagon Socket Bits
- C01-12 1/4" Drive Quick Release Reversible Ratchet
- C01-20 1/4" Drive Spinner Handle (150 mm)
- C01-40 1/4" Drive Sliding T-Handle (115 mm)
- C01-70 **2 PC:** 50, 150 mm 1/4" Drive Extension Bar
- C01-75F 1/4" Drive Flexible Extension Bar - 150 mm
- C01-80 1/4" Drive Universal Joint
- C01-92 1/4" Socket Adaptor - (F: 1/4" - M: 3/8")
- BT/8001 ○ 1/4" Drive Bit Holder Socket (for 1/4" Bits)
- CB/800T ⊕ **7 PC:** T10, T15, T20, T25, T27, T30, T40 TORX Tamper Resistant Bits
- C22-H ○ **18 PC:** 8, 10, 11, 12, 13, 14, 15, 16, 17, 18, 19, 20, 21, 22, 24, 27, 30, 32 mm 1/2" Drive 6-Point Sockets
- C24-H ○ **3 PC:** 13, 17, 19 mm 1/2" Drive 6-Point Deep Sockets
- C21-12 1/2" Drive Quick Release Reversible Ratchet
- C21-40 1/2" Drive Sliding T-Handle (250 mm)
- C21-70 **2 PC:** 125, 250 mm 1/2" Drive Extension Bar
- C21-80 1/2" Drive Universal Joint
- C21-91S 1/2" Drive Socket Adaptor (F: 1/2" - M: 3/8")
- C21-92 1/2" Drive Socket Adaptor (F: 1/2" - M: 3/4")
- BT/8007 ○ 1/2" Drive Bit Holder Socket (for 5/16" Bits)
- CB/516SL ● 10 mm 5/16" Slotted Bit (Impact Grade)
- CB/516PH ⊕ **3 PC:** PH2, PH3, PH4 5/16" Phillips Bits (Impact Grade)
- CB/516TX ⊕ **4 PC:** T30, T40, T45, T50 5/16" TORX Bits (Impact Grade)
- CB/516HX ○ **3 PC:** 5, 6, 8 mm 5/16" Hexagon Bits (Impact Grade)

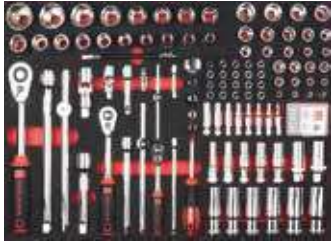

## C99-E115H2

115 Pc. 1/4"+3/8"+1/2" Drive 6-Point Socket Set **new**

CODE NO	PIECES
C99-E115H2	115
C02-H	12 PC: 4, 5, 5.5, 6, 7, 8, 9, 10, 11, 12, 13, 14 mm 1/4" Drive 6-Point Socket
C04-H	8 PC: 4, 5, 5.5, 6, 7, 8, 9, 10 mm 1/4" Drive 6-Point Deep Sockets
C08S-S	3 PC: 4, 5, 5.5, 6.5 mm 1/4" Drive Slotted Socket Bits
C08S-PH	2 PC: PH1, PH2 1/4" Drive Phillips Socket Bits
C08S-PZ	2 PC: PZ1, PZ2 1/4" Drive Pozidriv Socket Bits
C08S-T	8 PC: T8, T10, T15, T20, T25, T27, T30, T40 1/4" Drive TORX Socket Bits
C08S-H	5 PC: 3, 4, 5, 6, 8 mm 1/4" Drive Hexagon Socket Bits
C01-12	1/4" Drive Quick Release Reversible Ratchet
C01-20	1/4" Drive Spinner Handle (150 mm)
C01-40	1/4" Drive Sliding T-Handle (115 mm)
C01-70	2 PC: 50, 150 mm 1/4" Drive Extension Bar
C01-75F	1/4" Drive Flexible Extension Bar- 150 mm
C01-80	1/4" Drive Universal Joint
C01-92	1/4" Socket Adaptor- (F: 1/4" - M: 3/8")
BT/8001	1/4" Drive Bit Holder Socket (for 1/4" Bits)
CB/800T	7 PC: T10, T15, T20, T25, T27, T30, T40 TORX Tamper Resistant Bits
C12-H	14 PC: 8, 9, 10, 11, 12, 13, 14, 15, 16, 17, 18, 19, 21, 22 mm 3/8" Drive 6-Point Sockets
C14-H	5 PC: 11, 12, 13, 14, 15 mm 3/8" Drive 6-Point Deep Sockets
C11-12	3/8" Drive Quick Release Reversible Ratchet
C11-40	3/8" Drive Sliding T-Handle (200 mm)
C11-70	2 PC: 75, 150 mm 3/8" Drive Extension Bar
C11-80	3/8" Drive Universal Joint
C11-91	3/8" Socket Adaptor- (F: 3/8" - M: 1/4")
C11-92S	3/8" Socket Adaptor- (F: 3/8" - M: 1/2")
C22-H	18 PC: 8, 10, 11, 12, 13, 14, 15, 16, 17, 18, 19, 20, 21, 22, 24, 27, 30, 32 mm 1/2" Drive 6-Point Sockets
C24-H	6 PC: 16, 17, 18, 19, 22, 24 mm 1/2" Drive 6-Point Deep Sockets
C27-R	2 PC: 16, 21 mm 1/2" Drive Spark Plug Sockets (Retaining Rubber)
C21-12	1/2" Drive Quick Release Reversible Ratchet
C21-40	1/2" Drive Sliding T-Handle (250 mm)
C21-70	2 PC: 125, 250 mm 1/2" Drive Extension Bar
C21-80	1/2" Drive Universal Joint
C21-91S	1/2" Drive Socket Adaptor (F:1/2"- M:3/8")
C21-92	1/2" Drive Socket Adaptor (F:1/2"- M:3/4")

## C99-E95H2

95 Piece 1/4"+ 1/2" Drive 6-Point Socket Set **new**

CODE NO	PIECES
C99-E95H2	95
C02-H	12 PC: 4, 5, 5.5, 6, 7, 8, 9, 10, 11, 12, 13, 14 mm 1/4" Drive 6-Point Socket
C06	5 PC: E4, E5, E6, E7, E8 1/4" Drive E-TORX Sockets
C08S-S	5.5 mm 1/4" Drive Slotted Socket Bit
C08S-PH	2 PC: PH1, PH2 1/4" Drive Phillips Socket Bits
C08S-T	9 PC: T6, T7, T8, T9, T10, T15, T20, T25, T27 1/4" Drive TORX Socket Bits
C08S-H	4 PC: 3, 4, 5, 6 mm 1/4" Drive Hexagon Socket Bits
C01-12	1/4" Drive Quick Release Reversible Ratchet
C01-20	1/4" Drive Spinner Handle (150 mm)
C01-70	3 PC: 50, 100, 150 mm 1/4" Drive Extension Bar
C01-80	1/4" Drive Universal Joint
C01-92	1/4" Socket Adaptor- (F: 1/4" - M: 3/8")
C11-91	3/8" Socket Adaptor- (F: 3/8" - M: 1/4")
C11-92S	3/8" Socket Adaptor- (F: 3/8" - M: 1/2")
C22-H	17 PC: 10, 11, 12, 13, 14, 15, 16, 17, 18, 19, 20, 21, 22, 24, 27, 30, 32 mm 1/2" Drive 6-Point Sockets
C22-B	17 PC: 8, 9, 10, 12, 13, 14, 15, 16, 17, 18, 19, 21, 22, 24, 27, 30, 32 mm 1/2" Drive 12-Point Sockets
C26	6 PC: E10, E12, E14, E16, E18, E20 1/2" Drive E-TORX Sockets
C64W-H	2 PC: 17, 19 mm 1/2" Drive DuraMAX Impact Wheel Nut Socket
C21-12	1/2" Drive Quick Release Reversible Ratchet
C21-40	1/2" Drive Sliding T-Handle (250 mm)
C21-70W	3 PC: 50, 125, 250 mm 1/2" Drive Wobble Extension Bars
C21-80	1/2" Drive Universal Joint
C21-91S	1/2" Drive Socket Adaptor (F:1/2"- M:3/8")
C21-92	1/2" Drive Socket Adaptor (F:1/2"- M:3/4")
C31-91	3/4" Drive Socket Adaptor (F:3/4"- M:1/2)
C62-B	2 PC: 32, 36 1/2" Drive 12-Point Impact Socket

## C99-E114H2

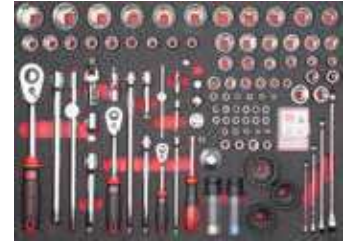
114 Pc 1/4"+3/8"+1/2" Drive 6-Point Socket Set **new**

CODE NO	PIECES
C99-E114H2	114
B17	4 PC: E6xE8, E10xE12, E14xE18, E20xE24 E-TORX Ring Wrenches
C02-H	12 PC: 4, 5, 5.5, 6, 7, 8, 9, 10, 11, 12, 13, 14 mm 1/4" Drive 6-Point Socket
C06	5 PC: E4, E5, E6, E7, E8 1/4" Drive E-TORX Sockets
C08S-S	3 PC: 4.0, 5.5, 6.5 mm 1/4" Drive Slotted Socket Bits
C08S-PH	2 PC: PH1, PH2 1/4" Drive Phillips Socket Bits
C08S-PZ	2 PC: PZ1, PZ2 1/4" Drive Pozidriv Socket Bits
C08S-H	5 PC: 3, 4, 5, 6, 8 mm 1/4" Drive Hexagon Socket Bits
C01-12	1/4" Drive Quick Release Reversible Ratchet
C01-20	1/4" Drive Spinner Handle (150 mm)
C01-40	1/4" Drive Sliding T-Handle (115 mm)
C01-70	2 PC: 50, 150 mm 1/4" Drive Extension Bar
C01-80	1/4" Drive Universal Joint
C01-92	1/4" Socket Adaptor- (F: 1/4" - M: 3/8")
C12-H	12 PC: 10, 11, 12, 13, 14, 15, 16, 17, 18, 19, 21, 22 mm 3/8" Drive 6-Point Sockets
C16	4 PC: E10, E11, E12, E14 3/8" Drive E-TORX Sockets
C11-12	3/8" Drive Quick Release Reversible Ratchet
C11-70	3 PC: 75, 150, 250 mm 3/8" Drive Extension Bar
C11-80	3/8" Drive Universal Joint
C11-91	3/8" Socket Adaptor- (F: 3/8" - M: 1/4")
C11-92S	3/8" Socket Adaptor- (F: 3/8" - M: 1/2")
C22-B	20 PC: 10, 11, 12, 13, 14, 15, 16, 17, 18, 19, 20, 21, 22, 23, 24, 26, 27, 28, 30, 32 mm 1/2" Drive 12-Point Sockets
C26	4 PC: E16, E18, E20, E24 1/2" Drive E-TORX Sockets
C64W-H	2 PC: 17, 19 mm 1/2" Drive DuraMAX Impact Wheel Nut Socket
C21-12	1/2" Drive Quick Release Reversible Ratchet
C21-40	1/2" Drive Sliding T-Handle (250 mm)
C21-70W	3 PC: 50, 125, 250 mm 1/2" Drive Wobble Extension Bars
C21-80	1/2" Drive Universal Joint
C21-91S	1/2" Drive Socket Adaptor (F:1/2"- M:3/8")
C21-92	1/2" Drive Socket Adaptor (F:1/2"- M:3/4")
C62-B	3 PC: 32, 34, 36 mm 1/2" Drive 12-Point Impact Sockets
C31-91	3/4" Drive Socket Adaptor (F:3/4"- M:1/2)
CB/800	5 PC: T5, T6, T7, T8, T9 TORX Bits
CB/800T	7 PC: T10, T15, T20, T25, T27, T30, T40 TORX Tamper Resistant Bits
BT/8001	1/4" Drive Bit Holder Socket (for 1/4" Bits)

# 01 Tool Containers and Assortments

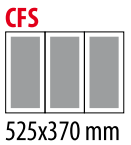

## C99-E77H2

77 Pc 1/4" + 1/2" Drive 6-Point Socket and Socket Bits Set **new**



CODE NO	PIECES
C99-E77H2	77
C02-H	12 PC: 4, 5, 5.5, 6, 7, 8, 9, 10, 11, 12, 13, 14 mm 1/4" Drive 6-Point Socket
C04-H	11 PC: 4, 5, 5.5, 6, 7, 8, 9, 10, 11, 12, 13 mm 1/4" Drive 6-Point Deep Sockets
C08S-S	3 PC: 4, 5, 5.5, 6.5 mm 1/4" Drive Slotted Socket Bits
C08S-PH	2 PC: PH1, PH2 1/4" Drive Phillips Socket Bits
C08S-PZ	2 PC: PZ1, PZ2 1/4" Drive Pozidriv Socket Bits
C08S-H	5 PC: 3, 4, 5, 6, 8 mm 1/4" Drive Hexagon Socket Bits
C01-12	1/4" Drive Quick Release Reversible Ratchet
C01-20	1/4" Drive Spinner Handle (150 mm)
C01-40	1/4" Drive Sliding T-Handle (115 mm)
C01-70	2 PC: 50, 150 mm 1/4" Drive Extension Bar
C01-80	1/4" Drive Universal Joint
C01-92	1/4" Socket Adaptor- (F: 1/4" - M: 3/8")
C22-H	17 PC: 10, 11, 12, 13, 14, 15, 16, 17, 18, 19, 20, 21, 22, 24, 27, 30, 32 mm 1/2" Drive 6-Point Sockets
C28S-H	8 PC: 5, 6, 7, 8, 10, 12, 14, 17 mm 1/2" Drive Hexagon Socket Bits
C64W-H	2 PC: 17, 19 mm 1/2" Drive DuraMAX Impact Wheel Nut Socket
C21-12	1/2" Drive Quick Release Reversible Ratchet
C21-40	1/2" Drive Sliding T-Handle (250 mm)
C21-70	2 PC: 125, 250 mm 1/2" Drive Extension Bars
C21-71W	50 mm 1/2" Drive Wobble Extension Bar
C21-80	1/2" Drive Universal Joint
C21-91S	1/2" Drive Socket Adaptor (F: 1/2" - M: 3/8")
C21-92	1/2" Drive Socket Adaptor (F: 1/2" - M: 3/4")

## C99-E79H2

79 Piece 3/8" Drive 6-Point Socket and TORX Tool Set **new**



CODE NO	PIECES
C99-E79H2	79
B17	4 PC: E6xE8, E10xE12, E14xE18, E20xE24 E-TORX Ring Wrenches
B19	10x11 mm Flare Nut Wrench
C06	5 PC: E4, E5, E6, E7, E8 1/4" Drive E-TORX Sockets
C12-H	15 PC: 7, 8, 9, 10, 11, 12, 13, 14, 15, 16, 17, 18, 19, 21, 22 mm 3/8" Drive 6-Point Sockets
C14-H	4 PC: 10, 11, 12, 13 mm 3/8" Drive 6-Point Deep Sockets
C12U-B	10 PC: 10, 11, 12, 13, 14, 15, 16, 17, 18, 19 mm 3/8" Drive 12-Point Jointed Sockets
C16	4 PC: E10, E11, E12, E14 3/8" Drive E-TORX Sockets
C18S-H	9 mm 3/8" Drive Hexagon Socket Bits
C18S-T	4 PC: T40, T45, T50, T55 3/8" Drive TORX Socket Bits
C11-12	3/8" Drive Quick Release Reversible Ratchet
C11-40	3/8" Drive Sliding T-Handle (200 mm)
C11-70	3 PC: 75, 150, 250 mm 3/8" Drive Extension Bar
C11-80	3/8" Drive Universal Joint
C11-91	3/8" Socket Adaptor- (F: 3/8" - M: 1/4")
C11-92S	3/8" Socket Adaptor- (F: 3/8" - M: 1/2")
C26	4 PC: E16, E18, E20, E24 1/2" Drive E-TORX Sockets
C28S-T	3 PC: T50, T55, T60 1/2" Drive TORX Socket Bits
CB/800	4 PC: T6, T7, T8, T9 TORX Bits
CB/800T	7 PC: T10, T15, T20, T25, T27, T30, T40 TORX Tamper Resistant Bits
BT/8001	1/4" Drive Bit Holder Socket (for 1/4" Bits)
CB/3000G	3 PC: (M6, M8, M10) x 30 mm H10 Drive XZN (Splines) Bits- Short
BT/8005	3/8" Drive Bit Holder Socket (for H10 Bits)

## C99A-E115BMR

115 Pc 1/4" + 3/8" Drive 12-Point Socket Set- SAE **new**

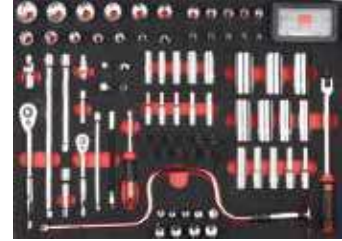

CODE NO	PIECES
C99A-E115BMR	115
C02A-B	10 PC: 3/16, 7/32, 1/4, 9/32, 5/16, 11/32, 3/8, 7/16, 1/2, 9/16 inch 1/4" Drive 12-Point Sockets - SAE
C02UA-B	9 PC: 7/32, 1/4, 9/32, 5/16, 11/32, 3/8, 7/16, 1/2, 9/16 inch 1/4" Drive 12-Point Joint Sockets - SAE
C04A-B	10 PC: 3/16, 7/32, 1/4, 9/32, 5/16, 11/32, 3/8, 7/16, 1/2, 9/16 inch 1/4" Drive 12-Point Deep Sockets - SAE
C08AS-H	11 PC: 1/16, 5/64, 3/32, 7/64, 1/8, 9/64, 5/32, 3/16, 7/32, 1/4, 5/16 inch 1/4" Drive Hexagon Socket Bits - SAE
C01-T90	1/4" Drive T90 Sealed Reversible Ratchet
C01-20	1/4" Drive Spinner Handle (150 mm)
C01-70	2 PC: 50, 150 mm 1/4" Drive Extension Bar
C01-75F	1/4" Drive Flexible Extension Bar- 150 mm
C01-80	1/4" Drive Universal Joint
C01-92	1/4" Socket Adaptor- (F: 1/4" - M: 3/8")
C12A-B	13 PC: 1/4, 5/16, 3/8, 7/16, 1/2, 9/16, 5/8, 11/16, 3/4, 13/16, 7/8, 15/16, 1 inch 3/8" Drive 12-Point Sockets - SAE
C14A-B	13 PC: 1/4, 5/16, 3/8, 7/16, 1/2, 9/16, 5/8, 11/16, 3/4, 13/16, 7/8, 15/16, 1 inch 3/8" Drive 12-Point Deep Sockets - SAE
C11-T90	3/8" Drive T90 Sealed Reversible Ratchet
C11-36MR	3/8" Drive Swivel Handle - 215 mm
C11-50MR	3/8" Drive Speeder Brace - Metal Palm Handle (420 mm)
C11-70	3 PC: 75, 150, 250 mm 3/8" Drive Extension Bar
C11-80	3/8" Drive Universal Joint
C11-91	3/8" Socket Adaptor- (F: 3/8" - M: 1/4")
CB/ST31	31 PC: Slotted/PH/PZ/TORX/Hex. Bits, BT/02 Bit Holder Reversible Bit Ratchet#2 - 1/4" x 90 mm
F26/BR2	1/4" Drive Bit Holder Socket (for 1/4" Bits)
BT/8001	3/8" Drive Bit Holder Socket (for 1/4" Bits)
BT/8003	3/8" Drive Bit Holder Socket (for 1/4" Bits)



## CF-E108

108 Piece Screwdriver and TORX Tool Set

new



CODE NO	PIECES
CF-E108	108
F10	4 PC: 3.0x75, 4.0x100, 5.5x125, 6.5x150 mm C-PLUS Slotted Screwdrivers
F14	2 PC: PH1x80, PH2x100 mm C-PLUS Phillips Screwdrivers
F13	5.5 x 25 mm C-PLUS Slotted Stubby Screwdriver
F16	PH2 x 25 mm C-PLUS Phillips Stubby Screwdriver
F26/BT	C-PLUS Bit Driver - 1/4" x 100 mm
CB/ST31	31 PC: Slotted/PH/PZ/TORX/Hex. Bits, BT/02 Bit Holder
F26/RDS	12-in-1: Stubby Ratchet Bit Driver Set
F26/BR2	Reversible Bit Ratchet#2 - 1/4" x 90 mm
6105CP	Voltage Tester (for 110 to 250V-VDE Approved)
G09-11	Car Electric Circuit Tester - 6/24 DC (V)
F18	7 PC: T10x80, T15x80, T20x100, T25x100, T27x115, T30x115, T40x130 mm C-PLUS TORX Screwdrivers
LT/900	9 PC: 1.5, 2, 2.5, 3, 4, 5, 6, 8, 10 mm Ball End Hexagon L Key Set (Long Arm)
LT/700L	8 PC: T9, T10, T15, T20, T25, T27, T30, T40 TORX L Key Set (Long Arm)
C06	6 PC: E4, E5, E6, E7, E8, E10 1/4" Drive E-TORX Sockets
C26	6 PC: E12, E14, E16, E18, E20, E24 1/2" Drive E-TORX Sockets
C285-T	9 PC: (T20, T25, T27, T30, T40, T45, T50, T55, T60) x 55 mm 1/2" Drive TORX Socket Bits - Short
C285-TL	4 PC: (T30, T40, T45, T50) x 100 mm 1/2" Drive TORX Socket Bits - Long
C285-XL	4 PC: (M6, M8, M10, M12) x 100 mm 1/2" Drive XZN Socket Bits - Long

## EF-E27

27 Piece Tool Set

new



CODE NO	PIECES
EF-E27	27
4100M	4 PC: 3.0x75, 4.0x100, 5.5x125, 6.5x150 mm TOREX Slotted Screwdrivers
4200M	2 PC: PH1x80, PH2x100 mm TOREX Phillips Screwdrivers
1300M	5 PC: (6, 7, 8, 10, 13)x125 mm TOREX Nut Drivers
LT/9	9 PC: 1.5, 2, 2.5, 3, 4, 5, 6, 8, 10 mm Hexagon L Key Set (Short Arm)
6105CP	Voltage Tester (for 110 to 250V-VDE Approved)
E01-41	180 mm Combination Pliers
E06-41	160 mm Diagonal Cutter
E15-41	160 mm Long Nose Pliers
E30-54	250 mm Water Pump Pliers (Box Joint)
L01-500	Machinist's Hammer - 500 gr
L25-200-2	Flat Chisel - 24x 200 mm

## F99-E81

81 Piece Screwdriver and T-Handle Key Set

new



CODE NO	PIECES
F99-E81	81
F10	4 PC: 3.0x75, 4.0x100, 5.5x125, 6.5x150 mm C-PLUS Slotted Screwdrivers
F14	2 PC: PH1x80, PH2x100 mm C-PLUS Phillips Screwdrivers
F13	5.5 x 25 mm C-PLUS Slotted Stubby Screwdriver
F16	PH2 x 25 mm C-PLUS Phillips Stubby Screwdriver
F20	5 PC: (6, 7, 8, 10, 13)x125 mm C-PLUS Nut Drivers
K10	6 PC: 2x100, 2.5x100, 3x100, 4x150, 5x150, 6x200 mm T-Handle Hexagon Key
LT/900	9 PC: 1.5, 2, 2.5, 3, 4, 5, 6, 8, 10 mm Ball End Hexagon L Key Set (Long Arm)
LT/700L	8 PC: T9, T10, T15, T20, T25, T27, T30, T40 TORX L Key Set (Long Arm)
F26/BT	C-PLUS Bit Driver - 1/4" x 100 mm
CB/ST31	31 PC: Slotted/PH/PZ/TORX/Hex. Bits, BT/02 Bit Holder
F26/RDS	12-in-1: Stubby Ratchet Bit Driver Set
6105CP	Voltage Tester (for 110 to 250V-VDE Approved)

## F99A-E80

80 Piece Screwdriver and L/T Key Set - SAE

new



CODE NO	PIECES
F99A-E80	80
F10	4 PC: 3.0x75, 4.0x100, 5.5x125, 6.5x150 mm C-PLUS Slotted Screwdrivers
F14	2 PC: PH1x80, PH2x100 mm C-PLUS Phillips Screwdrivers
F13	5.5 x 25 mm C-PLUS Slotted Stubby Screwdriver
F16	PH2 x 25 mm C-PLUS Phillips Stubby Screwdriver
F20A	3 PC: (1/4, 5/16, 3/8 inch)x125 mm C-PLUS Nut Drivers - SAE
K10A	7 PC: 5/64x100, 3/32x100, 1/8x100, 5/32x150, 3/16x150, 1/4x150, 5/16x200 mm T-Handle Hexagon Keys - SAE
LT/900AF	9 PC: 1/16, 5/64, 3/32, 1/8, 5/32, 3/16, 1/4, 5/16, 3/8 inch Ball End Hexagon L Key Set (Long Arm) - SAE
LT/700L	8 PC: T9, T10, T15, T20, T25, T27, T30, T40 TORX L Key Set (Long Arm)
F26/BT	C-PLUS Bit Driver - 1/4" x 100 mm
CB/ST31	31 PC: Slotted/PH/PZ/TORX/Hex. Bits, BT/02 Bit Holder
F26/RDS	12-in-1: Stubby Ratchet Bit Driver Set
6105CP	Voltage Tester (for 110 to 250V-VDE Approved)

## FLR-E36

36 Piece Tool Set

new



CODE NO	PIECES
FLR-E36	36
F20	4 PC: (7, 8, 10, 13)x125 mm C-PLUS Nut Drivers
J45CPM	C-Pro Utility Knife (Metal Body) - 18 mm
J45-R	10 PC: 18 mm Utility Knife Blade
L01-500	Machinist's Hammer - 500 gr
L12-40	Soft Face Hammer - Ø 40 mm
L12-R40	Spare Plastic Head - Ø 40 mm (Single)
L25-200-2	Flat Chisel - 24x 200 mm
L29-4	Centre Punch - Ø4 x 120 mm
L31	4 PC: Ø(3, 4, 5, 6) x 150 mm Parallel Pin Punch
N21-10	Brake Caliper Brush - 220 mm
N31-12	Trim Clip Removal Tool - 150 mm
P05-0519	Compact Tape Measure (5 M x 19 mm)
P15-030	Stainless Steel Rule - 30 cm
P54-20S	Feeler Gauge (Metric) - 20 Leaf (0,05 - 1,0 mm)
R11-PEN	Stylus LED Flashlight - 100 Lumen
R15-1000	Magnetic Pick-Up Tool (Cap.: 1000 gr)
R36-1	Straight Pick
R36-2	Angle Pick
R36-3	90° Pick
R36-4	Hook Pick
R37-25	Seal Scraper - 25 x 150 mm

## F99-E79

79 Piece Screwdriver and L/T Key Set

new



CODE NO	PIECES
F99-E79	79
F10	4 PC: 3.0x75, 4.0x100, 5.5x125, 6.5x150 mm C-PLUS Slotted Screwdrivers
F14	2 PC: PH1x80, PH2x100 mm C-PLUS Phillips Screwdrivers
F13	5.5 x 25 mm C-PLUS Slotted Stubby Screwdriver
F16	PH2 x 25 mm C-PLUS Phillips Stubby Screwdriver
F26/BT	C-PLUS Bit Driver - 1/4" x 100 mm
CB/ST31	31 PC: Slotted/PH/PZ/TORX/Hex. Bits, BT/02 Bit Holder
F26/RDS	12-in-1: Stubby Ratchet Bit Driver Set
F26/BR2	Reversible Bit Ratchet#2 - 1/4" x 90 mm
6105CP	Voltage Tester (for 110 to 250V-VDE Approved)
G09-11	Car Electric Circuit Tester - 6/24 DC (V)
F18	7 PC: T10x80, T15x80, T20x100, T25x100, T27x115, T30x115, T40x130 mm C-PLUS TORX Screwdrivers
LT/900	9 PC: 1.5, 2, 2.5, 3, 4, 5, 6, 8, 10 mm Ball End Hexagon L Key Set (Long Arm)
LT/700L	8 PC: T9, T10, T15, T20, T25, T27, T30, T40 TORX L Key Set (Long Arm)

# 01 Tool Containers and Assortments



## EF-E34

34 Piece Tool Set

new



CODE NO	PIECES
EF-E34	34
F10	2 PC: 5.5x100, 8.0x150 mm C-PLUS Slotted Screwdrivers
F14	3 PC: PH0x80, PH1x100, PH2x125 mm C-PLUS Phillips Screwdrivers
3100/TF2	PH2/6.0 x 175 mm Reversible Screwdriver
Z/12	PH1/PH2 x 100 mm Offset Phillips Screwdriver
Z/40	4.0/4.0 x 100 mm Offset Slotted Screwdriver
LT/900AF	9 PC: 1/16, 5/64, 3/32, 1/8, 5/32, 3/16, 1/4, 5/16, 3/8 inch Ball End Hexagon L Key Set (Long Arm)-SAE
K99-F2M	9 PC: 0.05, 1/16, 5/64, 3/32, 7/64, 1/8, 9/64, 5/32, 3/16 inch Foldup Hexagon Key Set (Metal Body)-SAE
E01-44	180 mm Combination Pliers
E06-44	160 mm Diagonal Cutter
E15-44	200 mm Long Nose Pliers
E16-44	160 mm Bent Long Nose Pliers
E30-54	250 mm Water Pump Pliers (Box Joint)
E80-230R	Wire Twisting Pliers (Reversible) - 230 mm
E50-2	2 PC: 140, 190 mm Grip Pliers (Curved Jaws)

## EF-E72

72 Piece Tool Set

new



CODE NO	PIECES
EF-E72	72
F10	4 PC: 3.0x75, 4.0x100, 5.5x125, 6.5x150 mm C-PLUS Slotted Screwdrivers
F14	2 PC: PH1x80, PH2x100 mm C-PLUS Phillips Screwdrivers
LT/900	9 PC: 1.5, 2, 2.5, 3, 4, 5, 6, 8, 10 mm Ball End Hexagon L Key Set (Long Arm)
CB/ST31	31 PC: Slotted/PH/PZ/TORX/Hex. Bits, BT/02 Bit Holder
6105CP	Voltage Tester (for 110 to 250V-VDE Approved)
E01-41	180 mm Combination Pliers
E06-41	160 mm Diagonal Cutter
E15-41	160 mm Long Nose Pliers
E30-54	250 mm Water Pump Pliers (Box Joint)
J45C	Compact Utility Knife - 18 mm
J45-R	10 PC: Utility Knife Blade - 18 mm
L01-500	Machinist's Hammer - 500 gr
L25-200-2	Flat Chisel - 24x 200 mm
L29-4	Centre Punch - Ø4 x 120 mm
L31	4 PC: Ø(3, 4, 5, 6) x 150 mm Parallel Pin Punch
P05-0519	Compact Tape Measure (5 M x 19 mm)
P15-030	Stainless Steel Rule - 30 cm
P54-205	Feeler Gauge (Metric) - 20 Leaf (0,05 - 1,0 mm)

## E99-E10

10 Piece Pliers Set

new



CODE NO	PIECES
E99-E10	10
E01-41	180 mm Combination Pliers
E06-41	160 mm Diagonal Cutter
E15-41	200 mm Long Nose Pliers
E16-41	200 mm Bent Long Nose Pliers
E30-54	250 mm Water Pump Pliers (Box Joint)
E50-2	240 mm Grip Pliers (Curved Jaws)
E65-44	180 mm External Circlip Pliers (Straight-with Spring)
E66-44	180 mm External Circlip Pliers (Bent-with Spiraling)
E67-44	180 mm Internal Circlip Pliers (Straight-without Spring)
E68-44	180 mm Internal Circlip Pliers (Bent-without Spring)

## EL-E28

28 Piece Tool Set

new



CODE NO	PIECES
EL-E28	28
E01-41	180 mm Combination Pliers
E06-41	160 mm Diagonal Cutter
E15-41	160 mm Long Nose Pliers
E30-54	250 mm Water Pump Pliers (Box Joint)
E50-2	240 mm Grip Pliers (Curved Jaws)
J45CPM	C-Pro Utility Knife (Metal Body) - 18 mm
J45-R	10 PC: 18 mm Utility Knife Blade
L01-500	Machinist's Hammer - 500 gr
L12-40	Soft Face Hammer - Ø 40 mm
L12-R40	Spare Plastic Head - Ø 40 mm (Single)
L25-200-2	Flat Chisel - 24 x 200 mm
L29-4	Centre Punch - Ø4 x 120 mm
L31	4 PC: Ø(3, 4, 5, 6) x 150 mm Parallel Pin Punch
P05-0519	Compact Tape Measure (5 M x 19 mm)
P15-030	Stainless Steel Rule - 30 cm
P54-205	Feeler Gauge (Metric) - 20 Leaf (0,05 - 1,0 mm)

## JL-E53

53 Piece Tool Set

new



CODE NO	PIECES
JL-E53	53
J55-108H	Hand File (Bastard) - 20 x 200 mm
J56-108H	Half-Round File (Bastard) - 20 x 200 mm
J57-108H	Round File (Bastard) - Ø7.5 x 200 mm
J58-108H	Square File (Bastard) - 8 x 200 mm
J59-108H	Three Square File (Bastard) - 15 x 200 mm
J75-R06	6 PC: Needle File Set
J45CPM	C-Pro Utility Knife (Metal Body) - 18 mm
J45-R	10 PC: Utility Knife Blade - 18 mm
L01-500	Machinist's Hammer - 500 gr
L12-40	Soft Face Hammer - Ø 40 mm
L12-R40	Spare Plastic Head - Ø 40 mm (Single)
L25-200-2	Flat Chisel - 24x 200 mm
L29-4	Centre Punch - Ø4 x 120 mm
L31	4 PC: Ø(3, 4, 5, 6) x 150 mm Parallel Pin Punch
P05-0519	Compact Tape Measure (5 M x 19 mm)
P15-030	Stainless Steel Rule - 30 cm
P54-205	Feeler Gauge (Metric) - 20 Leaf (0,05 - 1,0 mm)
R21-P19	19 PC: 1, 1.5, 2, 2.5, 3, 3.5, 4, 4.5, 5, 5.5, 6, 6.5, 7, 7.5, 8, 8.5, 9, 9.5, 10 mm HSS Drill Bit Set

## LPR-E17

17 Piece Tool Set

new



CODE NO	PIECES
LPR-E17	17
L02-16	Ball Pein Hammer - 16 Oz/450 gr
L12-40	Soft Face Hammer - Ø 40 mm
L12-R40	Spare Plastic Head - Ø 40 mm (Single)
L29	3 PC: Ø3x110, Ø4x120, Ø5x150 mm Centre Punch
L31	2 PC: Ø(2, 5)x150 mm Parallel Pin Punch
P05A	Compact Tape Measure (Inch/Metric) 5M-16 FT x 19 mm
P15-030	Stainless Steel Rule - 30 cm
P45A	Vernier Caliper - 150 mm
R.P6	Lumax PRO 2AA Focus Flashlight
R15-0500	Magnetic Pick-Up Tool (Cap.: 500 gr)
R16-700	Magnetic Pick-Up and Claw Tool (Cap.: 500 gr)
R20R	Telescoping Inspection Mirror (Round) - Ø 50 - 25/90cm
R35DE	Engineer's Double End Scriber - 235 mm
J47SPQ	Foldable Trimming Knife (Trapezoid Blade) - 19 mm



525x370 mm

**E55-E07**

7 Piece Clamp Grip Pliers Set

**new**

CODE NO	PIECES
E55-E07	7

E55-2	<b>2 PC:</b> 2x280 mm Clamp Grip Pliers (C Jaw)
E55P-2	<b>3 PC:</b> 2x180, 300 mm Clamp Grip Pliers (C Jaw - Swivel Tip)
L25-250G-2	Flat Chisel (with Hand Guard) - 28x250 mm
R40-4	Steel Wire Brush (4 Row) - 275 mm

**ENJ-E21**

21 Piece Tool Set

**new**

CODE NO	PIECES
ENJ-E21	21

K20	<b>6 PC:</b> (6, 7, 8, 10, 11, 13)x125 mm T-Handle Nut Driver
E36-54	225 mm Concretors' Nippers (PVC Sleeves)
E50-2	240 mm Grip Pliers (Curved Jaws)
L01-300	Machinist's Hammer - 300 gr
L25-250G-2	28x250 mm Flat Chisel (with Hand Guard)
R40-4	275 mm Steel Wire Brush (4 Row)
R35DE	Engineer's Double End Scriber
N31-1105	<b>5 PC:</b> Trim and Upholstery Removal Set
N31-12	150 mm Trim Clip Removal Tool
J04-250L	250 mm Aviation Tin Snips (Left Cut)
J04-250R	250 mm Aviation Tin Snips (Right Cut)
J81-200	10x200 mm Triangular Scraper

**EJ-E07**

7 Piece Tool Set

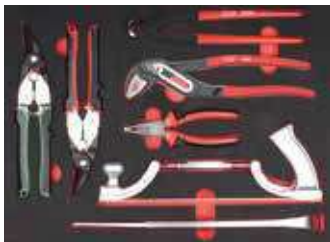
**new**

CODE NO	PIECES
EJ-E07	7

E01-41	180 mm Combination Pliers
E30-54	300 mm Water Pump Pliers (Box Joint)
E36-54	280 mm Concretors' Nippers (PVC Sleeves)
J04-250L	250 mm Aviation Tin Snips (Left Cut)
J04-250R	250 mm Aviation Tin Snips (Right Cut)
N33-04	370 mm Bodywork File Holder (Including 9 TPI File)
L20-0401	400 mm Pry Bar (Flat)

**E50-E16**

16 Piece Grip Pliers Set

**new**

CODE NO	PIECES
E50-E16	16

E30-54	250 mm Water Pump Pliers (Box Joint)
E50-2	<b>3 PC:</b> 140, 190, 240 mm Grip Pliers (Curved Jaws)
E50L-2	<b>2 PC:</b> 170, 230 mm Long Nose Grip Pliers
E51-2	<b>2 PC:</b> 190, 240 mm Grip Pliers (Straight Jaws)
E52-2	240 mm Grip Pliers (Prism Jaws)
E52S-2	240 mm Grip Pliers (Multi-Purpose Jaws)
E56-J1	210 mm Axial Grip Pliers - J Tip
E56-J2	235 mm Axial Grip Pliers - JJ Tip
E56-L1	195 mm Axial Grip Pliers - L Tip
E56-L2	220 mm Axial Grip Pliers - LL Tip
E56-W1	195 mm Axial Grip Pliers - W Tip
J55-112H	Hand File (Bastard) - 30 x 300 mm

**N30-E12**

12 Piece Bodywork Tool Set

**new**

CODE NO	PIECES
N30-E12	12

N33-04	370 mm Bodywork File Holder (Including 9 TPI File)
N33-04R1D	350 mm Car Body File Blade (Diagonal Cut) - 9 TPI
N33-04R1C	350 mm Car Body File Blade (Curved Cut) - 9 TPI
J55-H	<b>3 PC:</b> 300 mm Hand Files (Bastard, Second, Smooth)
CF.AD002	Wedge Dolly (Flat)
CF.AD003	Toe Dolly
CF.AD004	Double End Dolly (Convex and Flat Head)
CF.AD007	Anvil Dolly
CF.AD008	Heel Dolly
CF.AD009	Wenge Dolly (Convex)

**N30-E05**

5 Piece Bodywork Tool Set

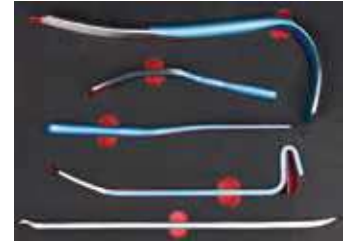
**new**

CODE NO	PIECES
N30-E05	5

N33-03DS	Double Ended Spoon (Angled and Flat Ends)
N33-03SLC	General Purpose Spoon (Chequered Face)
N33-03SS	General Purpose Spoon - Short Form
N33-03BI	Bending Iron
N23-0750	Tyre Lever - (500 mm : 20°)

**N30-E09**

9 Piece Bodywork Tool Set

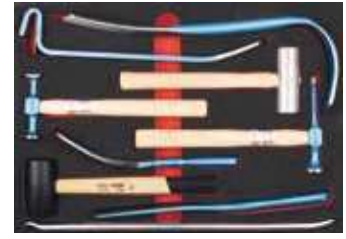
**new**

CODE NO	PIECES
N30-E09	9

N33-03DS	Double Ended Spoon (Angled and Flat Ends)
N33-03SLC	General Purpose Spoon (Chequered Face)
N33-03SS	General Purpose Spoon - Short Form
N33-03BI	Bending Iron
N33-01BMC2	Bumping Hammer (Milled Round / Flat Square Head)
N33-01BPF	Bumping Hammer (Flat Round / Ball Pein)
L16-40	Rubber Mallet - Ø60 mm
L17-40	Aluminium Hammer - Ø40 mm
N23-0750	Tyre Lever - (500 mm : 20°)

**N30-E10**

10 Piece Bodywork Tool Set

**new**

CODE NO	PIECES
N30-E10	10

N33-01BMC2	Bumping Hammer (Milled Round / Flat Square Head)
N33-01BPF	Bumping Hammer (Flat Round / Ball Pein)
L17-40	Aluminium Hammer - Ø40 mm
L12-30	Soft Face Hammer - Ø30 mm
L12-R30	Spare Plastic Heads (for L12-30) - Single
L12DB-40	Dead Blow Hammer - Ø40 mm
L01-300	Machinist's Hammer - 300 gr
CF.AD003	Toe Dolly
CF.AD007	Anvil Dolly
CF.AD001	Wedge Dolly (Curved)

# 01 Tool Containers and Assortments

## B01-E16 16 Piece Combination Wrench Set

new  
content



CODE NO	PIECES
B01-E16	16
B01	16 PC: 6, 7, 8, 9, 10, 11, 12, 13, 14, 15, 16, 17, 18, 19, 22, 24 mm Combination Wrenches

## B01-E21 21 Piece Combination Wrench and Hex Key Set



CODE NO	PIECES
B01-E21	21
B01	12 PC: 6, 7, 8, 9, 10, 11, 12, 13, 14, 17, 19, 22 mm Combination Wrenches
LT/9	9 PC: 1.5, 2, 2.5, 3, 4, 5, 6, 8, 10 mm Hexagon L Key Set (Short Arm)

## B01-E04 4 Piece Combination Wrench Set



CODE NO	PIECES
B01-E04	4
B01	4 PC: 24, 27, 30, 32 mm Combination Wrenches

## B05-E12 12 Piece C-GEAR Ratcheting Combination Wrench Set (Straight)



CODE NO	PIECES
B05-E12	12
B05	8 PC: 8, 10, 11, 12, 13, 14, 17, 19 mm C-GEAR Ratcheting Combination Wrenches (Straight)
B05-S	3 PC: 1/4"- 10 mm, 3/8"- 13 mm, 1/2"- 19 mm C-GEAR Socket Adaptors
B05-14B	1/4"- 10 mm C-GEAR Bit Adaptor

## B06-E12 12 Piece C-GEAR Ratcheting Combination Wrench Set (Flex Head)



CODE NO	PIECES
B06-E12	12
B06	8 PC: 8, 10, 11, 12, 13, 14, 17, 19 mm C-GEAR Ratcheting Combination Wrenches (Flex Head)
B05-S	3 PC: 1/4"- 10 mm, 3/8"- 13 mm, 1/2"- 19 mm C-GEAR Socket Adaptors
B05-14B	1/4"- 10 mm C-GEAR Bit Adaptor

## B09-E08 8 Piece Double Open End Wrench Set



CODE NO	PIECES
B09-E08	8
B09	8 PC: 6x7, 8x9, 10x11, 12x13, 14x15, 16x17, 18x19, 20x22 mm Double Open End Wrenches

## B09-E12 12 Piece Double Open End Wrench Set



CODE NO	PIECES
B09-E12	12
B09	12 PC: 6x7, 8x9, 10x11, 12x13, 14x15, 16x17, 18x19, 20x22, 21x23, 24x26, 25x28, 30x32 mm Double Open End Wrenches

## B14-E08 8 Piece Double Ring End Wrench Set



CODE NO	PIECES
B14-E08	8
B14	8 PC: 6x7, 8x9, 10x11, 12x13, 14x15, 16x17, 18x19, 20x22 mm Double Ring End Wrenches

## B17-E18 18 Piece E-TORX Ring Wrench and Socket Set

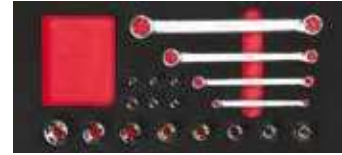

CODE NO	PIECES
B17-E18	18
B17	4 PC: E06xE08, E10xE12, E14xE18, E20xE24 E-TORX Double End Wrenches
C06	6 PC: E4, E5, E6, E7, E8, E10 1/4" Drive E-TORX Sockets
C26	8 PC: E10, E12, E14, E16, E18, E20, E22, E24 1/2" Drive E-TORX Sockets

## B28-E08 8 Piece Double Ended Offset Socket Wrench Set



CODE NO	PIECES
B28-E08	8
B28	8 PC: 8, 10, 11, 12, 13, 14, 17, 19 mm Double Ended Offset Socket Wrenches

## K99-10-E06 6 Piece T-Handle Key Set



CODE NO	PIECES
K99-10-E06	6
K10	6 PC: 2, 2.5, 3, 4, 5, 6 mm T-Handle Hexagon Keys

## K99-10-E15 15 Piece T-Handle and Ballpoint L Hex Key Set



CODE NO	PIECES
K99-10-E15	15
K10	6 PC: 2, 2.5, 3, 4, 5, 6 mm T-Handle Hexagon Keys
LT/900	9 PC: 1.5, 2, 2.5, 3, 4, 5, 6, 8, 10 mm Ball End Hexagon L Key Set (Long Arm)

**K99-12-E14**

14 Piece T-Handle and L TORX Key Set

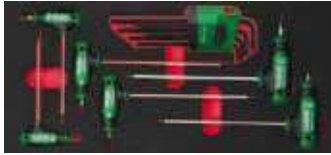

CODE NO	PIECES
K99-12-E14	14
K12	6 PC: T10, T15, T20, T25, T30, T40 T-Handle TORX Keys
LT/700L	8 PC: T9, T10, T15, T20, T25, T27, T30, T40 TORX L Key Set (Long Arm)

**C00-E26H2**

26 Piece 1/4" Drive Socket and Hex Key Set



CODE NO	PIECES
C00-E26H2	26
C02-H	12 PC: 4, 5, 5.5, 6, 7, 8, 9, 10, 11, 12, 13, 14 mm 1/4" Drive 6-Point Socket
C01-12	1/4" Drive Quick Release Reversible Ratchet
C01-40	1/4" Drive Sliding T-Handle (115 mm)
C01-70	2 PC: 50, 150 mm 1/4" Drive Extension Bar
C01-80	1/4" Drive Universal Joint
LT/9	9 PC: 1.5, 2, 2.5, 3, 4, 5, 6, 8, 10 mm Hexagon L Key Set (Short Arm)

**C00-E52H2**

52 Piece 1/4" Drive Socket and Hex Key Set



CODE NO	PIECES
C00-E52H2	52
C02-H	12 PC: 4, 5, 5.5, 6, 7, 8, 9, 10, 11, 12, 13, 14 mm 1/4" Drive 6-Point Sockets
C04-H	10 PC: 5, 5.5, 6, 7, 8, 9, 10, 11, 12, 13 mm 1/4" Drive 6-Point Deep Socket
C08S-T	7 PC: T10, T15, T20, T25, T27, T30, T40 1/4" Drive TORX Socket Bits
C08S-H	5 PC: 3, 4, 5, 6, 8 mm 1/4" Drive Hexagon Socket Bits
C08S-S	5.5 mm 1/4" Drive Slotted Socket Bits
C08S-PH	2 PC: PH1, PH2 1/4" Drive Phillips Socket Bits
C01-12	1/4" Drive Quick Release Reversible Ratchet
C01-20	1/4" Drive Spinner Handle (150 mm)
C01-40	1/4" Drive Sliding T-Handle (115 mm)
C01-70	2 PC: 50, 150 mm 1/4" Drive Extension Bar
C01-80	1/4" Drive Universal Joint
LT/9	9 PC: 1.5, 2, 2.5, 3, 4, 5, 6, 8, 10 mm Hexagon L Key Set (Short Arm)

**C00A-E15BT**

15 Piece 1/4" Drive Socket Set - SAE

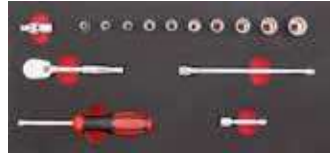

CODE NO	PIECES
C00A-E15BT	15
C02A-B	10 PC: 3/16, 7/32, 1/4, 9/32, 5/16, 11/32, 3/8, 7/16, 1/2, 9/16 inch 1/4" Drive 12-Point Sockets - SAE
C01-T90	1/4" Sealed Reversible Ratchet (Metal Handle)
C01-20	1/4" Drive Spinner Handle (150 mm)
C01-70	2 PC: 50, 150 mm 1/4" Drive Extension Bar
C01-80	1/4" Drive Universal Joint

**C00A-E25BT**

25 Piece 1/4" Drive Socket Set - SAE

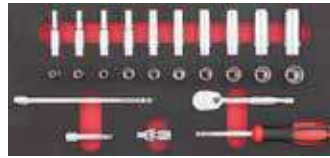

CODE NO	PIECES
C00A-E25BT	25
C02A-B	10 PC: 3/16, 7/32, 1/4, 9/32, 5/16, 11/32, 3/8, 7/16, 1/2, 9/16 inch 1/4" Drive 12-Point Sockets - SAE
C04A-B	10 PC: 3/16, 7/32, 1/4, 9/32, 5/16, 11/32, 3/8, 7/16, 1/2, 9/16 inch 1/4" Drive 12-Point Deep Sockets - SAE
C01-T90	1/4" Sealed Reversible Ratchet (Metal Handle)
C01-20	1/4" Drive Spinner Handle (150 mm)
C01-70	2 PC: 50, 150 mm 1/4" Drive Extension Bar
C01-80	1/4" Drive Universal Joint

**C00A-E39BT**

39 Piece 1/4" Drive Socket Set - SAE

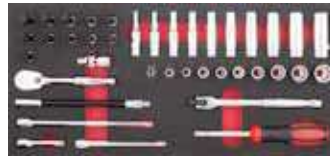

CODE NO	PIECES
C00A-E39BT	39
C02A-B	10 PC: 3/16, 7/32, 1/4, 9/32, 5/16, 11/32, 3/8, 7/16, 1/2, 9/16 inch 1/4" Drive 12-Point Sockets - SAE
C04A-B	10 PC: 3/16, 7/32, 1/4, 9/32, 5/16, 11/32, 3/8, 7/16, 1/2, 9/16 inch 1/4" Drive 12-Point Deep Sockets - SAE
C08AS-H	11 PC: 1/16, 5/64, 3/32, 7/64, 1/8, 9/64, 5/32, 3/16, 7/32, 1/4, 5/16 inch 1/4" Drive Hexagon Socket Bits
C01-T90	1/4" Sealed Reversible Ratchet (Metal Handle)
C01-20	1/4" Drive Spinner Handle (150 mm)
C01-70	3 PC: 50, 100, 150 mm 1/4" Drive Extension Bar
C01-75F	1/4" Drive Flexible Extension Bar
C01-35MR	1/4" Drive Swivel Handle (Metal Handle)
C01-80	1/4" Drive Universal Joint

**C00C-E45BHT**

45 Piece 1/4" Drive Socket Set - Metric / SAE



CODE NO	PIECES
C00C-E45BHT	45
C02-H	10 PC: 5.5, 6, 7, 8, 9, 10, 11, 12, 13, 14 mm 1/4" Drive 6-Point Socket
C04-H	10 PC: 5.5, 6, 7, 8, 9, 10, 11, 12, 13, 14 mm 1/4" Drive 6-Point Deep Socket
C02A-B	10 PC: 3/16, 7/32, 1/4, 9/32, 5/16, 11/32, 3/8, 7/16, 1/2, 9/16 inch 1/4" Drive 12-Point Sockets - SAE
C04A-B	10 PC: 3/16, 7/32, 1/4, 9/32, 5/16, 11/32, 3/8, 7/16, 1/2, 9/16 inch 1/4" Drive 12-Point Deep Sockets - SAE
C01-T90	1/4" Sealed Reversible Ratchet (Metal Handle)
C01-20	1/4" Drive Spinner Handle (150 mm)
C01-70	2 PC: 50, 150 mm 1/4" Drive Extension Bar
C01-80	1/4" Drive Universal Joint

**C10-E18H2**

18 Piece 3/8" Drive Socket Set



CODE NO	PIECES
C10-E18H2	18
C12-H	13 PC: 8, 10, 11, 12, 13, 14, 15, 16, 17, 18, 19, 21, 22 mm 3/8" Drive 6-Point Sockets
C11-12	3/8" Drive Quick Release Reversible Ratchet
C11-40	3/8" Drive Sliding T-Handle (200 mm)
C11-70	2 PC: 75, 150 mm 3/8" Drive Extension Bar
C11-80	3/8" Drive Universal Joint

**C10A-E17BT**

17 Piece 3/8" Drive Socket Set - SAE



CODE NO	PIECES
C10A-E17BT	17
C12A-B	13 PC: 1/4, 5/16, 3/8, 7/16, 1/2, 9/16, 5/8, 11/16, 3/4, 13/16, 7/8, 15/16, 1 inch 3/8" Drive 12-Point Sockets - SAE
C11-T90	3/8" Sealed Reversible Ratchet (Metal Handle)
C11-70	2 PC: 75, 150 mm 3/8" Drive Extension Bar
C11-80	3/8" Drive Universal Joint

# 01 Tool Containers and Assortments



## C10A-E30BT

30 Piece 3/8" Drive Socket Set - SAE

**new**



CODE NO	PIECES
C10A-E30BT	30

C12A-B **13 PC:** 1/4, 5/16, 3/8, 7/16, 1/2, 9/16, 5/8, 11/16, 3/4, 13/16, 7/8, 15/16, 1 inch 3/8" Drive 12-Point Sockets - SAE

C14A-B **13 PC:** 1/4, 5/16, 3/8, 7/16, 1/2, 9/16, 5/8, 11/16, 3/4, 13/16, 7/8, 15/16, 1 inch 3/8" Drive 12-Point Deep Sockets - SAE

C11-T90 3/8" Sealed Reversible Ratchet (Metal Handle)

C11-70 **2 PC:** 75, 150 mm 3/8" Drive Extension Bar

C11-80 3/8" Drive Universal Joint

## C24-E13H

13 Piece 1/2" Drive Deep Socket Set

**new**

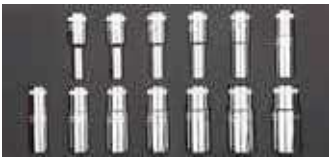

CODE NO	PIECES
C24-E13H	13

C24-H **13 PC:** 10, 11, 12, 13, 14, 15, 16, 17, 18, 19, 21, 22, 24 mm 1/2" Drive 6-Point Deep Sockets

## C24-E17H

17 Piece 1/2" Drive Deep Socket Set

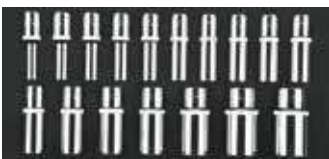

CODE NO	PIECES
C24-E17H	17

C24-H **17 PC:** 8, 10, 11, 12, 13, 14, 15, 16, 17, 18, 19, 21, 22, 24, 27, 30, 32 mm 1/2" Drive 6-Point Deep Sockets

## C28S-E14H

14 Piece 1/2" Drive Hexagon Socket Bit Set



CODE NO	PIECES
C28S-E14H	14

C28S-H **9 PC:** (5, 6, 7, 8, 10, 12, 14, 17, 19) x 30 mm 1/2" Drive Hexagon Socket Bits - Short

C28S-HL **5 PC:** (5, 6, 8, 10, 12) x 100 mm 1/2" Drive Hexagon Socket Bits - Long

## C28S-E29

29 Piece 1/2" Drive TORX/Hex/XZN Socket Bits Set

**new**  
content

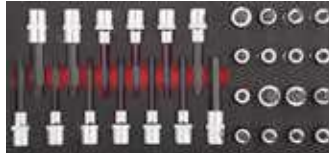

CODE NO	PIECES
C28S-E29	29

C28S-T **9 PC:** (T20, T25, T27, T30, T40, T45, T50, T55, T60) x 55 mm 1/2" Drive TORX Socket Bits - Short

C28S-TL **4 PC:** (T30, T40, T45, T50) x 100 mm 1/2" Drive TORX Socket Bits - Long

C28S-H **7 PC:** (5, 6, 7, 8, 10, 12, 14) x 55 mm 1/2" Drive Hexagon Socket Bits - Short

C28S-HL **4 PC:** (6, 8, 10, 12 mm) x 100 mm 1/2" Drive Hexagon Socket Bits - Long

C28S-XL **5 PC:** (M6, M8, M10, M12, M14) x 100 mm 1/2" Drive XZN Socket Bits - Long

## C20-E23H2

23 Piece 1/2" Drive Socket Set



CODE NO	PIECES
C20-E23H2	23

C20-H **18 PC:** 8, 10, 11, 12, 13, 14, 15, 16, 17, 18, 19, 20, 21, 22, 24, 27, 30, 32 mm 1/2" Drive 6-Point Sockets

C21-12 1/2" Drive Quick Release Reversible Ratchet

C21-40 1/2" Drive Sliding T-Handle (250 mm)

C21-70 **2 PC:** 125, 250 mm 1/2" Drive Extension Bar

C21-80 1/2" Drive Universal Joint

## C20A-E20BT

20 Piece 1/2" Drive Socket Set - SAE

**new**



CODE NO	PIECES
C20A-E20BT	20

C22A-B **15 PC:** 3/8, 7/16, 1/2, 9/16, 5/8, 11/16, 3/4, 13/16, 7/8, 15/16, 1, 1-1/16, 1-1/8, 1-3/16, 1-1/4 inch 1/2" Drive 12-Point Sockets - SAE

C21-T90 1/2" Sealed Reversible Ratchet (Metal Handle)

C21-40 1/2" Drive Sliding T-Handle (250 mm)

C21-70 **2 PC:** 125, 250 mm 1/2" Drive Extension Bar

C21-80 1/2" Drive Universal Joint

## C28-SSE40

40 Piece H10 TORX/Hex/XZN Bit Set

**new**  
content



CODE NO	PIECES
C28-SSE40	40

BT/8005 3/8" Drive Bit Holder Socket (10 mm)

BT/8008 1/2" Drive Bit Holder Socket (10 mm)

CB/1000 **7 PC:** (T20, T25, T30, T40, T45, T50, T55) x 30 mm H10 Drive Torx Bits - Short

CB/1100 **7 PC:** (T20, T25, T30, T40, T45, T50, T55) x 75 mm H10 Drive Torx Bits - Long

CB/2000 **7 PC:** (4, 5, 6, 7, 8, 10, 12) x 30 mm H10 Drive Hexagon Bits - Short

CB/2100 **7 PC:** (4, 5, 6, 7, 8, 10, 12) x 75 mm H10 Drive Hexagon Bits - Long

CB/3000 **5 PC:** (M5, M6, M8, M10, M12) x 30 mm H10 Drive XZN (Spline) Bits - Short

CB/3100 **5 PC:** (M5, M6, M8, M10, M12) x 75 mm H10 Drive XZN (Spline) Bits - Long

## C62-E18

18 Piece 1/2" Drive Impact Socket Set



CODE NO	PIECES
C62-E18	18

C62-H **16 PC:** 10, 11, 12, 13, 14, 15, 16, 17, 18, 19, 21, 22, 24, 27, 30, 32 mm 1/2" Drive 6-Point Impact Sockets

C61-74 1/2" Drive Impact Extension Bar (125 mm)

C61-92 1/2" Drive Impact Socket Adaptor - F1/2" M3/4"

## C64-E10

10 Piece 1/2" Drive Impact Deep Socket Set



CODE NO	PIECES
C64-E10	10

C64-H **10 PC:** 10, 11, 12, 13, 14, 17, 19, 21, 22, 24 mm 1/2" Drive 6-Point Impact Deep Sockets

**F99-E701**

7 Piece C-PLUS Slotted/PH Screwdriver Set

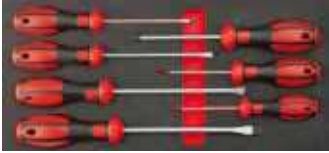

CODE NO	PIECES
F99-E701	7
F10	5 PC: 3x75, 4x100, 5.5x125, 6.5x150, 8x150 mm C-PLUS Slotted Screwdrivers
F14	2 PC: PH1x80, PH2x100 mm C-PLUS Phillips Screwdrivers

**4000M-E701**

7 Piece TOREX Slotted/PH Screwdriver Set

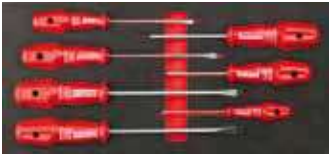

CODE NO	PIECES
4000M-E701	7
4100M	5 PC: 3x75, 4x100, 5.5x125, 6.5x150, 8x150 mm TOREX Slotted Screwdrivers
4200M	2 PC: PH1x80, PH2x100 mm TOREX Phillips Screwdrivers

**F99-E3901**

39 Piece C-PLUS Slotted/PH Screwdriver and Bit Set



CODE NO	PIECES
F99-E3901	39
F10	4 PC: 3x75, 4x100, 5.5x125, 6.5x150 mm C-PLUS Slotted Screwdrivers
F14	2 PC: PH1x80, PH2x100 mm C-PLUS Phillips Screwdrivers
F26/BT	C-PLUS Bit Driver - 1/4"x100 mm
CB/ST31	31 PC: Slotted/PH/PZ/TORX/Hex. Bits, BT/02 Bit Holder
6105CP	Voltage Tester (for 110 to 250V-VDE Approved)

**F99-E3902**

39 Piece C-PLUS Slotted/PZ Screwdriver and Bit Set



CODE NO	PIECES
F99-E3902	39
F10	4 PC: 3x75, 4x100, 5.5x125, 6.5x150 mm C-PLUS Slotted Screwdrivers
F17	2 PC: PZ1x80, PZ2x100 mm C-PLUS Pozidriv Screwdrivers
F26/BT	C-PLUS Bit Driver - 1/4"x100 mm
CB/ST31	31 PC: Slotted/PH/PZ/TORX/Hex. Bits, BT/02 Bit Holder
6105CP	Voltage Tester (for 110 to 250V-VDE Approved)

**4000M-E1901**

19 Piece TOREX Slotted/PH Screwdriver and Bit Set



CODE NO	PIECES
4000M-E1901	19
4100M	4 PC: 3x75, 4x100, 5.5x125, 6.5x150 mm TOREX Slotted Screwdrivers
4200M	2 PC: PH1x80, PH2x100 mm TOREX Phillips Screwdrivers
3100/BT1	Bit Driver with Magazine - 1/4"x100 mm
CB/ST111	11 PC: Bit Set - Slotted/PH/PZ Bits, BT/02 Bit Holder
6105CP	Voltage Tester (for 110 to 250V-VDE Approved)

**F99-E0705**

7 Piece C-PLUS TORX Screwdriver Set

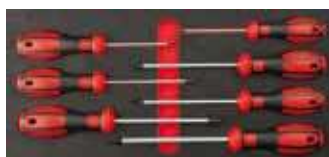

CODE NO	PIECES
F99-E0705	7
F18	7 PC: T10x80, T15x80, T20x100, T25x100, T27x115, T30x115, T40x130 mm C-PLUS TORX Screwdrivers

**F99-E0706**

7 Piece C-PLUS TORX Tamper Proof Screwdriver Set

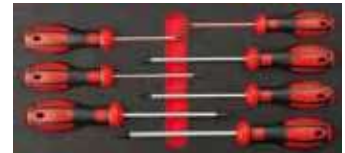

CODE NO	PIECES
F99-E0706	7
F19	7 PC: T10x80, T15x80, T20x100, T25x100, T27x115, T30x115, T40x130 mm C-PLUS TORX Tamper Proof Screwdrivers

**4400M-E701**

7 Piece TOREX TORX Screwdriver Set



CODE NO	PIECES
4400M-E701	7
4400M	7 PC: T10x80, T15x80, T20x100, T25x100, T27x115, T30x115, T40x130 mm TOREX TORX Screwdrivers

**F99-E0507**

5 Piece C-PLUS Nut Driver Set



CODE NO	PIECES
F99-E0507	5
F20	5 PC: (6, 7, 8, 10, 13)x125 mm C-PLUS Nut Drivers

**1300M-E501**

5 Piece TOREX Nut Driver Set



CODE NO	PIECES
1300M-E501	5
1300M	5 PC: (6, 7, 8, 10, 13)x125 mm TOREX Nut Drivers

# 01 Tool Containers and Assortments



## E99-41-E0103

3 Piece DuoTech Pliers Set (Polished Finish)



CODE NO	PIECES
E99-41-E0103	3
E01-41	180 mm Combination Pliers
E06-41	160 mm Diagonal Cutter
E15-41	160 mm Long Nose Pliers

## E99-E0502

2 Piece Water Pump and Grip Pliers Set



CODE NO	PIECES
E99-E0502	2
E30-54	250 mm Water Pump Pliers (Box Joint)
E50-2	240 mm Grip Pliers (Curved Jaws)

## E99-E0503

3 Piece Pliers and Adjustable Wrench Set

**new**  
content



CODE NO	PIECES
E99-E0503	3
E30-54	250 mm Water Pump Pliers (Box Joint)
E50-2	240 mm Grip Pliers (Curved Jaws)
B21-B	200 mm Adjustable Wrench (Phosphated)

## E99-44-E0404

4 Piece Cirdip Pliers Set



CODE NO	PIECES
E99-44-E0404	4
E65-44	180 mm External Cirdip Pliers (Straight-with Spring)
E66-44	180 mm External Cirdip Pliers (Bent-with Spring)
E67-44	180 mm Internal Cirdip Pliers (Straight-without Spring)
E68-44	180 mm Internal Cirdip Pliers (Bent-without Spring)

## G99-E701

7 Piece C-PLUS 1000V Insulated Slotted/PH Screwdriver Set (VDE Approved)

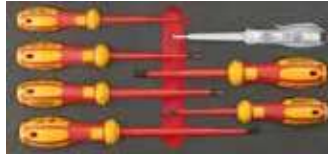

CODE NO	PIECES
G99-E701	7
G01	4 PC: 3x100, 4x100, 5.5x125, 6.5x150 mm C-PLUS VDE 1000V Insulated Slotted Screwdrivers
G02	2 PC: PH1x80, PH2x100 mm C-PLUS VDE 1000V Insulated Phillips Screwdrivers
G105CP	1 Voltage Tester (for 110 to 250V-VDE Approved)

## G99-18-E0103

3 Piece DuoTech 1000V Insulated Pliers Set (VDE Approved)



CODE NO	PIECES
G99-18-E0103	3
G10-18	180 mm VDE 1000V Insulated Combination Pliers
G12-18	160 mm VDE 1000V Insulated Diagonal Cutter
G15-18	160 mm VDE 1000V Insulated Long Nose Pliers

## H99-E06

6 Piece C-TRONIC Precision Pliers and Tweezer Set

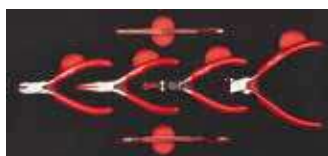

CODE NO	PIECES
H99-E06	6
H305-1105B	Electronics Diagonal Cutter (Small Bevel) -110 mm
H315-1205B	Electronics End Cutter-120 mm
H335-120	Electronics Short Needle Nose Pliers (Toothed Gripping Surface)- 120 mm
H37-120	Electronics Flat Nose Pliers- 120 mm
H43-120-SA	Blunt Shape Tweezers-Serrated (Straight)- 120 mm
H43-125B-SA	Blunt Shape Tweezers- Serrated (Bent)- 125 mm

## H99-31-E0310

10 Piece C-TRONIC Precision Pliers and Screwdriver Set

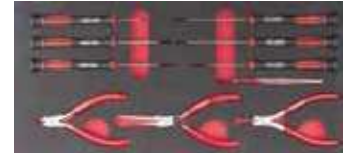

CODE NO	PIECES
H99-31-E0310	10
H305-1105B	Electronics Diagonal Cutters (Small Bevel)-110 mm
H335-120	Electronics Short Needle Nose Pliers (Toothed Gripping Surface)- 120 mm
H355-140	Electronics Long Needle Nose Pliers- 140 mm
H01	4 PC: 1.5x40, 2.0x60, 2.5x80, 3.0x80 mm Electronics Slotted Screwdrivers
H02	2 PC: PH00x60, PH0x60 mm Electronics Phillips Screwdrivers
H43-120-SA	Blunt Shape Tweezers- Serrated (Straight)- 120 mm

## J72-E0811

11 Piece Standard and Needle File Set



CODE NO	PIECES
J72-E0811	11
J55-108H	Hand File (Bastard) - 20 x 200 mm
J56-108H	Half-Round File (Bastard) - 20 x 200 mm
J57-108H	Round File (Bastard) - 07.5 x 200 mm
J58-108H	Square File (Bastard) - 8 x 200 mm
J59-108H	Three Square File (Bastard) - 15 x 200 mm
J75-R06	6 PC: Needle File Set

## JP99-E06

6 Piece Measuring and Cutting Tool Set



CODE NO	PIECES
JP99-E06	6
J04-250S	Aviation Tin Snips (Straight Cut)- 250 mm
R35CT	Carbide Tipped Scriber- 145 mm
J45C	Compact Utility Knife - 18 mm
P05-0519	Compact Tape Measure (5 M x 19 mm)
P15-030	Stainless Steel Rule- 30 cm
P54-20S	Feeler Gauge (Metric) - 20 Leaf (0,05 - 1,0 mm)



## L99-E02

2 Piece Hammer Set



CODE NO	PIECES
L99-E02	2
L01-500	Machinist's Hammer - 500 gr
L12-40	Soft Face Hammer - Ø 40 mm

## L99-E08

8 Piece Hammer and Chisel Set

new  
content

CODE NO	PIECES
L99-E08	8
L01-500	Machinist's Hammer - 500 gr
L12-40	Soft Face Hammer - Ø 40 mm
L25-200-2	Flat Chisel - 24 x 200 mm
L29-4	Centre Punch - Ø4 x 120 mm
L31	4 PC: Ø(3, 4, 5, 6) x 150 mm Parallel Pin Punch

## R99-E24

24 Piece General Maintenance Set



CODE NO	PIECES
R99-E24	24
R21-P19	19 PC: 1, 1.5, 2, 2.5, 3, 3.5, 4, 4.5, 5, 5.5, 6, 6.5, 7, 7.5, 8, 8.5, 9, 9.5, 10 mm Drill Bit Set
R15-MPL	Pocket LED Flashlight (with Magnetic Pickup)
J45C	Compact Utility Knife - 18 mm
P05-0519	Compact Tape Measure (5 M x 19 mm)
P15-030	Stainless Steel Rule - 30 cm
P54-205	Feeler Gauge (Metric) - 20 Leaf (0,05 - 1,0 mm)

## AE00

5 Division Idle EVA Module (for Storage of Parts)



CODE NO	PIECES
AE00	-

This module is especially useful to complete 2 drawer modules to 3 modules, can be used for storage of fasteners such as screws, nuts, washers etc.

## R99-E32

32 Piece Drill Bit and Impact Screwdriver Set



CODE NO	PIECES
R99-E32	32
R21-P19	19 PC: 1, 1.5, 2, 2.5, 3, 3.5, 4, 4.5, 5, 5.5, 6, 6.5, 7, 7.5, 8, 8.5, 9, 9.5, 10 mm Drill Bit Set
R15-1000	Magnetic Pick-Up Tool (Cap: 1000 gr)- 400 mm
F28/BT	5/16" Impact Bit Driver
CB/516SL	10 mm 5/16" Drive Slotted Bit (Impact Grade)
CB/516PH	3 PC: PH2, PH3, PH4 5/16" Drive Phillips Bits (Impact Grade)
CB/516TX	4 PC: T30, T40, T45, T50 5/16" Drive TORX Bits (Impact Grade)
CB/516HX	3 PC: 5, 6, 8 mm 5/16" Drive Hexagon Bits (Impact Grade)

## R01-E05

5 Piece Hand Riveter Set



CODE NO	PIECES
R01-E05	5
R01-260	Hand Riveter - 265 mm
BR	4x20 PC: 2.4x6, 3.2x8, 4x12, 4.8x20 mm Blind Riveters

## N14-E11

11 Piece Oil Service Tool Set



CODE NO	PIECES
N14-E11	11
N14-0615	Oil Filter Band Wrench (65-100 mm)
N14-10	Oil Drain Plug Wrench - 285 mm (8 x 10 mm)
N14-12S	3 PC: 8, 10, 12 mm 3/8" Drive Square Oil Drain Plug Socket
N14-12H	5 PC: 8, 10, 12, 14, 17 mm 3/8" Drive Hexagon Oil Drain Plug Socket
C11-405	3/8" Drive Sliding T-Handle - 165 mm

## N23-E05

5 Piece Wheel Service Tool Set

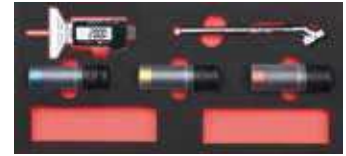

CODE NO	PIECES
N23-E05	5
C64W-H	3 PC: 17, 19, 21 mm 1/2" Drive DuraMAX Impact Wheel Nut Socket
N23-08TD	Digital Tyre Tread Depth Gauge - (0-25 mm)
N23-0831	Tyre Pressure Gauge (for Cars) 10 - 120 psi

## N43-E09

9 Piece Auto Electrician Set



CODE NO	PIECES
N43-E09	9
G09-11	Car Electric Circuit Tester - 6/24 DC (V)
G09-16	Car Electric Circuit Tester - Pro - 3/48 DC (V)
E69-YT1	Crimping Pliers for Insulated Terminals (0.5 - 6.0 mm²)
KYK	6 SET: Cable Terminal Kit

## N17-E08

8 Piece Special Automotive Socket Set



CODE NO	PIECES
N17-E08	8
N17-05	3 PC: 22x78, 22x110, 27x78 mm 1/2" Drive Diesel Injector Sockets
N18-15S	3/8" Drive Oxygen (Lambda) Sensor Socket - 22x90 mm
C17-R14C	3/8" Drive 14 mm 12 Point Spark Plug Socket (Retaining Clip)
C27-R	2 PC: 16, 21 mm 1/2" Drive Spark Plug Sockets (Retaining Rubber)
C21-915	1/2" Socket Adaptor - F:1/2" M:3/8"

new  
content

# GT MAX

The Ultimate Roller Cabinet Range



General Purpose Tool Set

# JUNIOR

new

# 121 PIECE

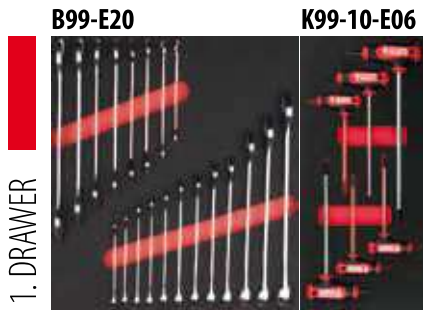

- 1. DRAWER**
- B01 12 PC**  
6, 7, 8, 9, 10, 11, 12, 13, 14, 17, 19, 22 mm
  - B09 8 PC**  
6x7, 8x9, 10x11, 12x13, 14x15, 16x17, 18x19, 20x22 mm
  - K10 6 PC**  
2, 2.5, 3, 4, 5, 6 mm

- 2. DRAWER**
- C02-H 11 PC**  
4, 5, 5.5, 6, 7, 8, 9, 10, 11, 12, 13 mm
  - BT/8001**  
1/4"-1/4"
  - CB/1800 4 PC**  
3, 4, 5, 6 mm
  - CB/250 2 PC**  
PH1, PH2
  - CB/350 2 PC**  
PZ1, PZ2
  - CB/610 3 PC**  
4, 5.5, 6.5 mm
  - CB/800 6 PC**  
T10, T15, T20, T25, T30, T40
  - C01-12**
  - C01-20**

- F26/BT**
- C01-40**
- C01-73**  
100 mm
- C01-80**
- C22-H 16 PC**  
10, 11, 12, 13, 14, 15, 16, 17, 18, 19, 21, 22, 24, 27, 30, 32 mm
- C21-12**
- C21-40**
- C21-70 2 PC**  
125 mm, 250 mm
- C21-80**
- BT/8007**  
1/2" - 5/16"
- CB/516SL10**  
10 mm
- CB/516PH 3 PC**  
PH2, PH3, PH4
- CB/516TX 4 PC**  
T30, T40, T45, T50

- 3. DRAWER**
- CB/516HX 3 PC**  
5, 6, 8 mm
  - 4100M 4 PC**  
3, 4, 5.5, 6.5 mm
  - 4200M 2 PC**  
PH1, PH2
  - 1300M 5 PC**  
6, 7, 8, 10, 13
  - LT/9 9 PC**  
1.5, 2, 2.5, 3, 4, 5, 6, 8, 10 mm
  - 6105CP**  
3 mm
  - E01-41-0180**  
180 mm
  - E06-41-0160**  
160 mm
  - E15-41-0160**  
160 mm
  - E30-54-0250**  
250 mm
  - L01-500**  
500 mm
  - L25-200-2**  
24x200 mm

## 121 Piece Tool Kit

Contents Only



## 121 Piece Tool Kits in Roller Cabinets

(A50TK-121+A01-06)

(A50TK-121+A02-06)



**GT PLUS**  
6 DRAWER



**GT**  
6 DRAWER

CODE NO **A50TK-121**

**A50TK-121A01**

**A50TK-121A02**

# 01 Tool Containers and Assortments

General Purpose Tool Set

## JUNIOR

**new** 123 PIECE

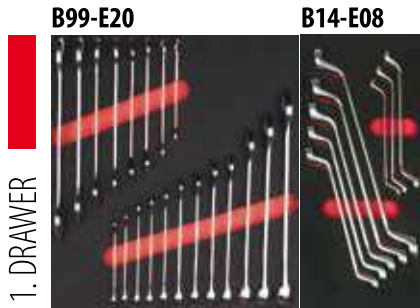

1. DRAWER



2. DRAWER



3. DRAWER

**1. DRAWER**

- B01 12 PC**  
6, 7, 8, 9, 10, 11, 12, 13, 14, 17, 19, 22 mm
- B09 8 PC**  
6x7, 8x9, 10x11, 12x13, 14x15, 16x17, 18x19, 20x22 mm
- B14 8 PC**  
6x7, 8x9, 10x11, 12x13, 14x15, 16x17, 18x19, 20x22 mm

**2. DRAWER**

- C02-H 11 PC**   
4, 5, 5.5, 6, 7, 8, 9, 10, 11, 12, 13 mm
- BT/8001**   
1/4"-1/4"
- CB/1800 4 PC**   
3, 4, 5, 6 mm
- CB/250 2 PC**   
PH1, PH2
- CB/350 2 PC**   
PZ1, PZ2
- CB/610 3 PC**   
4, 5.5, 6.5 mm
- CB/800 6 PC**   
T10, T15, T20, T25, T30, T40
- C01-12**

- C01-20**
- F26/BT**
- C01-40**
- C01-73**   
100 mm
- C01-80**
- C22-H 16 PC**   
10, 11, 12, 13, 14, 15, 16, 17, 18, 19, 21, 22, 24, 27, 30, 32 mm
- C21-12**
- C21-40**
- C21-70 2 PC**   
125 mm, 250 mm
- C21-80**
- BT/8007**  
1/2" - 5/16"
- CB/516SL10**   
10 mm
- CB/516PH 3 PC**   
PH2, PH3, PH4
- CB/516TX 4 PC**   
T30, T40, T45, T50

- CB/516HX 3 PC**   
5, 6, 8 mm
- 3. DRAWER**
- 4100M 4 PC**   
3, 4, 5.5, 6.5 mm
- 4200M 2 PC**   
PH1, PH2
- 1300M 5 PC**   
6, 7, 8, 10, 13
- LT/9 9 PC**   
1.5, 2, 2.5, 3, 4, 5, 6, 8, 10 mm
- 6105CP**   
3 mm
- E01-41-0180**  
180 mm
- E06-41-0160**  
160 mm
- E15-41-0160**  
160 mm
- E30-54-0250**  
250 mm
- L01-500**  
500 mm
- L25-200-2**  
24x200 mm

### 123 Piece Tool Kit

Contents Only



### 123 Piece Tool Kits in Roller Cabinets

(A50TK-123+A01-06)

(A50TK-123+A02-06)



**GT PLUS**  
6 DRAWER



**GT**  
6 DRAWER

CODE NO **A50TK-123**

**A50TK-123A01**

**A50TK-123A02**

General Purpose Tool Set

# JUNIOR

**new**

# 164 PIECE

1. DRAWER

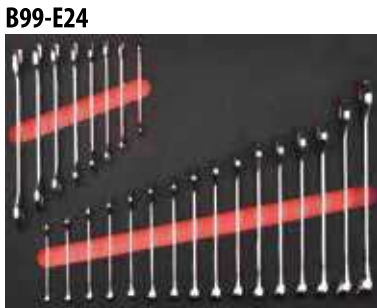

**B99-E24**

2. DRAWER



**C99-E68H2**

3. DRAWER



**EF-E72**

**1. DRAWER**

**B01 16 PC**  
6, 7, 8, 9, 10, 11, 12, 13, 14, 15, 16, 17, 18, 19, 22, 24 mm

**B09 8 PC**  
6x7, 8x9, 10x11, 12x13, 14x15, 16x17, 18x19, 20x22 mm

**2. DRAWER**

**C02-H 11 PC**   
4, 5, 5.5, 6, 7, 8, 9, 10, 11, 12, 13 mm

**BT/8001**   
1/4"-1/4"

**CB/1800 4 PC**   
3, 4, 5, 6 mm

**CB/250 2 PC**   
PH1, PH2

**CB/350 2 PC**   
PZ1, PZ2

**CB/610 3 PC**   
4, 5.5, 6.5 mm

**CB/800 6 PC**   
T10, T15, T20, T25, T30, T40

**C01-12**

**C01-20**

**F26/BT**

**C01-40**

**C01-73**   
100 mm

**C01-80**

**C22-H 16 PC**   
10, 11, 12, 13, 14, 15, 16, 17, 18, 19, 21, 22, 24, 27, 30, 32 mm

**C21-12**

**C21-40**

**C21-70 2 PC**   
125 mm, 250 mm

**C21-80**

**BT/8007**  
1/2" - 5/16"

**CB/516SL10**   
10 mm

**CB/516PH 3 PC**   
PH2, PH3, PH4

**CB/516TX 4 PC**   
T30, T40, T45, T50

**CB/516HX 3 PC**   
5, 6, 8 mm

**3. DRAWER**

**F10 4 PC**   
3, 4, 5.5, 6.5 mm

**F14 2 PC**   
PH1, PH2

**LT/900 9 PC**   
1.5, 2, 2.5, 3, 4, 5, 6, 8, 10 mm

**CB/ST31 31 PC**

**6105CP**   
3 mm

**E01-41-0180**  
180 mm

**E06-41-0160**  
160 mm

**E15-41-0160**  
160 mm

**E30-54-0250**  
250 mm

**J45C**  
18 mm

**J45-R 10 PC**  
18 mm

**L01-500**  
500 mm

**L25-200-2**  
24x200 mm

**L29-4**  
4 mm

**L31 4 PC**  
3, 4, 5, 6 mm

**P05-0519**  
5M x 19 mm

**P15-030**  
30 cm

**P54-20S**  
Metric - 20 Blade

164 Piece Tool Kit

Contents Only



CODE NO **A50TK-164**

164 Piece Tool Kits in Roller Cabinets

(A50TK-164+A01-06)

(A50TK-164+A02-06)



**GT PLUS**  
6 DRAWER



**GT**  
6 DRAWER

**A50TK-164A01**

**A50TK-164A02**

# 01 Tool Containers and Assortments

General Purpose Tool Set

## MIDI - 1

**new**

**232 PIECE**

1. DRAWER

**B99-E24**

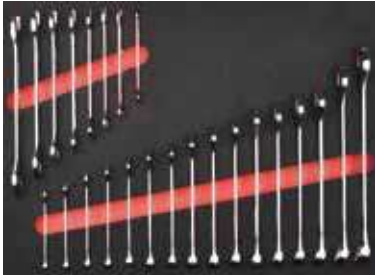

**1. DRAWER**

**B01 16 PC**  
6, 7, 8, 9, 10, 11, 12, 13, 14, 15, 16, 17, 18, 19, 22, 24 mm

**B09 8 PC**  
6x7, 8x9, 10x11, 12x13, 14x15, 16x17, 18x19, 20x22 mm

2. DRAWER

**C99-E99H2**



**2. DRAWER**

**C02-H 12 PC**   
4, 5, 5.5, 6, 7, 8, 9, 10, 11, 12, 13, 14 mm

**C04-H 11 PC**   
4, 5, 5.5, 6, 7, 8, 9, 10, 11, 12, 13 mm

**BT/8001**   
1/4"-1/4"

**CB/800T 7 PC**   
T10, T15, T20, T25, T27, T30, T40

**C08S-S 3 PC**   
4, 5.5, 6.5 mm

3. DRAWER

**F99-E81**



4. DRAWER

**EL-E28**



**C08S-PH 2 PC**   
PH1, PH2

**C08S-PZ 2 PC**   
PZ1, PZ2

**C08S-T 8 PC**   
T8, T10, T15, T20, T25, T27, T30, T40

**C08S-H 5 PC**   
3, 4, 5, 6, 8 mm

**C01-12**

**C01-20**

**C01-40**

**C01-70 2 PC**   
50 mm, 150 mm

**C01-75F**   
150 mm

**C01-80**

**C01-92**   
D:1/4" x E:3/8 mm

**C22-H 18 PC**   
8, 10, 11, 12, 13, 14, 15, 16, 17, 18, 19, 20, 21, 22, 24, 27, 30, 32 mm

**C24-H 3 PC**   
13, 17, 19 mm

**C21-12**

**C21-40**

**C21-70 2 PC**   
125 mm, 250 mm

**C21-80**

**C21-91S**   
F:1/2" - M:3/8

**C21-92**   
F:1/2" - M:3/4



BT/8007  
1/2" - 5/16"



CB/516SL10  
10 mm



CB/516PH 3 PC  
PH2, PH3, PH4



CB/516TX 4 PC  
T30, T40, T45, T50



CB/516HX 3 PC  
5, 6, 8 mm

3. DRAWER



F10 4 PC  
3, 4, 5.5, 6.5 mm



F14 2 PC  
PH1, PH2



F13-055-025  
5.5 x 25 mm



F16-002-025  
PH2 x 25 mm



F20 5 PC  
6, 7, 8, 10, 13 mm



K10 6 PC  
2, 2.5, 3, 4, 5, 6 mm

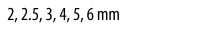

LT/900 9 PC  
1.5, 2, 2.5, 3, 4, 5, 6, 8, 10 mm



LT/700L 8 PC  
T9, T10, T15, T20, T25, T27, T30, T40



F26/BT  
T24



CB/ST31 31 PC  
PH1, PH2, PH3, PH4, T10, T15, T20, T25, T27, T30, T40



F26/RDS 12 in 1  
PH1, PH2, PH3, PH4, T10, T15, T20, T25, T27, T30, T40



6105CP  
3 mm

4. DRAWER



E01-41-0180  
180 mm



E06-41-0160  
160 mm



E15-41-0160  
160 mm



E30-54-0250  
250 mm

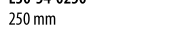

E50-240-2  
240 mm



J45CPM  
18 mm



J45-R 10 PC  
18 mm



L01-500  
500 mm



L12-40  
Ø 40 mm



L12-R40  
Ø 40 mm



L25-200-2  
24x200 mm



L29-4  
4 mm



L31 4 PC  
3, 4, 5, 6 mm

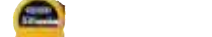

P05-0519  
5M x 19 mm



P15-030  
30 cm



P54-20S  
Metric - 20 Blade

232 Piece Tool Kit

Contents Only



232 Piece Tool Kits in Roller Cabinets

(A50TK-232/1+A01M-06)

(A50TK-232/1+A01-06)

(A50TK-232/1+A02-06)



GT MAX  
6 DRAWER



GT PLUS  
6 DRAWER



GT  
6 DRAWER

CODE NO A50TK-232/1

A50TK-232/1A01M

A50TK-232/1A01

A50TK-232/1A02

# 01 Tool Containers and Assortments

General Purpose Tool Set

## MIDI - 2

**new**

**232 PIECE**

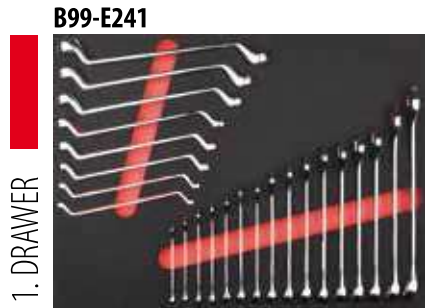

1. DRAWER

**1. DRAWER**

**B01 16 PC**  
6, 7, 8, 9, 10, 11, 12, 13, 14, 15, 16,  
17, 18, 19, 22, 24 mm

**B14 8 PC**  
6x7, 8x9, 10x11, 12x13, 14x15,  
16x17, 18x19, 20x22 mm



2. DRAWER

**2. DRAWER**

**C02-H 12 PC**   
4, 5, 5.5, 6, 7, 8, 9, 10, 11, 12,  
13, 14 mm

**C04-H 11 PC**   
4, 5, 5.5, 6, 7, 8, 9, 10, 11, 12, 13 mm

**BT/8001**   
1/4"-1/4"

**CB/800T 7 PC**   
T10, T15, T20, T25, T27, T30, T40

**3 PC**   
4, 5.5, 6.5 mm



3. DRAWER



4. DRAWER

**C08S-PH 2 PC**   
PH1, PH2

**C08S-PZ 2 PC**   
PZ1, PZ2

**C08S-T 8 PC**   
T8, T10, T15, T20, T25, T27, T30, T40

**C08S-H 5 PC**   
3, 4, 5, 6, 8 mm

**C01-12**

**C01-20**

**C01-40**

**C01-70 2 PC**   
50 mm, 150 mm

**C01-75F**   
150 mm

**C01-80**

**C01-92**   
D:1/4" x E:3/8 mm

**C22-H 18 PC**   
8, 10, 11, 12, 13, 14, 15, 16, 17, 18,  
19, 20, 21, 22, 24, 27, 30, 32 mm

**C24-H 3 PC**   
13, 17, 19 mm

**C21-12**

**C21-40**

**C21-70 2 PC**   
125 mm, 250 mm

**C21-80**

**C21-91S**   
F:1/2" - M:3/8

**C21-92**   
F:1/2" - M:3/4



BT/8007  
1/2" - 5/16"



CB/516SL10  
10 mm



CB/516PH 3 PC  
PH2, PH3, PH4



CB/516TX 4 PC  
T30, T40, T45, T50



CB/516HX 3 PC  
5, 6, 8 mm

3. DRAWER



F10 4 PC  
3, 4, 5.5, 6.5 mm



F14 2 PC  
PH1, PH2



F13-055-025  
5.5 x 25 mm



F16-002-025  
PH2 x 25 mm



F20 5 PC  
6, 7, 8, 10, 13 mm



K10 6 PC  
2, 2.5, 3, 4, 5, 6 mm



LT/900 9 PC  
1.5, 2, 2.5, 3, 4, 5, 6, 8, 10 mm



LT/700L 8 PC  
T9, T10, T15, T20, T25, T27, T30, T40



F26/BT



CB/ST31 31 PC



F26/RDS 12 in 1



6105CP  
3 mm

4. DRAWER



E01-41-0180  
180 mm



E06-41-0160  
160 mm



E15-41-0160  
160 mm



E30-54-0250  
250 mm



E50-240-2  
240 mm



J45CPM  
18 mm



J45-R 10 PC  
18 mm



L01-500  
500 mm



L12-40  
Ø 40 mm



L12-R40  
Ø 40 mm



L25-200-2  
24x200 mm



L29-4  
4 mm



L31 4 PC  
3, 4, 5, 6 mm



P05-0519  
5M x 19 mm



P15-030  
30 cm



P54-20S  
Metric - 20 Blade

232 Piece Tool Kit

Contents Only



232 Piece Tool Kits in Roller Cabinets

(A50TK-232/2+A01M-06)

(A50TK-232/2+A01-06)

(A50TK-232/2+A02-06)



GT MAX  
6 DRAWER



GT PLUS  
6 DRAWER



GT  
6 DRAWER

CODE NO	A50TK-232/2	A50TK-232/2A01M	A50TK-232/2A01	A50TK-232/2A02
---------	-------------	-----------------	----------------	----------------

# 01 Tool Containers and Assortments

General Purpose Tool Set

## MIDI - SAE

**new**

**230 PIECE**

1. DRAWER

### B99A-E26

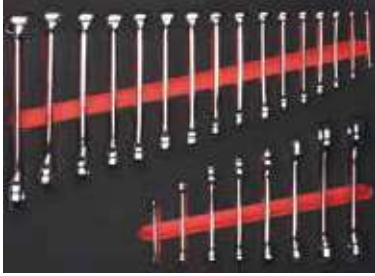

2. DRAWER

### C99A-E96BMR



3. DRAWER

### F99A-E80



4. DRAWER

### EL-E28



#### 1. DRAWER



#### B01A 16 PC

1/4, 5/16, 3/8, 7/16, 1/2, 9/16, 5/8, 11/16, 3/4, 13/16, 7/8, 15/16, 1, 1 1/16, 1 1/8, 1 1/4 inch



#### B09A 10 PC

1/4x5/16, 5/16x3/8, 7/16x1/2, 1/2x9/16, 9/16x5/8, 5/8x3/4, 11/16x3/4, 13/16x7/8, 15/16x1, 1-1/16x1-1/8 inch

#### 2. DRAWER



#### C02A-B 10 PC

3/16, 7/32, 1/4, 9/32, 5/16, 11/32, 3/8, 7/16, 1/2, 9/16 inch



#### C04A-B 10 PC

3/16, 7/32, 1/4, 9/32, 5/16, 11/32, 3/8, 7/16, 1/2, 9/16 inch



#### BT/8001

1/4"-1/4"



#### CB/800T 7 PC

T10, T15, T20, T25, T27, T30, T40



#### C08S-S 3 PC

4, 5.5, 6.5 mm



#### C08S-PH 2 PC

PH1, PH2



#### C08S-PZ 2 PC

PZ1, PZ2



#### C08S-T 8 PC

T8, T10, T15, T20, T25, T27, T30, T40



#### C08AS-H 11 PC

1/16, 5/64, 3/32, 7/64, 1/8, 9/64, 5/32, 3/16, 7/32, 1/4, 5/16 inch



#### C01-T90



#### C01-20



#### C01-40



#### C01-70 2 PC

50 mm, 150 mm



#### C01-75F

150 mm



#### C01-80



#### C01-92

F:1/4" x M:3/8 mm



#### C22A-B 15 PC

3/8, 7/16, 1/2, 9/16, 5/8, 11/16, 3/4, 13/16, 7/8, 15/16, 1, 1-1/16, 1-1/8, 1-3/16, 1-1/4 inch



#### C21-T90



#### C21-40



#### C21-70 2 PC

125 mm, 250 mm



#### C21-80



#### C21-91S

F:1/2" - M:3/8



#### C21-92

F:1/2" - M:3/4



BT/8007  
1/2" - 5/16"



CB/516SL10  
10 mm



CB/516PH 3 PC  
PH2, PH3, PH4



CB/516TX 4 PC  
T30, T40, T45, T50



CB/516HX 3 PC  
5, 6, 8 mm

3. DRAWER



F14 2 PC  
PH1, PH2



F13-055-025  
5.5 x 25 mm



F16-002-025  
PH2 x 25 mm



F20A 3 PC  
1/4, 5/16, 3/8 inch



K10A 7 PC  
5/64, 3/32, 1/8, 5/32, 3/16, 1/4, 5/16 inch



LT/900AF 9 PC  
1/16, 5/64, 3/32, 1/8, 5/32, 3/16, 1/4, 5/16, 3/8 inch



LT/700L 8 PC  
T9, T10, T15, T20, T25, T27, T30, T40



F26/BT



CB/ST31 31 PC



F26/RDS 12 in 1



6105CP  
3 mm

4. DRAWER



E01-41-0180  
180 mm



E06-41-0160  
160 mm



E15-41-0160  
160 mm



E30-54-0250  
250 mm



E50-240-2  
240 mm



J45CPM  
18 mm



J45-R 10 PC  
18 mm



L01-500  
500 mm



L12-40  
Ø 40 mm



L12-R40  
Ø 40 mm



L25-200-2  
24x200 mm



L29-4  
4 mm



L31 4 PC  
3, 4, 5, 6 mm



P05-0519  
5M x 19 mm

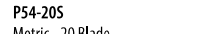

P15-030  
30 cm



P54-20S  
Metric - 20 Blade

230 Piece Tool Kit

Contents Only



230 Piece Tool Kits in Roller Cabinets

(A50TK-230+A01M-06)

(A50TK-230+A01-06)

(A50TK-230+A02-06)



GT MAX  
6 DRAWER



GT PLUS  
6 DRAWER



GT  
6 DRAWER

CODE NO A50TK-230

A50TK-230A01M

A50TK-230A01

A50TK-230A02

# 01 Tool Containers and Assortments

General Purpose Tool Set

## MAXI

**new**

# 275 PIECE

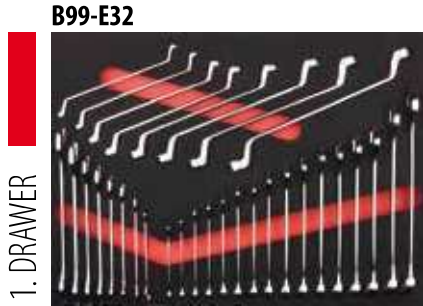

1. DRAWER

**1. DRAWER**

**B01 16 PC**  
16 PC: 6, 7, 8, 9, 10, 11, 12, 13, 14, 15, 16, 17, 18, 19, 22, 24 mm

**B09 8 PC**  
6x7, 8x9, 10x11, 12x13, 14x15, 16x17, 18x19, 20x22 mm

**B14 8 PC**  
6x7, 8x9, 10x11, 12x13, 14x15, 16x17, 18x19, 20x22 mm



2. DRAWER

**2. DRAWER**

**C02-H 12 PC**   
4, 5, 5.5, 6, 7, 8, 9, 10, 11, 12, 13, 14 mm

**C04-H 11 PC**   
4, 5, 5.5, 6, 7, 8, 9, 10, 11, 12, 13 mm

**BT/8001**   
1/4"-1/4"

**CB/800T 7 PC**   
T10, T15, T20, T25, T27, T30, T40

**C08S-S 3 PC**   
4, 5.5, 6.5 mm



3. DRAWER



4. DRAWER



5. DRAWER

**C08S-PH 2 PC**   
PH1, PH2

**C08S-PZ 2 PC**   
PZ1, PZ2

**C08S-T 8 PC**   
T8, T10, T15, T20, T25, T27, T30, T40

**C08S-H 5 PC**   
3, 4, 5, 6, 8 mm

**C01-12**   
125 mm, 250 mm

**C01-20**   
125 mm, 250 mm

**C01-40**   
125 mm, 250 mm

**C01-70 2 PC**   
50 mm, 150 mm

**C01-75F**   
150 mm

**C01-80**   
10 mm

**C01-92**   
D: 1/4" x E: 3/8 mm



**C22-H 18 PC**   
8, 10, 11, 12, 13, 14, 15, 16, 17, 18, 19, 20, 21, 22, 24, 27, 30, 32 mm



**C24-H 3 PC**   
13, 17, 19 mm



**C21-12**



**C21-40**



**C21-70 2 PC**   
125 mm, 250 mm



**C21-80**



**C21-91S**   
F: 1/2" - M: 3/8



**C21-92**   
F: 1/2" - M: 3/4



**BT/8007**   
1/2" - 5/16"



**CB/516SL10**   
10 mm

**CB/516PH 3 PC** ⊕  
PH2, PH3, PH4

**CB/516TX 4 PC** ⊕  
T30, T40, T45, T50

**CB/516HX 3 PC** ○  
5, 6, 8 mm

**3. DRAWER**

**F10 4 PC** ●  
3, 4, 5.5, 6.5 mm

**F14 2 PC** ⊕  
PH1, PH2

**F13-055-025** ●  
5.5 x 25 mm

**F16-002-025** ⊕  
PH2 x 25 mm

**F20 5 PC** ●  
6, 7, 8, 10, 13 mm

**K10 6 PC** ○  
2, 2.5, 3, 4, 5, 6 mm

**LT/900 9 PC** ○  
1.5, 2, 2.5, 3, 4, 5, 6, 8, 10 mm

**LT/700L 8 PC** ⊕  
T9, T10, T15, T20, T25, T27, T30, T40

**F26/BT** ●

**CB/ST31 31 PC** ● ⊕ ⊕ ⊕ ⊕ ⊕ ○

**F26/RDS 12 in 1**

**6105CP** ●  
3 mm

**4. DRAWER**

**E01-41-0180**  
180 mm

**E06-41-0160**  
160 mm

**E15-41-0200**  
200 mm

**E16-41-0200**  
200 mm

**E30-54-0250**  
250 mm

**E50-240-2**  
240 mm

**E65-44-0180**  
19-60 mm

**E66-44-0180**  
19-60 mm

**E67-44-0180**  
19-60 mm

**E68-44-0180**  
19-60 mm

**5. DRAWER**

**J55-108H**  
20 x 200 mm Bastard

**J56-108H**  
20 x 200 mm Bastard

**J57-108H**  
Ø7.5 x 200 mm Bastard

**J58-108H**  
8 x 200 mm Bastard

**J59-108H**  
15 x 200 mm Bastard

**J75-R06 6 PC**

**J45CPM**  
18 mm

**J45-R 10 PC**  
18 mm

**L01-500**  
500 mm

**L12-40**  
Ø 40 mm

**L12-R40**  
Ø 40 mm

**L25-200-2**  
24x200 mm

**L29-4**  
4 mm

**L31 4 PC**  
3, 4, 5, 6 mm

**P05-0519**  
5M x 19 mm

**P15-030**  
30 cm

**P54-20S**  
Metric - 20 Blade

**R21-P19 19 PC**  
1, 1.5, 2, 2.5, 3, 3.5, 4, 4.5, 5, 5.5, 6, 6.5, 7, 7.5, 8, 8.5, 9, 9.5, 10 mm

**275 Piece Tool Kit**

Contents Only



CODE NO **A50TK-275**

**275 Piece Tool Kits in Roller Cabinets**

(A50TK-275+A01M-07)

(A50TK-275+A01-07)



**GT MAX**  
7 DRAWER



**GT PLUS**  
7 DRAWER

**A50TK-275A01M**

**A50TK-275A01**

# 01 Tool Containers and Assortments

General Purpose Tool Set

## SUPER MAXI

new

343 PIECE

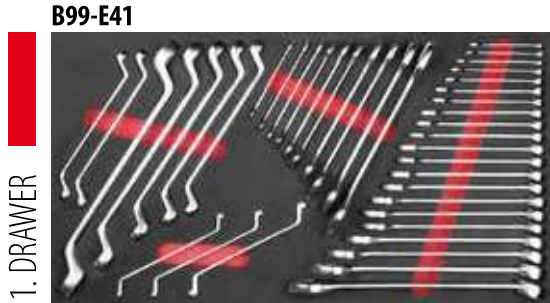

B99-E41

1. DRAWER

**B01 21 PC**  
6, 7, 8, 9, 10, 11, 12, 13, 14, 15, 16, 17, 18, 19, 20, 21, 22, 24, 27, 30, 32 mm

**B09 10 PC**  
6x7, 8x9, 10x11, 12x13, 14x15, 16x17, 18x19, 20x22, 24x27, 30x32 mm

**B14 10 PC**  
6x7, 8x9, 10x11, 12x13, 14x15, 16x17, 18x19, 20x22, 24x27, 30x32 mm

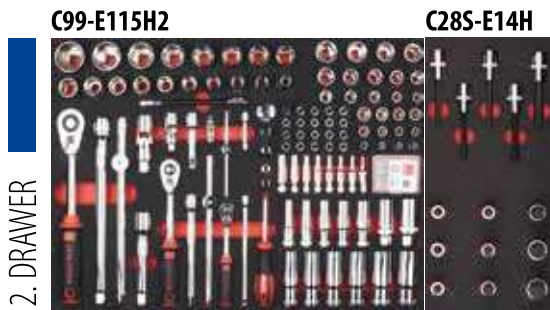

C99-E115H2

C28S-E14H

2. DRAWER

**C02-H 12 PC**   
4, 5, 5.5, 6, 7, 8, 9, 10, 11, 12, 13, 14 mm

**C04-H 8 PC**   
4, 5, 5.5, 6, 7, 8, 9, 10 mm

**C08S-S 3 PC**   
4, 5.5, 6.5 mm

**C08S-PH 2 PC**   
PH1, PH2

**C08S-PZ 2 PC**   
PZ1, PZ2

**C08S-T 8 PC**   
T8, T10, T15, T20, T25, T27, T30, T40

**C08S-H 5 PC**   
3, 4, 5, 6, 8 mm

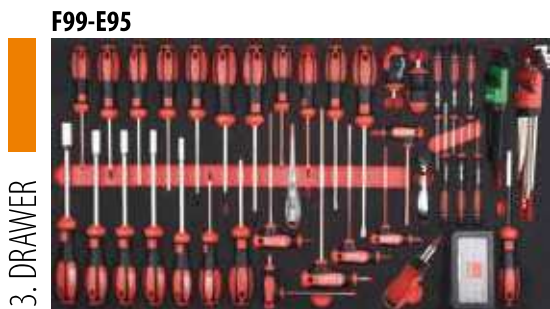

F99-E95

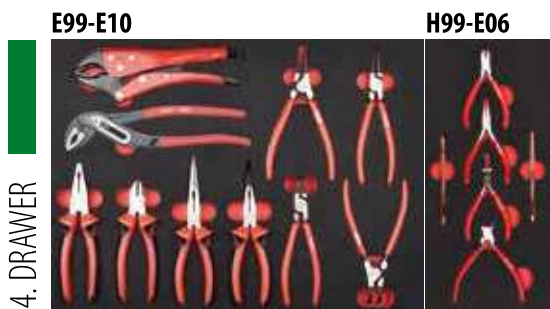

E99-E10

H99-E06

**C01-12**   
12 mm

**C01-20**   
20 mm

**C01-40**   
40 mm

**C01-70 2 PC**   
50 mm, 150 mm

**C01-75F**   
150 mm



JLR-E62

**C01-80**   
80 mm

**C01-92**   
F:1/4" x M:3/8 mm

**BT/8001**   
1/4"-1/4"

**CB/800T 7 PC**   
T10, T15, T20, T25, T27, T30, T40

**C12-H 14 PC**   
8, 9, 10, 11, 12, 13, 14, 15, 16, 17, 18, 19, 21, 22 mm

**C14-H 5 PC**   
11, 12, 13, 14, 15 mm

**C11-12**   
12 mm

**C11-40**   
40 mm

**C11-70 2 PC**   
75 mm, 150 mm

**C11-80**   
80 mm

**C11-91**   
F:3/8" x M:1/4"

**C11-92S**   
F:3/8" x M:1/2"

**C22-H 18 PC**   
8, 10, 11, 12, 13, 14, 15, 16, 17, 18, 19, 20, 21, 22, 24, 27, 30, 32 mm

**C24-H 6 PC**   
16, 17, 18, 19, 22, 24 mm

**C27-R 2 PC**   
16, 21 mm

**C21-12**   
12 mm

**C21-40**   
40 mm

**C21-70 2 PC**   
125 mm, 250 mm

**C21-80**   
80 mm

**C21-91S**   
F:1/2" x M:3/8"

**C21-92**   
F:1/2" x M:3/4"

**C28S-HL 9 PC**   
5, 6, 7, 8, 10, 12, 14, 17, 19 mm

**C28S-HL 5 PC**   
5, 6, 8, 10, 12 mm

**C28S-HL 5 PC**   
5, 6, 8, 10, 12 mm

**3. DRAWER**

**F10 4 PC**   
3, 4, 5.5, 6.5 mm

**F14 2 PC**   
PH1, PH2

**F13-055-025**   
5.5 x 25 mm

**F16-002-025**   
PH2 x 25 mm

**F18 7 PC**   
T10, T15, T20, T25, T27, T30, T40

**F20 5 PC**   
6, 7, 8, 10, 13 mm

**H01 4 PC**   
1.5, 2, 2.5, 3 mm

**H02 2 PC**   
PH00, PH0



**K10 6 PC** ○  
2, 2.5, 3, 4, 5, 6 mm



**LT/900 9 PC** ○  
1.5, 2, 2.5, 3, 4, 5, 6, 8, 10 mm



**LT/700L 8 PC** ○  
T9, T10, T15, T20, T25, T27, T30, T40



**F26/BT** ●



**CB/ST31 31 PC** ○ ⊕ ⊖ ⊕ ⊖ ○



**F26/RDS 12 in 1**

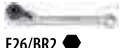

**F26/BR2** ●



**6105CP** ●  
3 mm

**4. DRAWER**



**E01-41-0180**  
180 mm



**E06-41-0160**  
160 mm



**E15-41-0200**  
200 mm



**E16-41-0200**  
200 mm



**E30-54-0250**  
250 mm



**E50-240-2**  
240 mm



**E65-44-0180**  
19-60 mm



**E66-44-0180**  
19-60 mm



**E67-44-0180**  
19-60 mm



**E68-44-0180**  
19-60 mm



**H305-110SB**  
110 mm



**H315-120SB**  
120 mm



**H335-120**  
120 mm



**H37-120**  
120 mm



**H43-120-SA**  
120 mm



**H43-125B-SA**  
125 mm

**5. DRAWER**



**J55-108H**  
20 x 200 mm Bastard



**J56-108H**  
20 x 200 mm Bastard



**J57-108H**  
Ø7.5 x 200 mm Bastard



**J58-108H**  
8 x 200 mm Bastard



**J59-108H**  
15 x 200 mm Bastard



**J75-R06 6 PC**



**J45CPM**  
18 mm



**J45-R 10 PC**  
18 mm



**L01-500**  
500 mm



**L12-40**  
Ø40 mm



**L12-R40**  
Ø40 mm

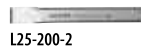

**L25-200-2**  
24x200 mm



**L29-4**  
4 mm



**L31 4 PC**  
3, 4, 5, 6 mm



**P05-0519**  
5M x 19 mm



**P15-030**  
30 cm



**P54-20S**  
Metric - 20 Blade



**R11-PEN**  
100 Lumens



**R15-1000**  
1000 gr



**R21-P19 19 PC**  
1, 1.5, 2, 2.5, 3, 3.5, 4, 4.5, 5, 5.5, 6, 6.5, 7, 7.5, 8, 8.5, 9, 9.5, 10 mm



**R35CT**  
30 mm



**R36-1**



**R36-2**



**R36-3**



**R36-4**



**R37-25**



**R40-4**  
275 mm

**343 Piece Tool Kit**

Contents Only



CODE NO **A50TK-343**

**343 Piece Tool Kit in Roller Cabinets**

(A50TK-343+A01M-07J)

(A50TK-343+A01-07J)



**GT MAX**  
7 DRAWER



**GT PLUS**  
7 DRAWER

**A50TK-343A01M**

**A50TK-343A01**

# 01 Tool Containers and Assortments

Aerospace Tool Set

## AERO MIDI

**new**

**197 PIECE**



1. DRAWER

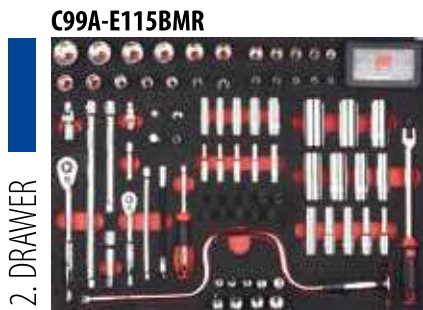

2. DRAWER



3. DRAWER



4. DRAWER

**1. DRAWER**



**B01AS**  
7/32 inch



**B01A 15 PC**  
1/4, 9/16, 5/16, 11/32, 3/8, 7/16, 1/2, 9/16, 5/8, 11/16, 3/4, 13/16, 7/8, 15/16, 1 inch



**B07A 4 PC**  
1/4x5/16, 5/16x11/32, 3/8x7/16, 1/2x9/16 inch



**B09SA 9 PC**  
7/32, 15/64, 1/4, 9/32, 5/16, 11/32, 3/8, 7/16, 1/2 inch



**B21-B 2 PC**  
150 mm, 250 mm

**2. DRAWER**



**C02A-B 10 PC**   
3/16, 7/32, 1/4, 9/32, 5/16, 11/32, 3/8, 7/16, 1/2, 9/16 inch



**C02UA 9 PC**   
7/32, 1/4, 9/32, 5/16, 11/32, 3/8, 7/16, 1/2, 9/16 inch



**C04A-B 10 PC**   
3/16, 7/32, 1/4, 9/32, 5/16, 11/32, 3/8, 7/16, 1/2, 9/16 inch



**C08AS-H 11 PC**   
1/16, 5/64, 3/32, 7/64, 1/8, 9/64, 5/32, 3/16, 7/32, 1/4, 5/16 inch



**C01-T90**



**C01-20**



**C01-70 2 PC**   
50 mm, 150 mm



**C01-75F**   
150 mm



**C01-80**



**C01-92**   
F:1/4" - M:3/8 mm



**C12A-B 13 PC**   
1/4, 5/16, 3/8, 7/16, 1/2, 9/16, 5/8, 11/16, 3/4, 13/16, 7/8, 15/16, 1 inch



**C14A-B 13 PC**   
1/4, 5/16, 3/8, 7/16, 1/2, 9/16, 5/8, 11/16, 3/4, 13/16, 7/8, 15/16, 1 inch



**C11-T90**



**C11-36MR**   
215 mm



**C11-50MR**   
420 mm



**C11-70 3 PC**   
75, 150, 250 mm



**C11-80**



**C11-91**   
F:3/8" x M:1/4"



**CB/ST31 31 PC**



**F26/BR2**



BT/8001 1/4"-1/4"



BT/8003

3. DRAWER



F10 2 PC 5.5, 8.0 mm



F14 3 PC PH0, PH1, PH2



3100/TF2



Z/12



Z/40



LT/900AF 9 PC 1/16, 5/64, 3/32, 1/8, 5/32, 3/16, 1/4, 5/16, 3/8 inch



K99-F2M 9 PC 0.05, 1/16, 5/64, 3/32, 7/64, 1/8, 9/64, 5/32, 3/16 inch



E01-44-0180 180 mm



E06-44-0160 160 mm



E15-44-0200 200 mm



E16-44-0160 160 mm



E30-54-0250 250 mm



E80-230R 230 mm



E50-2 2 PC 140, 190 mm

4. DRAWER



L02-16 450 gr



L12-40 Ø 40 mm



L12-R40 Ø 40 mm



L29 3 PC 3, 4, 5 mm



L31 2 PC 2, 5 mm



P05A 5M x 16 ft



P15-030 30 cm



P45A 150 mm



R.P6 Focus Flashlight



R15-0500 500 gr



R16-700 700 gr



R20R Ø 50 - 25/90cm



J475PQ 19 cm



R35DE 235 mm

197 Piece Tool Kit

Contents Only



CODE NO A50AS-197

197 Piece Tool Kits in Roller Cabinets

(A50AS-197+A01M-06)

(A50AS-197+A01-06)



GT MAX 6 DRAWER



GT PLUS 6 DRAWER

A50AS-197A01M

A50AS-197A01

# 01 Tool Containers and Assortments

Automotive Tool Set

## AUTO MAXI

**new**

**293 PIECE**

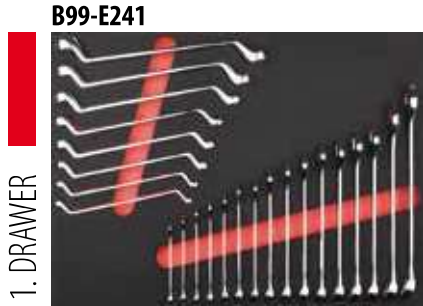

1. DRAWER

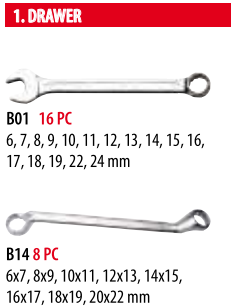

2. DRAWER



3. DRAWER

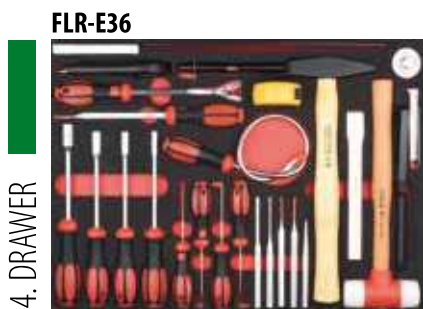

4. DRAWER

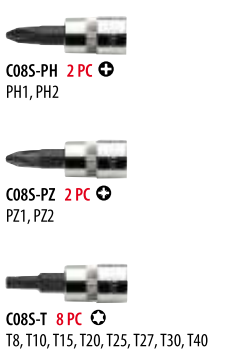

5. DRAWER

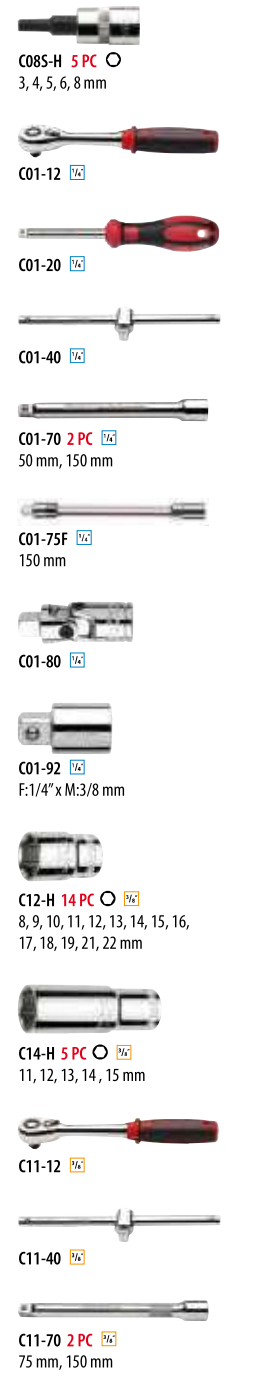

**3. DRAWER**



F10 4 PC  
3, 4, 5.5, 6.5 mm



F14 2 PC  
PH1, PH2



F13-055-025  
5.5 x 25 mm



F16-002-025  
PH2 x 25 mm



F18 7 PC  
T10, T15, T20, T25, T27, T30, T40



F26/BT



CB/ST31 31 PC



F26/RDS 12 in 1



F26/BR2



6105CP  
3 mm



G09-11



LT/900 9 PC  
1.5, 2, 2.5, 3, 4, 5, 6, 8, 10 mm



LT/700L 8 PC  
T9, T10, T15, T20, T25, T27, T30, T40



C06 6 PC  
E4, E5, E6, E7, E8, E10



C26 6 PC  
E12, E14, E16, E18, E20, E24



C28S-T 9 PC  
T20, T25, T27, T30, T40, T45, T50, T55, T60



C28S-TL 4 PC  
T30, T40, T45, T50



C28S-XL 4 PC  
M6, M8, M10, M12

**4. DRAWER**



F20 4 PC  
7, 8, 10, 13 mm



J45CPM  
18 mm



J45-R 10 PC  
18 mm



L01-500  
500 mm



L12-40  
Ø 40 mm



L12-R40  
Ø 40 mm

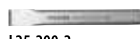

L25-200-2  
24x200 mm



L29-4  
4 mm

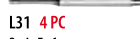

L31 4 PC  
3, 4, 5, 6 mm



N21-10



N31-12



P05-0519  
5M x 19 mm



P15-030  
30 cm



P54-20S  
Metric - 20 Blade



R11-PEN  
100 Lumens



R15-1000  
1000 gr



R36-1



R36-2



R36-3



R36-4



R37-25

**5. DRAWER**



E01-41-0180  
180 mm



E06-41-0160  
160 mm



E15-41-0200  
200 mm



E16-41-0200  
200 mm



E30-54-0250  
250 mm



E50-240-2  
240 mm



E65-44-0180  
19-60 mm



E66-44-0180  
19-60 mm



E67-44-0180  
19-60 mm



E68-44-0180  
19-60 mm

**293 Piece Tool Kit**

Contents Only



CODE NO **A50CR-293**

**293 Piece Tool Kits in Roller Cabinets**

(A50CR-293+A01M-07)

(A50CR-293+A01-07)



**GT MAX**  
7 DRAWER



**GT PLUS**  
7 DRAWER

**A50CR-293A01M**

**A50CR-293A01**

# 01 Tool Containers and Assortments

Automotive Tool Set

## AUTO SUPER MAXI

new

350 PIECE

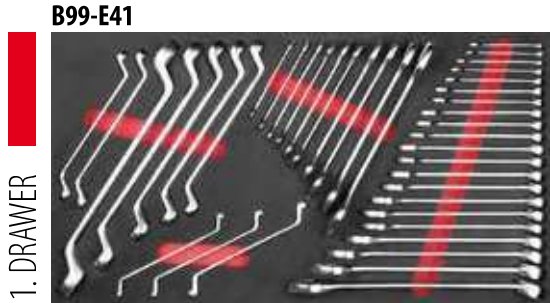

B99-E41

1. DRAWER

**B01 21 PC**  
6, 7, 8, 9, 10, 11, 12, 13, 14, 15, 16, 17, 18, 19, 20, 21, 22, 24, 27, 30, 32 mm

**B09 10 PC**  
6x7, 8x9, 10x11, 12x13, 14x15, 16x17, 18x19, 20x22, 24x27, 30x32 mm

**B14 10 PC**  
6x7, 8x9, 10x11, 12x13, 14x15, 16x17, 18x19, 20x22, 24x27, 30x32 mm

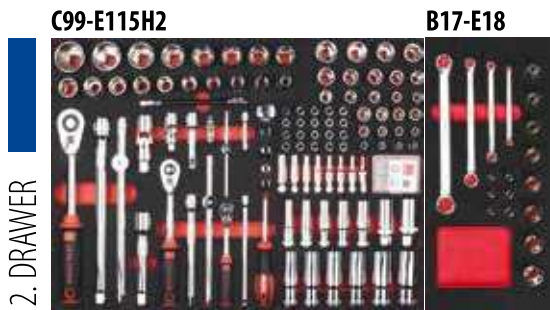

C99-E115H2

B17-E18

2. DRAWER

**C02-H 12 PC**   
4, 5, 5.5, 6, 7, 8, 9, 10, 11, 12, 13, 14 mm

**C04-H 8 PC**   
4, 5, 5.5, 6, 7, 8, 9, 10 mm

**BT/8001**

**CB/800T 7 PC**   
T10, T15, T20, T25, T27, T30, T40

**C08S-S 3 PC**   
4, 5.5, 6.5 mm

**C08S-PH 2 PC**   
PH1, PH2

**C08S-PZ 2 PC**   
PZ1, PZ2

**C08S-T 8 PC**   
T8, T10, T15, T20, T25, T27, T30, T40

**C08S-H 5 PC**   
3, 4, 5, 6, 8 mm

**C01-12**

**C01-20**

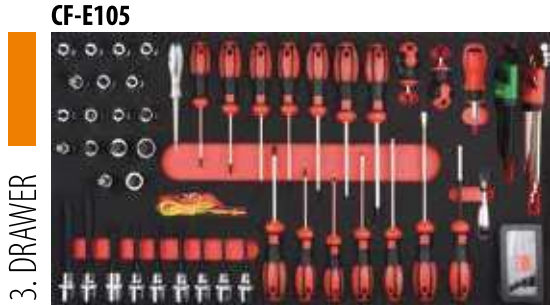

CF-E105



EL-E34

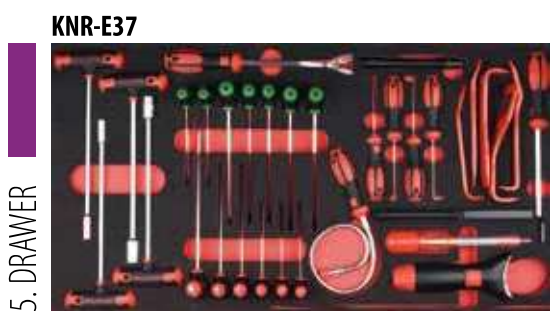

KNR-E37

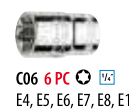
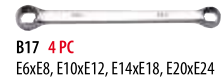
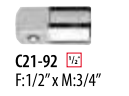
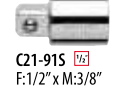
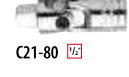
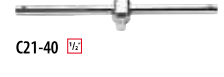
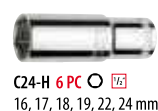
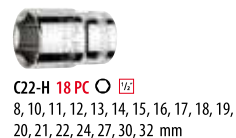
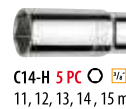
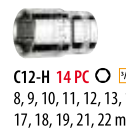
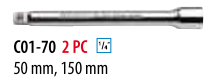

3. DRAWER





F26/BT 6.3 1/4



F26/RDS 12 in 1



CB/ST31 31 PC



F26/BR2



6105CP 3 mm



G09-11



LT/900 9 PC 1.5, 2, 2.5, 3, 4, 5, 6, 8, 10 mm



LT/700L 8 PC T9, T10, T15, T20, T25, T27, T30, T40



C285-H 7 PC 5, 6, 7, 8, 10, 12, 14 mm

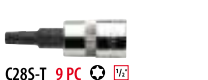

C285-T 9 PC T20, T25, T27, T30, T40, T45, T50, T55, T60



C285-TL 4 PC T30, T40, T45, T50



C285-XL 2 PC M6, M8



C285-XXL 2 PC M10, M12



C285-X14L M14



C285-X16 M16

4. DRAWER



E01-41-0180 180 mm



E06-41-0160 160 mm



E15-41-0200 200 mm



E16-41-0200 200 mm



E30-54-0250 250 mm



E50-240-2 240 mm



E65-44-0180 19-60 mm



E66-44-0180 19-60 mm



E67-44-0180 19-60 mm



E68-44-0180 19-60 mm



N12-10



J45CPM 18 mm



J45-R 10 PC 18 mm



L01-500 500 mm



L12-40 Ø 40 mm



L12-R40 Ø 40 mm



L25-200-2 24x200 mm



L29-4 4 mm



L31 4 PC 3, 4, 5, 6 mm

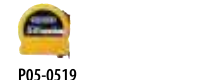

P05-0519 5M x 19 mm



P15-030 30 cm



P54-20S Metric - 20 Blade

5. DRAWER



K20 4 PC 7, 8, 10, 13 mm



K10 6 PC 2, 2.5, 3, 4, 5, 6 mm



K12 7 PC T10, T15, T20, T25, T27, T30, T40



N12-05



N14-061S Ø 60-100 mm



N14-06R x4 Ø 60-100 mm



N21-10



N31-110S 5 PC



N31-12



R11-PEN 100 Lumens

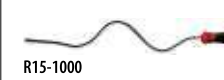

R15-1000 1000 gr



R36-1



R36-2



R36-3



R36-4



R37-25

350 Piece Tool Kit

Contents Only



CODE NO A50CR-350

350 Piece Tool Kit in Roller Cabinets

(A50CR-350+A01M-07J)

(A50CR-350+A01-07J)



GT MAX 7 DRAWER



GT PLUS 7 DRAWER

A50CR-350A01M

A50CR-350A01

# 01 Tool Containers and Assortments

Automotive Tool Set

## VW

**new**

## 292 PIECE

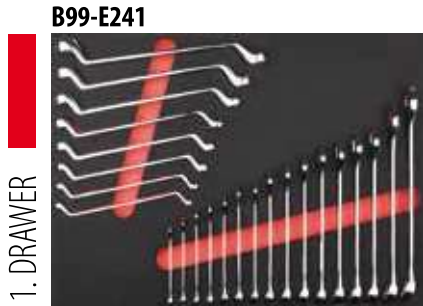

1. DRAWER

**1. DRAWER**

**B01 16 PC**  
6, 7, 8, 9, 10, 11, 12, 13, 14, 15, 16, 17, 18, 19, 22, 24 mm

**B14 8 PC**  
6x7, 8x9, 10x11, 12x13, 14x15, 16x17, 18x19, 20x22 mm

**2. DRAWER**

**C01-12**

**C01-20**

**C01-70 3 PC**   
50, 100, 150 mm

**C01-80**

**C01-92**   
F:1/4" x M:3/8 mm

**C11-91**   
F:3/8" x M:1/4"

**C11-92S**   
F:3/8" x M:1/2"

**C02-H 12 PC**   
4, 5, 5.5, 6, 7, 8, 9, 10, 11, 12, 13, 14 mm

**C06 5 PC**   
E4, E5, E6, E7, E8

**C08S-H 4 PC**   
3, 4, 5, 6 mm

**C08S-PH 2 PC**   
PH1, PH2

**C08S-S55**   
5.5 mm

**C08S-T 9 PC**   
T6, T7, T8, T9, T10, T15, T20, T25, T27

**C21-12**

**C21-40**

**C21-70W 3 PC**   
50, 125, 250 mm

**C21-80**

**C21-91S**   
F:1/2" x M:3/8"

**C21-92**   
F:1/2" x M:3/4"

**C31-91**   
F:3/4" x M:1/2"

**C22-B 17 PC**   
8, 9, 10, 12, 13, 14, 15, 16, 17, 18, 19, 21, 22, 24, 27, 30, 32 mm

**C22-H 17 PC**   
10, 11, 12, 13, 14, 15, 16, 17, 18, 19, 20, 21, 22, 24, 27, 30, 32 mm

**C26 6 PC**   
E10, E12, E14, E16, E18, E20

**C62-B 2 PC**   
32, 36 mm

**C64W-H 2 PC**   
17, 19 mm

**3. DRAWER**

**B05 6 PC**   
8, 10, 12, 13, 17, 19 mm

**C28S-H 9 PC**   
5, 6, 7, 8, 10, 12, 14, 17, 19 mm

**C28S-HBXL 4 PC**   
6, 7, 8, 10 mm



2. DRAWER



3. DRAWER



4. DRAWER



5. DRAWER



6. DRAWER



7. DRAWER

**C285-X 7 PC**   
M5, M6, M8, M10, M12, M14, M16

**C68-X18**   
M18

**C285-XL 2 PC**   
M8, M14

**C285-XXL 2 PC**   
M10, M12

**C285-T 8 PC**   
T25, T27, T30, T40, T45, T50, T55, T60

**B19-1011**  
10x11

**4. DRAWER**

**F10 4 PC**   
3, 4, 5.5, 6.5 mm

**F14 2 PC**   
PH1, PH2

**F13-055-025**   
5.5 x 25 mm

**F16-002-025**   
PH2 x 25 mm

**F26/BT**

**F26/RDS 12 in 1**

**CB/ST31 31 PC**

**F26/BR2**

**6105CP**   
3 mm

**G09-11**

**F18 7 PC**   
T10, T15, T20, T25, T27, T30, T40

**LT/900 9 PC**   
1.5, 2, 2.5, 3, 4, 5, 6, 8, 10 mm

**LT/700L 8 PC**   
T9, T10, T15, T20, T25, T27, T30, T40

**5. DRAWER**

**E01-41-0180**  
180 mm

**E06-41-0160**  
160 mm

**E15-41-0200**  
200 mm

**E16-41-0200**  
200 mm

**E30-54-0250**  
250 mm

**E50-240-2**  
240 mm

**E65-44-0180**  
19-60 mm

**E66-44-0180**  
19-60 mm

**E67-44-0180**  
19-60 mm

**E68-44-0180**  
19-60 mm

**6. DRAWER**

**F20 4 PC**   
7, 8, 10, 13 mm

**J45CPM**  
18 mm

**J45-R 10 PC**  
18 mm

**L01-500**  
500 mm

**L12-40**  
Ø 40 mm

**L12-R40**  
Ø 40 mm

**L25-200-2**  
24x200 mm

**L29-4**  
4 mm

**L31 4 PC**  
3, 4, 5, 6 mm

**N21-10**

**N31-12**

**P05-0519**  
5M x 19 mm

**P15-030**  
30 cm

**P54-20S**  
Metric - 20 Blade

**R11-PEN**  
100 Lumens

**R15-1000**  
1000 gr

**R36-1**

**R36-2**

**R36-3**

**R36-4**

**R37-25**

**7. DRAWER**

**B01 3 PC**  
27, 30, 32 mm

**B14 2 PC**  
24x27, 30x32 mm

**C21-79W**   
500 mm

**C31-40**

**N23-0750**  
500 mm

**292 Piece Tool Kit**

Contents Only



CODE NO **A50VW-292**

**292 Piece Tool Kits in Roller Cabinets**

(A50VW-292+A01M-08)

(A50VW-292+A01-08)



**GT MAX**  
8 DRAWER



**GT PLUS**  
8 DRAWER

**A50VW-292A01M**

**A50VW-292A01**

# 01 Tool Containers and Assortments

Automotive Tool Set

## MERCEDES BENZ

new

# 319 PIECE

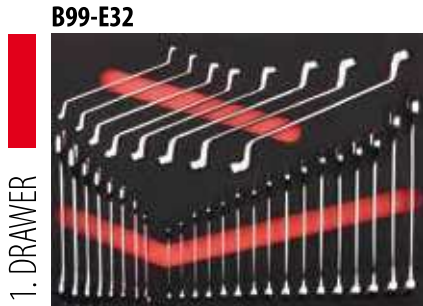

1. DRAWER

- 1. DRAWER**
- B01 16 PC**  
6, 7, 8, 9, 10, 11, 12, 13, 14, 15, 16, 17, 18, 19, 22, 24 mm
  - B09 8 PC**  
6x7, 8x9, 10x11, 12x13, 14x15, 16x17, 18x19, 20x22 mm
  - B14 8 PC**  
6x7, 8x9, 10x11, 12x13, 14x15, 16x17, 18x19, 20x22 mm



2. DRAWER

- 2. DRAWER**
- B17 4 PC**  
E6xE8, E10xE12, E14xE18, E20xE24
  - C01-12**
  - C01-20**
  - C01-40**
  - C01-70 2 PC**   
50 mm, 150 mm
  - C01-80**
  - C01-92**   
F:1/4" x M:3/8 mm
  - C02-H 12 PC**   
4, 5, 5.5, 6, 7, 8, 9, 10, 11, 12, 13, 14 mm
  - C06 5 PC**   
E4, E5, E6, E7, E8



3. DRAWER

- C01-12**
- C01-20**
- C01-40**
- C01-70 2 PC**   
50 mm, 150 mm
- C01-80**
- C01-92**   
F:1/4" x M:3/8 mm
- C02-H 12 PC**   
4, 5, 5.5, 6, 7, 8, 9, 10, 11, 12, 13, 14 mm
- C06 5 PC**   
E4, E5, E6, E7, E8



4. DRAWER

- C01-12**
- C01-20**
- C01-40**
- C01-70 2 PC**   
50 mm, 150 mm
- C01-80**
- C01-92**   
F:1/4" x M:3/8 mm
- C02-H 12 PC**   
4, 5, 5.5, 6, 7, 8, 9, 10, 11, 12, 13, 14 mm
- C06 5 PC**   
E4, E5, E6, E7, E8



5. DRAWER



6. DRAWER

- C08S-H 5 PC**   
3, 4, 5, 6, 8 mm
- C08S-PH 2 PC**   
PH1, PH2
- C08S-PZ 2 PC**   
PZ1, PZ2
- C08S-S 3 PC**   
4.0, 5.5, 6.5 mm
- C11-12**
- C11-70 3 PC**   
75, 150, 250 mm
- C11-80**
- C11-91**   
F:3/8" x M:1/4"
- C11-92S**   
F:3/8" x M:1/2"
- C12-H 12 PC**   
10, 11, 12, 13, 14, 15, 16, 17, 18, 19, 21, 22 mm
- C16 4 PC**   
E10, E11, E12, E14
- C21-12**
- C21-40**

- C21-70W 3 PC**   
50, 125, 250 mm
- C21-80**
- C21-91S**   
F:1/2" x M:3/8"
- C21-92**   
F:1/2" x M:3/4"
- C22-B 20 PC**   
10, 11, 12, 13, 14, 15, 16, 17, 18, 19, 20, 21, 22, 23, 24, 26, 27, 28, 30, 32 mm
- C26 4 PC**   
E16, E18, E20, E24
- C62-B 3 PC**   
32, 34, 36 mm
- C31-91**   
F:3/4" x M:1/2"
- C64W-H 2 PC**   
17, 19 mm
- CB/800 5 PC**   
T5, T6, T7, T8, T9
- CB/800T 7 PC**   
T10, T15, T20, T25, T27, T30, T40
- BT/8001**   
1/4" - 1/4"



7. DRAWER

**3. DRAWER**



**B05 6 PC**  
8, 10, 12, 13, 17, 19 mm



**B19-1011**  
10x11



**C285-H 9 PC**   
5, 6, 7, 8, 10, 12, 14, 17, 19 mm



**C285-HBXL 4 PC**   
6, 7, 8, 10 mm



**C285-X 7 PC**   
M5, M6, M8, M10, M12, M14, M16



**C68-X18**   
M18



**C285-XL 2 PC**   
M8, M14



**C285-XXL 2 PC**   
M10, M12



**C285-T 8 PC**   
T25, T27, T30, T40, T45, T50, T55, T60

**4. DRAWER**



**F10 4 PC**   
3, 4, 5.5, 6.5 mm



**F14 2 PC**   
PH1, PH2



**F13-055-025**   
5.5 x 25 mm



**F16-002-025**   
PH2 x 25 mm



**F26/RDS 12 in 1**



**F26/BT**



**CB/ST31 31 PC**



**F26/BR2**



**6105CP**   
3 mm

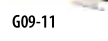

**G09-11**

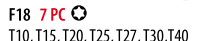

**F18 7 PC**   
T10, T15, T20, T25, T27, T30, T40



**LT/900 9 PC**   
1.5, 2, 2.5, 3, 4, 5, 6, 8, 10 mm



**LT/700L 8 PC**   
T9, T10, T15, T20, T25, T27, T30, T40

**5. DRAWER**



**E01-41-0180**  
180 mm



**E06-41-0160**  
160 mm



**E15-41-0200**  
200 mm



**E16-41-0200**  
200 mm



**E30-54-0250**  
250 mm



**E50-240-2**  
240 mm



**E65-44-0180**  
19-60 mm



**E66-44-0180**  
19-60 mm



**E67-44-0180**  
19-60 mm



**E68-44-0180**  
19-60 mm

**6. DRAWER**



**F20 4 PC**   
7, 8, 10, 13 mm



**J45CPM**  
18 mm



**J45-R 10 PC**  
18 mm



**L01-500**  
500 mm



**L12-40**  
Ø 40 mm



**L12-R40**  
Ø 40 mm

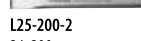

**L25-200-2**  
24x200 mm



**L29-4**  
4 mm



**L31 4 PC**  
3, 4, 5, 6 mm



**N21-10**



**N31-12**



**P05-0519**  
5M x 19 mm

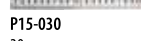

**P15-030**  
30 cm



**P54-20S**  
Metric - 20 Blade



**R11-PEN**  
100 Lumens



**R15-1000**  
1000 gr



**R36-1**



**R36-2**



**R36-3**



**R36-4**



**R37-25**

**7. DRAWER**



**B01 3 PC**  
27, 30, 32 mm



**B14 2 PC**  
24x27, 30x32 mm



**C21-79W**   
500 mm



**C31-40**



**N23-0750**  
500 mm

**319 Piece Tool Kit**

Contents Only



CODE NO **A50MB-319**

**319 Piece Tool Kits in Roller Cabinets**

(A50MB-319+A01M-08)

(A50MB-319+A01-08)



**GT MAX**  
8 DRAWER



**GT PLUS**  
8 DRAWER

**A50MB-319A01M**

**A50MB-319A01**

# 01 Tool Containers and Assortments

Automotive Tool Set

## BMW

**new**

# 321 PIECE

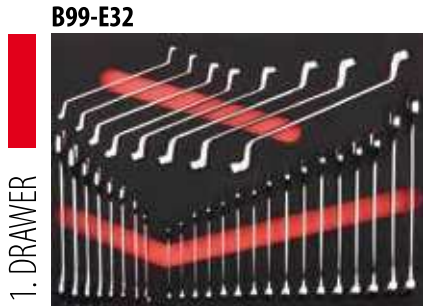

1. DRAWER

**1. DRAWER**

**B01 16 PC**  
6, 7, 8, 9, 10, 11, 12, 13, 14, 15, 16, 17, 18, 19, 22, 24 mm

**B09 8 PC**  
6x7, 8x9, 10x11, 12x13, 14x15, 16x17, 18x19, 20x22 mm

**B14 8 PC**  
6x7, 8x9, 10x11, 12x13, 14x15, 16x17, 18x19, 20x22 mm



2. DRAWER

**2. DRAWER**

**C01-12**  $\frac{1}{2}$ "

**C01-20**  $\frac{1}{2}$ "

**C01-40**  $\frac{1}{2}$ "

**C01-70 2 PC**  $\frac{1}{2}$ "  
50 mm, 150 mm

**C01-80**  $\frac{1}{2}$ "

**C01-92**  $\frac{1}{2}$ "  
F:1/4" x M:3/8 mm

**C02-H 12 PC**  $\frac{1}{2}$ "  $\frac{1}{2}$ "  
4, 5, 5.5, 6, 7, 8, 9, 10, 11, 12, 13, 14 mm

**C04-H 11 PC**  $\frac{1}{2}$ "  $\frac{1}{2}$ "  
4, 5, 5.5, 6, 7, 8, 9, 10, 11, 12, 13 mm

**C08S-H 5 PC**  $\frac{1}{2}$ "  $\frac{1}{2}$ "  
3, 4, 5, 6, 8 mm



3. DRAWER



4. DRAWER









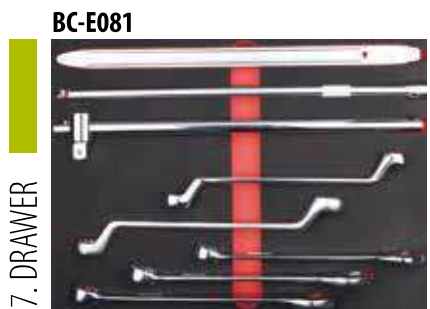
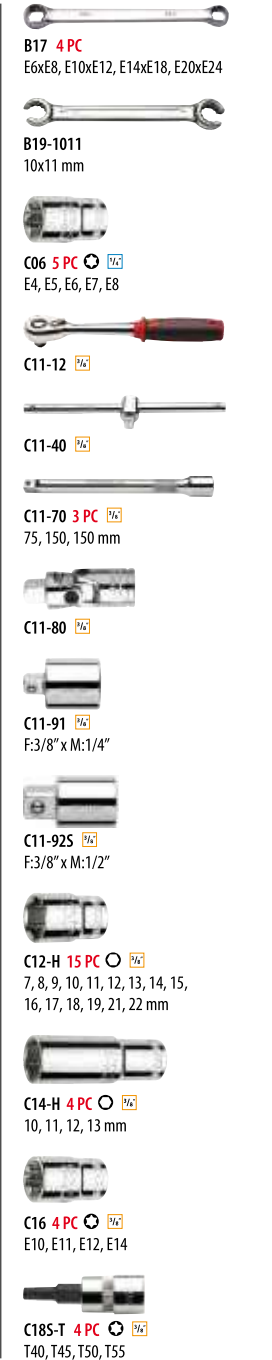
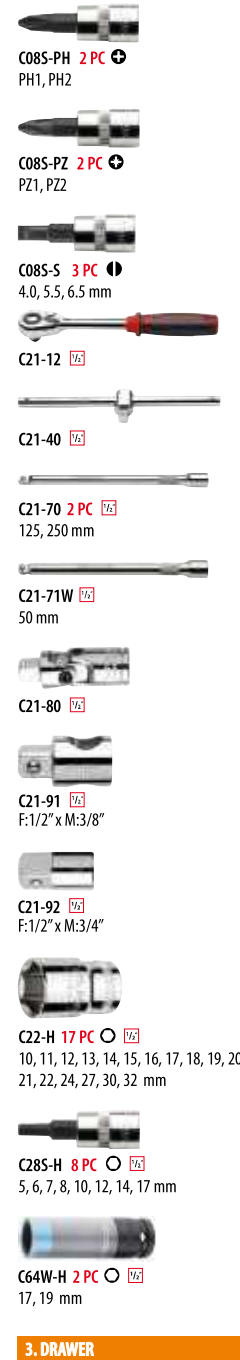

5. DRAWER



6. DRAWER

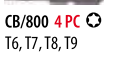
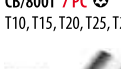
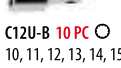

7. DRAWER

-  **C185-H09** 9 mm
-  **C26 4 PC** E16, E18, E20, E24 mm
-  **C285-T 3 PC** T50, T55, T60
-  **BT/8001** 1/4" - 1/4"
-  **BT/8005** 3/8" - H10
-  **CB/3000G 3 PC** M6, M8, M10 mm
-  **CB/800 4 PC** T6, T7, T8, T9
-  **CB/800T 7 PC** T10, T15, T20, T25, T27, T30, T40
-  **C12U-B 10 PC** 10, 11, 12, 13, 14, 15, 16, 17, 18, 19 mm
- 4. DRAWER**
-  **F10 4 PC** 3, 4, 5.5, 6.5 mm
-  **F14 2 PC** PH1, PH2

-  **F13-055-025** 5.5 x 25 mm
-  **F16-002-025** PH2 x 25 mm
-  **F26/RDS 12 in 1**
-  **F26/BT**
-  **CB/ST31 31 PC**
-  **F26/BR2**
-  **6105CP** 3 mm
-  **G09-11**
-  **F18 7 PC** T10, T15, T20, T25, T27, T30, T40
-  **LT/900 9 PC** 1.5, 2, 2.5, 3, 4, 5, 6, 8, 10 mm
-  **LT/700L 8 PC** T9, T10, T15, T20, T25, T27, T30, T40

- 5. DRAWER**
-  **E01-41-0180** 180 mm
-  **E06-41-0160** 160 mm
-  **E15-41-0200** 200 mm
-  **E16-41-0200** 200 mm
-  **E30-54-0250** 250 mm
-  **E50-240-2** 240 mm
-  **E65-44-0180** 19-60 mm
-  **E66-44-0180** 19-60 mm
-  **E67-44-0180** 19-60 mm
-  **E68-44-0180** 19-60 mm

- 6. DRAWER**
-  **F20 4 PC** 7, 8, 10, 13 mm
-  **J45CPM** 18 mm
-  **J45-R 10 PC** 18 mm
-  **L01-500** 500 mm
-  **L12-40** Ø 40 mm
-  **L12-R40** Ø 40 mm
-  **L25-200-2** 24x200 mm
-  **L29-4** 4 mm
-  **L31 4 PC** 3, 4, 5, 6 mm
-  **N21-10**
-  **N31-12**
-  **P05-0519** 5M x 19 mm

-  **P15-030** 30 cm
-  **P54-20S** Metric - 20 Blade
-  **R11-PEN** 100 Lumens
-  **R15-1000** 1000 gr
-  **R36-1**
-  **R36-2**
-  **R36-3**
-  **R36-4**
-  **R37-25**
- 7. DRAWER**
-  **B01 3 PC** 27, 30, 32 mm
-  **B14 2 PC** 21x23, 24x26 mm
-  **C21-79W** 500 mm
-  **C31-40**
-  **N23-0750** 500 mm

321 Piece Tool Kit

Contents Only



CODE NO **A50BMW-321**

321 Piece Tool Kits in Roller Cabinets

(A50BMW-321+A01M-08)

(A50BMW-321+A01-08)



**GT MAX**  
8 DRAWER



**GT PLUS**  
8 DRAWER

**A50BMW-321A01M**

**A50BMW-321A01**

# 01 Tool Containers and Assortments

Automotive Tool Set

## BODY REPAIR

**new**

**153 PIECE**

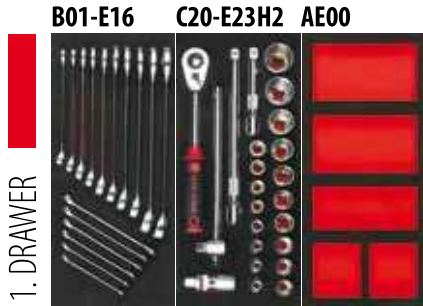

1. DRAWER

**1. DRAWER**

**B01 16 PC**  
6, 7, 8, 9, 10, 11, 12, 13, 14, 15, 16, 17, 18, 19, 22, 24 mm

**C22-H 18 PC**  
8, 10, 11, 12, 13, 14, 15, 16, 17, 18, 19, 20, 21, 22, 24, 27, 30, 32 mm

**C21-12**

**C21-40**

**C21-70 2 PC**  
125 mm, 250 mm

**C21-80**

**2. DRAWER**

**F10 4 PC**  
3, 4, 5.5, 6.5 mm

**F14 2 PC**  
PH1, PH2

**LT/900 9 PC**  
1.5, 2, 2.5, 3, 4, 5, 6, 8, 10 mm

**CB/ST31 31 PC**

**6105CP**  
3 mm

**E01-41-0180**  
180 mm

**E06-41-0160**  
160 mm

**E15-41-0160**  
160 mm

**E30-54-0250**  
250 mm

**J45C**  
18 mm

**J45-R 10 PC**  
18 mm

**L01-500**  
500 mm

**L25-200-2**  
24x200 mm

**L29-4**  
4 mm

**L31 4 PC**  
3, 4, 5, 6 mm

**P05-0519**  
5M x 19 mm

**P15-030**  
30 cm

**P54-205**  
Metric - 20 Blade

**3. DRAWER**

**K20 6 PC**  
6, 7, 8, 10, 11, 13 mm

**E36-54-0225**  
225 mm

**E50-240-2**  
240 mm

**L01-300**  
300 mm

**L25-250G-2**  
28x250 mm



2. DRAWER



3. DRAWER

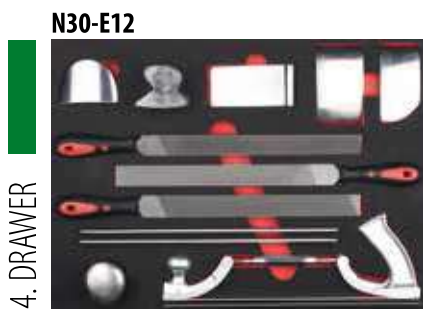

4. DRAWER

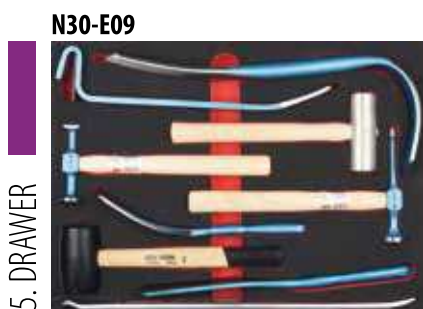

5. DRAWER



R40-4  
275 mm



R35DE  
235 mm



N31-1105 5 PC



N31-12



J04-250L  
250 mm (Left Cut)



J04-250R  
250 mm (Right Cut)



J81-200  
10 mm

**4. DRAWER**



N33-04  
370 mm



N33-04R1C  
350 mm



N33-04R1D  
350 mm



J55-H 3 PC  
300 mm Hand Files (Bastard, Second, Smooth)



CF.AD002  
Wedge Dolly (Flat)



CF.AD003  
Toe Dolly



CF.AD004  
Double End Dolly (Convex and Flat Head)



CF.AD007  
Anvil Dolly



CF.AD008  
Heel Dolly



CF.AD009  
Wedge Dolly (Convex)

**5. DRAWER**



N33-03DS  
Double Ended Spoon



N33-03SLC  
General Purpose Spoon



N33-03SS  
General Purpose Spoon - Short Form



N33-03BI  
Bending Iron



N33-01BMC2  
Bumping Hammer



N33-01BPF  
Bumping Hammer



L16-40  
Ø60 mm



L17-40  
Ø40 mm



N23-0750  
500 mm

**153 Piece Tool Kit**

Contents Only



CODE NO **A50BR-153**

**153 Piece Tool Kits in Roller Cabinets**

(A50BR-153+A01M-07)

(A50BR-153+A01-07)



**GT MAX**  
7 DRAWER



**GT PLUS**  
7 DRAWER

**A50BR-153A01M**

**A50BR-153A01**

# 01 Tool Containers and Assortments

Automotive Tool Set

## BODY REPAIR - ALUMINIUM

**new**

**84 PIECE**

**1. DRAWER**

**B01-E16 C20-E23H2 AE00**

**EJ-E07**

**E55-E07**

**E50-E16**

**N30-E10**

**N30-E05**

**2. DRAWER**

**3. DRAWER**

**4. DRAWER**

**5. DRAWER**

**6. DRAWER**

**1. DRAWER**

**B01 16 PC**  
6, 7, 8, 9, 10, 11, 12, 13, 14, 15, 16, 17, 18, 19, 22, 24 mm

**C22-H 18 PC**   
8, 10, 11, 12, 13, 14, 15, 16, 17, 18, 19, 20, 21, 22, 24, 27, 30, 32 mm

**C21-12**

**C21-40**

**C21-70 2 PC**   
125 mm, 250 mm

**C21-80**

**2. DRAWER**

**E01-41-0180** 180 mm

**E30-54-0300** 300 mm

**E36-54-0225** 225 mm

**J04-250L**  
250 mm (Left Cut)

**J04-250R**  
250 mm (Right Cut)

**3. DRAWER**

**N33-04** 370 mm

**L20-0401** 400 mm

**E55-2 2 PC**  
2x280 mm

**E55P-2 3 PC**  
2x180 mm, 300 mm

**L25-250G-2**  
28 x 250 mm

**R40-4** 275 mm

**4. DRAWER**

**E30-54-0250** 250 mm

**E50-2 3 PC**  
140, 190, 240 mm

**E50L-2 2 PC**  
170, 230 mm

**E51-2 2 PC**  
190, 240 mm

**E52-240-2** 240 mm

**E52S-240-2** 240 mm

**E56-J1** 210 mm

**E56-J2** 235 mm

**E56-L1** 195 mm

**E56-L2** 220 mm

**E56-W1** 195 mm

**J55-112H**  
300 mm Hand File (Bastard)

**5. DRAWER**

**N33-01BMC2**  
Bumping Hammer

**N33-01BPF**  
Bumping Hammer

**L17-40** Ø40 mm

**L12-30** Ø30 mm

**L12-R30** Ø30 mm

**L12DB-40** Ø40 mm

**L01-300** 300 mm

**CF.AD003** Toe Dolly

**CF.AD007** Anvil Dolly

**CF.AD0017** Wedge Dolly

**6. DRAWER**

**N33-03DS**  
Double Ended Spoon

**N33-03SLC**  
General Purpose Spoon

**N33-03SS**  
General Purpose Spoon-Short

**N33-03BI**  
Bending Iron

**N23-0750** 500 mm

### 84 Piece Tool Kit

Contents Only



CODE NO **A50BR-84**

### 84 Piece Tool Kits in Roller Cabinets

(A50BR-84+A01M-08)



**A50BR-84A01M**

(A50BR-84+A01-08)



**A50BR-84A01**

**GT MAX**  
8 DRAWER

**GT PLUS**  
8 DRAWER

## 205 PIECE

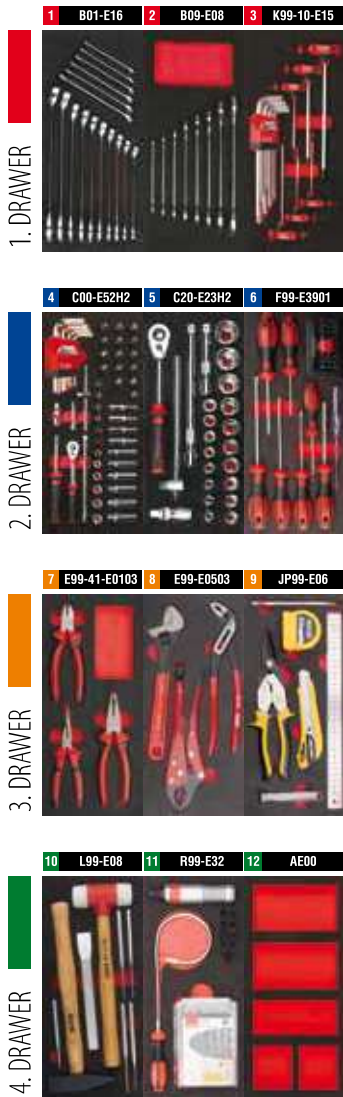

### 205 Piece Tool Kit

<b>A50TK-205</b>	Contents Only
<b>A50TK-205A01</b>	(A50TK-205+A01-06)
<b>A50TK-205A02</b>	(A50TK-205+A02-06)

## 241 PIECE

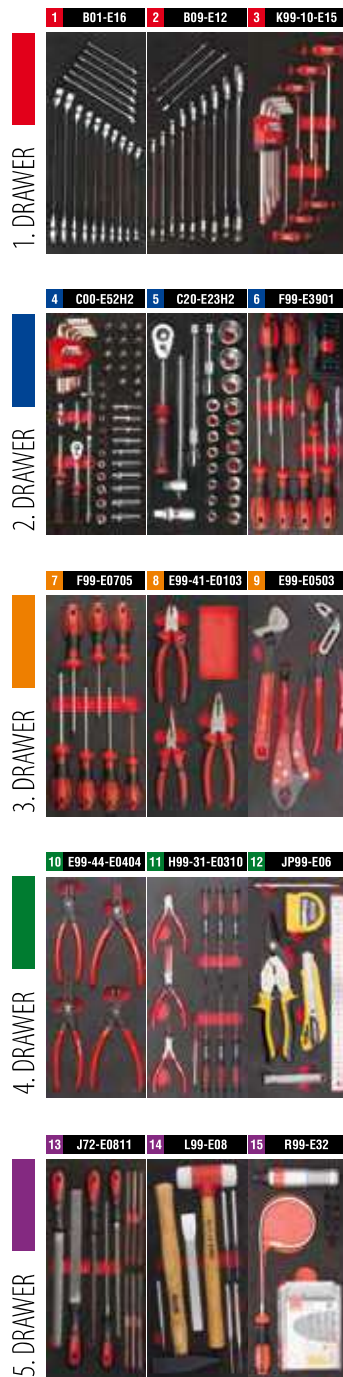

### 241 Piece Tool Kit

<b>A50TK-241</b>	Contents Only
<b>A50TK-241A01</b>	(A50TK-241+A01-07)
<b>A50TK-241A02</b>	(A50TK-241+A02-06)

## 304 PIECE

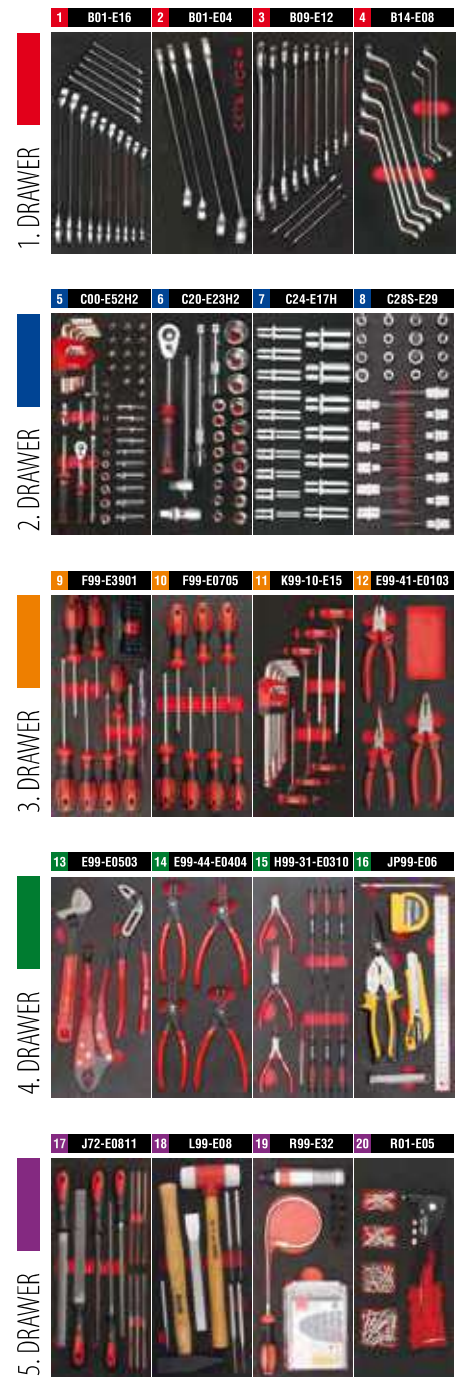

### 304 Piece Tool Kit

<b>A50TK-304</b>	Contents Only
<b>A50TK-304A01</b>	(A50TK-304+A01-07J)

# 01 Tool Containers and Assortments

Automotive Tool Set / Pre-2018

## 314 PIECE

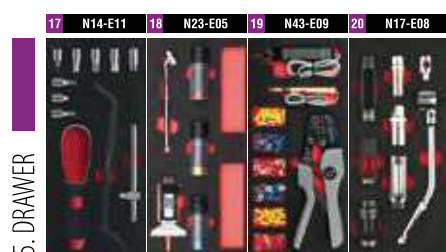
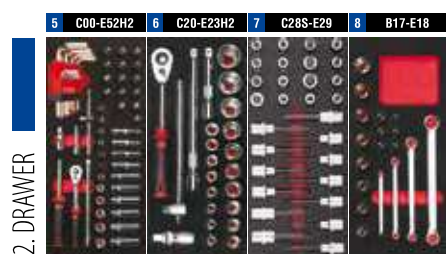
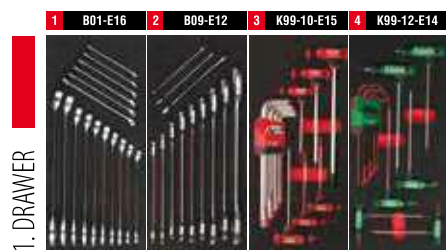

### 314 Piece Tool Kit

**A50CR-314** Contents Only

**A50CR-314A01** (A50CR-314+A01-07J)

# 2



## Wrenches and Hex Keys



# 02 Wrenches and Hex Keys

## CETA FORM Wrenches

Precise, Tough and Elegant

100%

### PRECISE

All Ceta Form wrenches are broached to very tight tolerances. In the later stages of production, necessary efforts are given to ensure that these original tolerances are kept. Therefore either open-end or ring, all wrenches tightly fit the fasteners.



### VERSATILE

From open-end to ring-end, E-TORX to flare nut, metric to imperial a large range of variants are available throughout our wrenches range. You will find what you are looking for.



### TOUGH

Only premium quality, crack-controlled steel is used during the forging. Coupled with the deep heat treatment know-how of Ceta Form, all Ceta Form wrenches are guaranteed to withstand against higher torques than the DIN.



Most Ceta Form wrench sets are offered in new high quality tetron pouches

## C GEAR Wrenches

Ideal for working in confined spaces, C-Gear wrenches enable the user to work on a nut/bolt without removing the tool to reposition it.



### B05 Series

The standard model. A compact ratchet spanner combined with an open-ended spanner.



### B06 Series

The flexible model. For even more confined spaces, the pivoting flexible ring end allows for 90° operation.

# Combination Wrenches



## B01 Series

Combination Wrenches

DIN 3113, ISO 7738



Ring end offset from shaft at 15°

CODE NO	mm	mm	
B01-05/2	5.5	104	12
B01-06	6	110	12
B01-07	7	110	12
B01-08	8	120	12
B01-09	9	130	12
B01-10	10	140	12
B01-11	11	150	12
B01-12	12	160	12
B01-13	13	170	12
B01-14	14	180	12
B01-15	15	190	12
B01-16	16	200	12
B01-17	17	210	12
B01-18	18	220	12
B01-19	19	230	12
B01-20	20	240	12
B01-21	21	250	12
B01-22	22	260	12
B01-23	23	270	6
B01-24	24	280	6
B01-25	25	290	6
B01-26	26	300	6
B01-27	27	310	6
B01-28	28	320	6
B01-30	30	340	6
B01-32	32	360	6
B01-36	36	450	3
B01-38	38	465	3
B01-41	41	480	3
B01-46	46	490	1
B01-50	50	505	1
 For display carded delivery = Item code + X			6
 Not available for sizes bigger than 32 mm			

## B01-R Series

Combination Wrench Sets (in Roll Pouch)

**new**  
design



CODE NO		
B01-R12		1
<b>12 PC:</b> 8, 9, 10, 11, 12, 13, 14, 15, 16, 17, 19, 22 mm		
B01-R13		1
<b>13 PC:</b> 8, 9, 10, 11, 12, 13, 14, 15, 16, 17, 19, 21, 24 mm		
B01-R21		1
<b>21 PC:</b> 6, 7, 8, 9, 10, 11, 12, 13, 14, 15, 16, 17, 18, 19, 20, 21, 22, 24, 27, 30, 32 mm		

## B01-B Series

Combination Wrench Sets (in Carton Box)



CODE NO	
B01-B08	1
<b>8 PC:</b> 8, 10, 11, 12, 13, 14, 17, 19 mm	
B01-B12	1
<b>12 PC:</b> 8, 9, 10, 11, 12, 13, 14, 15, 16, 17, 19, 22 mm	
B01-B12/2	1
<b>12 PC:</b> 6, 7, 8, 9, 10, 11, 12, 13, 14, 17, 19, 22 mm	
B01-B17	1
<b>17 PC:</b> 6, 7, 8, 9, 10, 11, 12, 13, 14, 15, 16, 17, 18, 19, 20, 21, 22 mm	
B01-B21	1
<b>21 PC:</b> 6, 7, 8, 9, 10, 11, 12, 13, 14, 15, 16, 17, 18, 19, 20, 21, 22, 24, 27, 30, 32 mm	
B01-B25	1
<b>25 PC:</b> 6, 7, 8, 9, 10, 11, 12, 13, 14, 15, 16, 17, 18, 19, 20, 21, 22, 23, 24, 25, 26, 27, 28, 30, 32 mm	

## B01-P12

12 Piece Combination Wrench Set (in Plastic Holder)



CODE NO	
B01-P12	1
<b>12 PC:</b> 8, 9, 10, 11, 12, 13, 14, 15, 16, 17, 19, 22 mm	

## B01AS Series

Combination Wrenches (Short) - SAE

**new**



Ring end offset from shaft at 15°

CODE NO	inch	RING END	mm	
B01AS-00108	1/8	6-Point	77	6
B01AS-00532	5/32	6-Point	77	6
B01AS-00316	3/16	6-Point	82	6
B01AS-00732	7/32	6-Point	82	6
B01AS-00732B	7/32	12-Point	82	6

## B01A Series

Combination Wrenches - SAE



Ring end offset from shaft at 15°

CODE NO	inch	mm	
B01A-00104	1/4	104	6
<b>B01A-00932</b>	<b>9/32</b>	<b>113</b>	<b>6</b>
B01A-00516	5/16	125	6
<b>B01A-01132</b>	<b>11/32</b>	<b>134</b>	<b>6</b>
B01A-00308	3/8	142	6
B01A-00716	7/16	155	6
B01A-00102	1/2	174	6
B01A-00916	9/16	182	6
B01A-00508	5/8	205	6
B01A-01116	11/16	210	6
B01A-00304	3/4	230	6
B01A-01316	13/16	250	6
B01A-00708	7/8	260	6
B01A-01516	15/16	282	6
B01A-10000	1	290	6
B01A-10116	1 - 1/16	310	6
B01A-10108	1 - 1/8	320	6
B01A-10104	1 - 1/4	364	6
 For display carded delivery = Item code + X			6

## B01A-R Series

Combination Wrench Sets - SAE

**new**



CODE NO		
B01A-R09		1
<b>9 PC:</b> 1/4, 5/16, 3/8, 7/16, 1/2, 9/16, 5/8, 11/16, 3/4 inch		
B01A-R14		1
<b>14 PC:</b> 1/4, 5/16, 11/32, 3/8, 7/16, 1/2, 9/16, 5/8, 11/16, 3/4, 13/16, 7/8, 15/16, 1 inch		
B01A-R16		1
<b>16 PC:</b> 1/4, 5/16, 3/8, 7/16, 1/2, 9/16, 5/8, 11/16, 3/4, 13/16, 7/8, 15/16, 1, 1-1/16, 1-1/8, 1-1/4 inch		

# 02 Wrenches and Hex Keys

## C-GEAR Ratcheting Combination Wrenches

### B05 Series

C-GEAR Ratcheting Combination Wrenches (Straight)





Ratcheting ring end, flat pattern

CODE NO	mm	mm	
B05-08	8	136	6
B05-09	9	143	6
B05-10	10	160	6
B05-11	11	168	6
B05-12	12	174	6
B05-13	13	180	6
B05-14	14	193	6
B05-15	15	200	6
B05-16	16	216	6
B05-17	17	233	6
B05-18	18	239	6
B05-19	19	250	6
B05-21	21	285	6
B05-22	22	285	6
B05-24	24	325	6
B05-27	27	354	3
B05-30	30	425	3
B05-32	32	425	3
B05-36	36	482	2
 For display carded delivery = Item code + X			6
Not available for sizes bigger than 24 mm			

### B05-P12

12 Piece C-GEAR Ratcheting Combination Wrench Set



CODE NO	
B05-P12	1
 B05 8, 10, 11, 12, 13, 14, 17, 19 mm	 B05-14S 1/4"-10 mm B05-38S 3/8"-13 mm B05-12S 1/2"-19 mm
 B05-14B 1/4"-10 mm	

### B05R Series

C-GEAR Ratcheting Combination Wrenches (Quick Jaw/Reversible)



Ratcheting ring end offset from the shaft at 15° (reversible), unique ratcheting open end

CODE NO	mm	mm	
B05R-09	9	160	6
B05R-10	10	160	6
B05R-11	11	165	6
B05R-12	12	170	6
B05R-14	14	190	6
B05R-15	15	200	6
B05R-16	16	205	6
B05R-18	18	235	6

### B05-R Series

C-GEAR Ratcheting Combination Wrench Sets (Straight)

**new**



CODE NO	
B05-R05	1
<b>5 PC:</b> 8, 10, 13, 17, 19 mm	
B05-R12	1
<b>12 PC:</b> 8, 9, 10, 11, 12, 13, 14, 15, 16, 17, 18, 19 mm	

### B07-B01

4-in-1 C-GEAR Ratcheting Combination Wrench (Reversible)

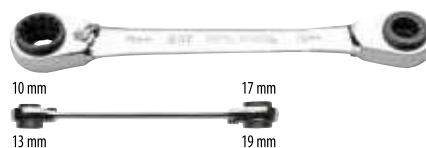

4 ratcheting rings, switch pawl

CODE NO	mm	mm	
B07-B01	10x13 - 17x19	230	10

### B06 Series

C-GEAR Ratcheting Combination Wrenches (Flex Head)



Ratcheting ring end (180° swiveling flex design)

CODE NO	mm	mm	
B06-08	8	135	6
B06-09	9	160	6
B06-10	10	160	6
B06-11	11	175	6
B06-12	12	175	6
B06-13	13	185	6
B06-14	14	195	6
B06-15	15	215	6
B06-16	16	215	6
B06-17	17	230	6
B06-18	18	250	6
B06-19	19	250	6
 For display carded delivery = Item code + X			6

### B06-R Series

Ratcheting Combination Wrench Sets (Flex Head)

**new**



CODE NO	
B06-R05	1
<b>5 PC:</b> 8, 10, 13, 17, 19 mm	
B06-R12	1
<b>12 PC:</b> 8, 9, 10, 11, 12, 13, 14, 15, 16, 17, 18, 19 mm	

## C-GEAR Adaptors

### B05-S Series

C-GEAR Socket Adaptors



Converts a C-GEAR combination wrench into a fine tooth ratchet, quick release function

CODE NO	inch	mm	Box
B05-14S	1/4	10	12
B05-38S	3/8	13	6
B05-12S	1/2	19	6

### B05-14B

C-GEAR Bit Adaptor



Converts a C-GEAR wrench into a 1/4" bit ratchet, spring loaded

CODE NO	inch	mm	Box
B05-14B	1/4	10	6

### B05-S04

4 Piece C-GEAR Adaptor Set



CODE NO	Box
B05-S04	10

4 PC: B05-14S, B05-38S, B05-12S, B05-14B

## Ratcheting Wrenches - SAE

### B07A Series

Ratcheting Ring Wrenches (Straight) - SAE



Ratcheting ring ends, switch lever

CODE NO	inch	mm	Box
B07A-0102	1/4x5/16	116	6
B07A-0203	5/16x11/32	136	6
B07A-0304	3/8x7/16	144	6
B07A-0506	1/2x9/16	177	6

### B07A-B04

4 Piece Ratcheting Ring Wrench Set (Straight) - SAE **new**



CODE NO	Box
B07A-B04	1

4 PC: 1/4x5/16, 5/16x11/32, 3/8x7/16, 1/2x9/16 inch

### B05AR Series

C-GEAR Ratcheting Combination Wrenches (Reversible) - SAE



Ratcheting ring end offset from the shaft at 15° (reversible)

CODE NO	inch	mm	Box
B05AR-0732	7/32	124	6
B05AR-0104	1/4	124	6
B05AR-0932	9/32	124	6
B05AR-0516	5/16	135	6
B05AR-1132	11/32	142	6
B05AR-0308	3/8	158	6
B05AR-0716	7/16	167	6
B05AR-0102	1/2	179	6
B05AR-0916	9/16	189	6
B05AR-0508	5/8	215	6
B05AR-1116	11/16	232	6
B05AR-0304	3/4	247	6

### B07A0 Series

Ratcheting Ring Wrenches (Offset) - SAE **new**



Ratcheting ring ends offset from the shaft, switch lever

CODE NO	inch	mm	Box
B07A0-0102	1/4 x5/16	112	6
B07A0-0203	5/16 x 11/32	130	6
B07A0-0304	3/8 x 7/16	138	6
B07A0-0506	1/2 x 9/16	172	6

### B07A0-B04

4 Piece Ratcheting Ring Wrench Set (Offset) - SAE **new**



CODE NO	Box
B07A0-B04	1

4 PC: 1/4x5/16, 5/16x11/32, 3/8x7/16, 1/2x9/16 inch

### B07C-2122

Scaffold Ratchet Wrench (Double Ended)



limited with stocks

For use on scaffolding bolts, 2 socket sizes in 1 wrench, switch lever

CODE NO	inch	mm	Box
B07C-2122	21x22	310	1

# 02 Wrenches and Hex Keys

## Double Open End Wrenches

### B09 Series

Double Open End Wrenches

DIN 3110, ISO 10102



Open ends offset from the shaft at 15°

CODE NO	mm	mm	
B09-0607	6x 7	120	12
B09-0809	8x 9	140	12
B09-0810	8x10	145	12
B09-1011	10x11	150	12
B09-1012	10x12	155	12
B09-1013	10x13	170	12
B09-1213	12x13	170	12
B09-1214	12x14	170	12
B09-1317	13x17	200	12
B09-1415	14x15	185	12
B09-1417	14x17	200	12
B09-1617	16x17	200	12
B09-1719	17x19	220	12
B09-1819	18x19	220	12
B09-1922	19x22	230	12
B09-2022	20x22	235	12
B09-2123	21x23	245	6
B09-2224	22x24	250	6
B09-2426	24x26	265	6
B09-2427	24x27	265	6
B09-2528	25x28	275	6
B09-2732	27x32	300	6
B09-3032	30x32	300	6
B09-3236	32x36	318	6
B09-3641	36x41	335	3
B09-4146	41x46	365	1
B09-4650	46x50	400	1

For display carded delivery = Item code + X  
Not available for sizes bigger than 30x32 mm

### B09-R Series

Double Open End Wrench Sets (in Roll Pouch)

new design



CODE NO		
B09-R08	1	
<b>8 PC:</b> 6x7, 8x9, 10x11, 12x13, 14x15, 16x17, 18x19, 20x22 mm		
B09-R12	1	
<b>12 PC:</b> 6x7, 8x9, 10x11, 12x13, 14x15, 16x17, 18x19, 20x22, 21x23, 24x26, 25x28, 30x32 mm		

### B09-B Series

Double Open End Wrench Sets (in Carton Box)



CODE NO		
B09-B06	1	
<b>6 PC:</b> 6x7, 8x9, 10x11, 12x13, 14x15, 16x17 mm		
B09-B08	1	
<b>8 PC:</b> 6x7, 8x9, 10x11, 12x13, 14x15, 16x17, 18x19, 20x22 mm		
B09-B10	1	
<b>10 PC:</b> 6x7, 8x9, 10x11, 12x13, 14x15, 16x17, 18x19, 20x22, 21x23, 24x26 mm		
B09-B10/2	1	
<b>10 PC:</b> 6x7, 8x9, 10x11, 12x13, 14x15, 16x17, 18x19, 20x22, 24x27, 30x32 mm		
B09-B12	1	
<b>12 PC:</b> 6x7, 8x9, 10x11, 12x13, 14x15, 16x17, 18x19, 20x22, 21x23, 24x26, 25x28, 30x32 mm		

### B09-P12

12 Piece Double Open End Wrench Set (in Plastic Holder)



CODE NO		
B09-P12	1	
<b>12 PC:</b> 6x7, 8x9, 10x11, 12x13, 14x15, 16x17, 18x19, 20x22, 21x23, 24x26, 25x28, 30x32 mm		

### B09SA Series

Short Angle Open End Wrenches - SAE

inch



Open ends offset from shaft at 15° and 75°

CODE NO	inch	mm	
B09SA-0732	7/32	75	6
B09SA-1564	15/64	80	6
B09SA-0104	1/4	80	6
B09SA-0932	9/32	80	6
B09SA-0516	5/16	90	6
B09SA-1132	11/32	90	6
B09SA-0308	3/8	100	6
B09SA-0716	7/16	100	6
B09SA-0102	1/2	120	6
B09SA-0916	9/16	120	6

### B09A Series

Double Open End Wrenches - SAE

inch



Open ends offset from the shaft at 15°

CODE NO	inch	mm	
B09A-0102	1/4x5/16	123	6
B09A-0203	5/16x3/8	142	6
B09A-0304	3/8x7/16	158	6
B09A-0405	7/16x1/2	171	6
B09A-0506	1/2x9/16	175	6
B09A-0607	9/16x5/8	187	6
B09A-0708	5/8x11/16	201	6
B09A-0709	5/8x3/4	201	6
B09A-0809	11/16x3/4	220	6
B09A-0911	3/4x7/8	237	6
B09A-1011	13/16x7/8	238	6
B09A-1213	15/16x1	265	6
B09A-1315	1x1-1/8	279	6
B09A-1415	1-1/16x1-1/8	300	6
B09A-1417	1-1/16x1-1/4	300	6

### B09A-R10

10 Piece Double Open End Wrench Set - SAE

new



inch

CODE NO		
B09A-R10	1	
<b>10 PC:</b> 1/4x5/16, 5/16x3/8, 7/16x1/2, 1/2x9/16, 9/16x5/8, 5/8x3/4, 11/16x3/4, 13/16x7/8, 15/16x1, 1-1/16x1-1/8 inch		

### B09SA-R09

9 Piece Short Angle Open End Wrench Set - SAE

new



inch

CODE NO		
B09SA-R09	1	
<b>9 PC:</b> 7/32, 15/64, 1/4, 9/32, 5/16, 11/32, 3/8, 7/16, 1/2 inch		

## Double Ring End Wrenches

### B14 Series

Double Ring End Wrenches

DIN 838, ISO 10104



75° deep offset ring ends

CODE NO	mm	mm	
B14-0607	6x 7	165	12
B14-0809	8x 9	180	12
B14-1011	10x11	195	12
B14-1213	12x13	215	12
B14-1415	14x15	230	12
B14-1617	16x17	250	12
B14-1819	18x19	265	12
B14-2022	20x22	285	12
B14-2123	21x23	305	6
B14-2426	24x26	325	6
B14-2427	24x27	325	6
B14-2528	25x28	341	6
B14-3032	30x32	376	6
B14-3641	36x41	443	6

### B14-R Series

Double Ring End Wrench Sets (in Roll Pouch)

**new**  
design



CODE NO	
B14-R08	1
<b>8 PC:</b> 6x7, 8x9, 10x11, 12x13, 14x15, 16x17, 18x19, 20x22 mm	
B14-R12	1
<b>12 PC:</b> 6x7, 8x9, 10x11, 12x13, 14x15, 16x17, 18x19, 20x22, 21x23, 24x26, 25x28, 30x32 mm	

### B14-B Series

Double Ring End Wrench Sets (in Carton Box)



CODE NO	
B14-B06	1
<b>6 PC:</b> 6x7, 8x9, 10x11, 12x13, 14x15, 16x17 mm	
B14-B08	1
<b>8 PC:</b> 6x7, 8x9, 10x11, 12x13, 14x15, 16x17, 18x19, 20x22 mm	
B14-B10/2	1
<b>10 PC:</b> 6x7, 8x9, 10x11, 12x13, 14x15, 16x17, 18x19, 20x22, 24x27, 30x32 mm	
B14-B12	1
<b>12 PC:</b> 6x7, 8x9, 10x11, 12x13, 14x15, 16x17, 18x19, 20x22, 21x23, 24x26, 25x28, 30x32 mm	

## Special Profile Wrenches

### B19 Series

Flare Nut Wrenches

DIN 3118, TS 3794-6



Ideal for unions on hydraulic/brake or water lines

**08x10-12x14: Hexagon**

**17x19-24x27: Bi-hexagon**



CODE NO	mm	mm	
B19-0810	8x10	141	6
B19-0911	9x11	151	6
B19-1011	10x11	161	6
B19-1113	11x13	175	6
B19-1214	12x14	175	6
B19-1719	17x19	210	6
B19-1922	19x22	230	6
B19-2427	24x27	295	6
For display carded delivery = Item code + X			6

### B19-B06

6 Piece Flare Nut Wrench Set



CODE NO	
B19-B06	1
<b>6 PC:</b> 8x10, 10x11, 11x13, 12x14, 17x19, 19x22 mm	

### B20 Series

Half Moon Ring Wrenches

ISO 3118



Ideal for tight spaces (starter motors, manifolds etc.)

CODE NO	mm	mm	
B20-1012	10x12	143	6
B20-1113	11x13	143	6
B20-1315	13x15	166	6
B20-1317	13x17	183	6
B20-1417	14x17	183	6
B20-1922	19x22	235	6

### B17 Series

E-TORX Ring Wrenches



For external TORX screws, flat pattern

CODE NO	mm	mm	
B17-0608	E06xE08	111	6
B17-1012	E10xE12	140	6
B17-1418	E14xE18	180	6
B17-2024	E20xE24	225	6
For display carded delivery = Item code + X			6

### B17-B04

4 Piece E-TORX Ring Wrench Set



CODE NO	
B17-B04	1
<b>4 PC:</b> E6xE8, E10xE12, E14xE18, E20xE24	

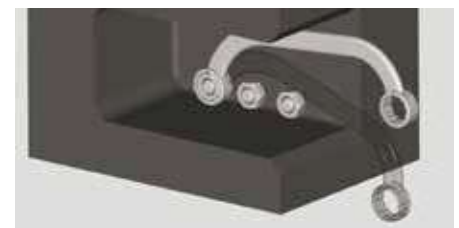

# 02 Wrenches and Hex Keys

## B21W Series New Adjustable Wrenches

Professional quality adjustable wrenches with extra wide jaw opening

### SLIM

The slim and tapering design of the jaws makes it very easy to access restricted areas. Thanks to the premium material selection, the jaws are still very durable despite compact dimensions.

### ERGONOMIC

The softgrip ergonomic handle allows for a good grip and ensures fatigue free working for long hours.

### EXTRA-WIDE

Extra-wide opening capacity makes it possible to work with a smaller tool for the same job. For instance the jaw capacity of this tool (200 mm long) is equal to that of a 300 mm long adjustable wrench.



200 mm - 8"



## B21 Series Adjustable Wrenches

- Adjustable jaw set at 15° for easy repositioning
- Ergonomic design for easy handling
- mm scaled
- High alloy tool steel
- PVC Sleeves



### B21-B Series

Adjustable Wrenches (Phosphated-PVC Grip)

DIN 3117, ISO 6787



CODE NO	mm "	mm	
B21-150B	150 - 6"	20	6
B21-200B	200 - 8"	25	6
B21-250B	250 - 10"	30	6
B21-300B	300 - 12"	35	6
B21-375B	375 - 15"	45	2

### B21-C Series

Adjustable Wrenches (Chromed-PVC Grip)

DIN 3117, ISO 6787



CODE NO	mm "	mm	
B21-150C	150 - 6"	20	6
B21-200C	200 - 8"	25	6
B21-250C	250 - 10"	30	6
B21-300C	300 - 12"	35	6
B21-375C	375 - 15"	45	2

### B21W-200B

Adjustable Wrench (Wide Opening Jaws)

DIN 3117, ISO 6787



Extra wide opening jaws, slim head dimensions for access to confined spaces

CODE NO	mm "	mm	
B21W-200B	200 - 8"	38	6

**new**

## Slogging Wrenches

### B23 Series

Open End Slogging Wrenches

DIN 133, TS 81



Ideal for fasteners on heavy equipment, for use with a hammer or sledge hammer

CODE NO	Ømm	mm	
B23-27	27	180	1
B23-30	30	190	1
B23-32	32	190	1
B23-36	36	210	1
B23-41	41	230	1
B23-46	46	250	1
B23-50	50	275	1
B23-55	55	305	1
B23-60	60	315	1
B23-65	65	335	1
B23-70	70	370	1
B23-75	75	395	1
B23-80	80	400	1
B23-85	85	400	1
B23-90	90	445	1
B23-95	95	445	1
B23-100	100	485	1

### B24 Series

Ring End Slogging Wrenches

DIN 7444, TS 3794



Ideal for fasteners on heavy equipment, for use with a hammer or sledge hammer

CODE NO	Ømm	mm	
B24-27	27	185	1
B24-30	30	185	1
B24-32	32	185	1
B24-36	36	205	1
B24-41	41	225	1
B24-46	46	235	1
B24-50	50	250	1
B24-55	55	265	1
B24-60	60	275	1
B24-65	65	305	1
B24-70	70	335	1
B24-75	75	335	1
B24-80	80	360	1
B24-85	85	365	1
B24-90	90	395	1
B24-95	95	395	1
B24-100	100	425	1

## Double Ended Box Wrenches

### B27T Series

Double Ended Box Wrenches (Tubular)

DIN 896-BTS 3793-3



Hollow shaft in tubular steel ideal for protruding bolts, hexagon sockets

Tommy bars to be ordered separately

CODE NO	Ømm	mm	
B27T-0607	6x 7	100	6
B27T-0809	8x 9	100	6
B27T-1011	10x11	115	6
B27T-1213	12x13	135	6
B27T-1415	14x15	135	6
B27T-1617	16x17	145	6
B27T-1819	18x19	150	6
B27T-2022	20x22	160	6
B27T-2123	21x23	160	6
B27T-2426	24x26	175	6
B27T-2528	25x28	190	6
B27T-3032	30x32	190	6

### B27T-B Series

Double Ended Box Wrench Sets (Tubular)



CODE NO	
B27T-B08	1
<b>8 PC:</b> 6x7, 8x9, 10x11, 12x13, 14x15, 16x17, 18x19, 20x22 mm	
B27T-B12	1
<b>12 PC:</b> 6x7, 8x9, 10x11, 12x13, 14x15, 16x17, 18x19, 20x22, 21x23, 24x26, 25x28, 30x32 mm	

### B27T-B Series

Tommy Bars (for B27T Series)



B27T-B Series



B27-2B

B27-2B particularly for use with B27T series

CODE NO	mm	mm	
B27T-06B	6 - 11	160	6
B27T-08B	12 - 15	180	6
B27T-10B	16 - 17	200	6
B27T-12B	18 - 22	250	6
B27T-14B	21 - 26	320	6
B27T-16B	25 - 32	400	6
B27-2B	16 - 22	210	6

### B27 Series

Double Ended Box Wrenches (Forged)



Heavy-duty hexagon shaft, ideal for long threaded bolts

Tommy bars to be ordered separately

CODE NO	Ømm	mm	
B27-2022	20x22	175	6
B27-2123	21x23	185	6
B27-2224	22x24	185	6
B27-2426	24x26	190	6
B27-2427	24x27	190	6
B27-2528	25x28	205	6
B27-3032	30x32	210	6

### B28 Series

Double Ended Offset Socket Wrenches

ISO 2236



Deep recess at one end (hexagon) and open end (bi-hexagon) at the other end

CODE NO	Ømm	mm	
B28-06	6	110	6
B28-07	7	110	6
B28-08	8	115	6
B28-09	9	115	6
B28-10	10	130	6
B28-11	11	140	6
B28-12	12	150	6
B28-13	13	155	6
B28-14	14	165	6
B28-15	15	170	6
B28-16	16	180	6
B28-17	17	190	6
B28-18	18	200	6
B28-19	19	210	6
B28-22	22	230	6

### B28-B08

8 Piece Double Ended Offset Socket Wrench Set



CODE NO	
B28-B08	1
<b>8 PC:</b> 8, 10, 11, 12, 13, 14, 17, 19 mm	

# 02 Wrenches and Hex Keys

T Handle Nut Drivers / Swivel Socket Wrenches

## T Handle Nut Drivers

Maximum power transmission, long reach



- Chrome Vanadium steel shaft, matt chrome finished
- 25 mm deep hexagon socket for long threaded bolts
- Softgrip T-Handle for maximum power transmission

### K20 Series T-Handle Nut Drivers



25 mm deep hexagon socket for long threaded bolts

CODE NO	mm	mm	mm
K20-06	6	230	6
K20-07	7	230	6
K20-08	8	230	6
K20-09	9	230	6
K20-10	10	230	6
K20-11	11	230	6
K20-12	12	230	6
K20-13	13	230	6

### K20-L Series T-Handle Nut Drivers (Long Shaft)



25 mm deep hexagon socket for long threaded bolts

CODE NO	mm	mm	mm
K20-08L	8	350	6
K20-10L	10	350	6
K20-13L	13	350	6

### B32 Series T-Handle Swivel Socket Wrenches



Swiveling hexagon socket,  $\geq 10$  mm with 3/8" drive female end

CODE NO	mm	mm	mm
B32-06	6	396	6
B32-07	7	396	6
B32-08	8	396	6
B32-09	9	395	6
B32-10	10	395	6
B32-11	11	395	6
B32-12	12	395	6
B32-13	13	500	6
B32-14	14	500	6
B32-15	15	500	6
B32-16	16	500	6
B32-17	17	500	6
B32-18	18	500	6
B32-19	19	500	6

### B30 Series Double Swivel End Socket Wrenches

**new**



Bi-hexagon sockets, 180° swiveling design

CODE NO	mm	mm	mm
B30-0810	8x10	185	6
B30-1011	10x11	200	6
B30-1213	12x13	220	6
B30-1415	14x15	242	6
B30-1617	16x17	255	6
B30-1819	18x19	275	6

### K20-B06 6 Piece T-Handle Nut Driver Set



CODE NO	mm
K20-B06	1

6 PC: 6, 7, 8, 10, 12, 13 mm

# Hex L Keys

## Ceta Form Hex and TORX L Keys

Comprehensive range of hex and TORX L keys in industrial quality to suit every application. Color coded clips for ease of selection.



### Metric Hex Keys

- Silicon Chrome Vanadium steel
- Matt chrome finish
- 0.7 mm to 32 mm

**Metric**



### TORX Keys

- Chrome Vanadium Moly. steel
- Black finish
- T5 to T50

**TORX**



### SAE Hex Keys

- Silicon Chrome Vanadium steel
- Gunmetal finish
- 0.028 to 3/4"

**SAE**

The individual keys can now be offered on plastic hangers, ideal for self service sales points. Simply add a letter "X" to the original code for display packed delivery. Available for L, 800 and 900 series.



## Softgrip T-Handle Hexagon and TORX Keys

- Chrome-Vanadium-Molybdenum steel
- Matt chrome plated blades  
SAE keys: Gunmetal finish
- High-torque softgrip handles
- For sizes bigger than 3mm, chamfered tips allow easy fitting into hex screws



### L Series / mm

Hexagon L Keys (Short Arm)  
DIN / ISO 2936



1.3-12 mm: Matt chrome finish,  
0.7, 0.9, 13-32 mm: Phosphate finish

CODE NO	mm	mm	mm	
L/0028	0.7	0.028	35	12 •
L/0035	0.9	0.035	35	12 •
L/1.3	1.3	-	41	12 •
L/1.5	1.5	-	46	12 •
L/2	2	-	52	12 •
L/2.5	2.5	-	58	12 •
L/3	3	-	66	12 •
L/3.5	3.5	-	69	12 •
L/4	4	-	74	12 •
L/4.5	4.5	-	77	12 •
L/5	5	-	85	12 •
L/6	6	-	96	12 •
L/7	7	-	102	12 •
L/8	8	-	106	12 •
L/9	9	-	111	12 •
L/10	10	-	122	12 •
L/11	11	-	125	12 •
L/12	12	-	137	12 •
L/13	13	-	145	12
L/14	14	-	154	12
L/16	16	-	168	12
L/17	17	-	173	6
L/19	19	-	194	6
L/22	22	-	218	3
L/24	24	-	248	3
L/27	27	-	277	1
L/32	32	-	315	1
				6

For display carded delivery = Item code + X  
Available for sizes between 1.3 - 10 mm

### LB Series

Hexagon L Keys (Short Arm-Black)  
DIN / ISO 2936



CODE NO	mm	mm	
L/2.5B	2.5	58	100 •
L/3B	3	65	100 •

# 02 Wrenches and Hex Keys

## Hex L Keys

**LT/7**  
7 Piece Hexagon L Key Set (Short Arm)



CODE NO	
LT/7	6
<b>7 PC:</b> 1.5, 2, 2.5, 3, 4, 5, 6 mm	

**LT/9**  
9 Piece Hexagon L Key Set (Short Arm)



CODE NO	
LT/9	6
<b>9 PC:</b> 1.5, 2, 2.5, 3, 4, 5, 6, 8, 10 mm	

**LT/12**  
12 Piece Hexagon L Key Set (Short Arm)



CODE NO	
LT/12	6
<b>12 PC:</b> 1.5, 2, 2.5, 3, 3.5, 4, 5, 6, 7, 8, 10, 12 mm	

**LT/9D**  
LT/9 Hexagon L Key Set Display Pack



CODE NO	
LT/9D	1
<b>12x</b> LT/9	

**LT/12D**  
LT/12 Hexagon L Key Set Display Pack



CODE NO	
LT/12D	1
<b>12x</b> LT/12	

**800 Series**  
Hexagon L Keys (Long Arm)  
DIN / ISO 2936



CODE NO			
815	1.5	91	12 •
802	2	102	12 •
825	2.5	114	12 •
803	3	129	12 •
835	3.5	140	12 •
804	4	144	12 •
805	5	165	12 •
806	6	186	12 •
807	7	195	12 •
808	8	204	12 •
810	10	230	12 •
812	12	262	12 •
	For display carded delivery = Item code + X		6
Available for sizes between 1.5 - 10 mm			

**LT7/800**  
7 Piece Hexagon L Key Set (Long Arm)



CODE NO	
LT7/800	6
<b>7 PC:</b> 1.5, 2, 2.5, 3, 4, 5, 6 mm	

**LT/800**  
9 Piece Hexagon L Key Set (Long Arm)



CODE NO	
LT/800	6
<b>9 PC:</b> 1.5, 2, 2.5, 3, 4, 5, 6, 8, 10 mm	

**LT/800D**  
LT/800 Hexagon L Key Set Display Pack



CODE NO	
LT/800D	1
<b>12x</b> LT/800	

**LT12/800**  
12 Piece Hexagon L Key Set (Long Arm) new



CODE NO	
LT12/800	6
<b>12 PC:</b> 1.5, 2, 2.5, 3, 3.5, 4, 5, 6, 7, 8, 10, 12 mm	

# Hex L Keys

## 900 Series

Ball End Hexagon L Keys (Long Arm)



Ball end allows up to 25° entry

CODE NO	mm	mm	mm
915	1.5	91	12 •
902	2	102	12 •
925	2.5	114	12 •
903	3	129	12 •
935	3.5	140	12 •
904	4	144	12 •
905	5	165	12 •
906	6	186	12 •
907	7	195	12 •
908	8	208	12 •
910	10	231	12 •
912	12	262	12 •
	For display carded delivery = Item code + X		6
	Available for sizes between 1.5 - 10 mm		

## LT7/900

7 Piece Ball End Hexagon L Key Set (Long Arm)



CODE NO	mm
LT7/900	6
7 PC: 1.5, 2, 2.5, 3, 4, 5, 6 mm	

## L Series / SAE

Hexagon L Keys (Short Arm) - SAE



CODE NO	inch	mm	mm
L/0028	0.028	0.7	35
L/0035	0.035	0.9	35
L/0364	3/64	-	38
L/0050	0.050	1.27	41
L/0116	1/16	-	47
L/0564	5/64	-	52
L/0332	3/32	-	58
L/0764	7/64	-	58
L/0108	1/8	-	66
L/0964	9/64	-	66
L/0532	5/32	-	71
L/0316	3/16	-	83
L/0732	7/32	-	88
L/0104	1/4	-	94
L/0516	5/16	-	105
L/0308	3/8	-	118
L/0716	7/16	-	130
L/0102	1/2	-	141
L/0916	9/16	-	150
L/0508	5/8	-	172
L/0304	3/4	-	179

## LT/900

9 Piece Ball End Hexagon L Key Set (Long Arm)



CODE NO	mm
LT/900	6
9 PC: 1.5, 2, 2.5, 3, 4, 5, 6, 8, 10 mm	

## LT/900D

LT/900 Ball End Hexagon L Key Set Display Pack



CODE NO	mm
LT/900D	1
12x LT/900	

## LT/9AF

9 Piece Hexagon L Key Set (Short Arm) - SAE



CODE NO	mm
LT/9AF	6
9 PC: 1/16, 5/64, 3/32, 1/8, 5/32, 3/16, 1/4, 5/16, 3/8 inch	

## LT/13AF

13 Piece Hexagon L Key Set (Short Arm) - SAE



CODE NO	mm
LT/13AF	6
13 PC: 0.05, 1/16, 5/64, 3/32, 7/64, 1/8, 9/64, 5/32, 3/16, 7/32, 1/4, 5/16, 3/8 inch	

## LT/900C

9 Piece Ball End Hexagon L Key Set (Long Arm-Color Coded)

new



CODE NO	mm
LT/900C	6
9 PC: 1.5, 2, 2.5, 3, 4, 5, 6, 8, 10 mm	

## LT12/900

12 Piece Ball End Hexagon L Key Set (Long Arm)

new



CODE NO	mm
LT12/900	6
12 PC: 1.5, 2, 2.5, 3, 3.5, 4, 5, 6, 7, 8, 10, 12 mm	

## LT/9CP

18 Piece Combo Hexagon L Key Set (Short Arm) - Metric/SAE



CODE NO	mm
LT/9CP	6
LT/9, LT/9AF	

# 02 Wrenches and Hex Keys

## Hex L Keys

### 800 Series / SAE

Hexagon L Keys (Long Arm) - SAE

**new**



CODE NO	$\frac{\text{inch}}{16}$	mm	
80050	0.05*	80	12 •
80116	1/16	92	12 •
80564	5/64	102	12 •
80332	3/32	114	12 •
80764	7/64	126	12 •
80108	1/8	129	12 •
80964	9/64	137	12 •
80532	5/32	144	12 •
80316	3/16	165	12 •
80732	7/32	183	12 •
80104	1/4	186	12 •
80516	5/16	205	12 •
80308	3/8	230	12 •

\*0.05 inch = 1.27 mm

### 900 Series / SAE

Ball End Hexagon L Keys (Long Arm) - SAE



CODE NO	$\frac{\text{inch}}{16}$	mm	
90050	0.05*	80	12 •
90116	1/16	92	12 •
90564	5/64	102	12 •
90332	3/32	114	12 •
90764	7/64	126	12 •
90108	1/8	129	12 •
90964	9/64	137	12 •
90532	5/32	144	12 •
90316	3/16	165	12 •
90732	7/32	183	12 •
90104	1/4	186	12 •
90516	5/16	205	12 •
90308	3/8	230	12 •

\*0.05 inch = 1.27 mm

### LT/800AF

9 Piece Hexagon L Key Set (Long Arm) - SAE

**new**



CODE NO	
LT/800AF	6

9 PC: 1/16, 5/64, 3/32, 1/8, 5/32, 3/16, 1/4, 5/16, 3/8 inch

### LT13/800AF

13 Piece Hexagon L Key Set (Long Arm) - SAE

**new**



CODE NO	
LT13/800AF	6

13 PC: 0.05, 1/16, 5/64, 3/32, 7/64, 1/8, 9/64, 5/32, 3/16, 7/32, 1/4, 5/16, 3/8 inch

### LT/900AF

9 Piece Ball End Hexagon L Key Set (Long Arm) - SAE



CODE NO	
LT/900AF	6

9 PC: 1/16, 5/64, 3/32, 1/8, 5/32, 3/16, 1/4, 5/16, 3/8 inch

### LT13/900AF

13 Piece Ball End Hexagon L Key Set (Long Arm) - SAE

**new**



CODE NO	
LT13/900AF	6

13 PC: 0.05, 1/16, 5/64, 3/32, 7/64, 1/8, 9/64, 5/32, 3/16, 7/32, 1/4, 5/16, 3/8 inch

### LT/800CP

18 Piece Combo Hexagon L Key Set (Long Arm) - Metric/SAE

**new**



CODE NO	
LT/800CP	6
LT/800, LT/800AF	

### LT/900CP

18 Piece Combo Ball End Hexagon L Key Set (Long Arm) - Metric/SAE



CODE NO	
LT/900CP	6
LT/900, LT/900AF	

## Combo Hex L Key Sets

### LT27/800CP

27 Piece Combo Hexagon L Key Set (Long Arm)  
- Metric/SAE

**new**



CODE NO		
LT27/800CP		1
800/Metric 12 PC: 1.5, 2, 2.5, 3, 3.5, 4, 5, 6, 7, 8, 10, 12 mm		
800/SAE 12 PC: 1/16, 5/64, 3/32, 7/64, 1/8, 9/64, 5/32, 3/16, 7/32, 1/4, 5/16, 3/8 inch		
L/SAE 3 PC: 0.028, 0.035, 0.050 inch		

### LT27/900CP

27 Piece Combo Ball End Hexagon L Key Set (Long Arm) - Metric/SAE

**new**



CODE NO		
LT27/900CP		1
900/Metric 12 PC: 1.5, 2, 2.5, 3, 3.5, 4, 5, 6, 7, 8, 10, 12 mm		
900/SAE 12 PC: 1/16, 5/64, 3/32, 7/64, 1/8, 9/64, 5/32, 3/16, 7/32, 1/4, 5/16, 3/8 inch		
L/SAE 3 PC: 0.028, 0.035, 0.050 inch		

### K10T Series

T Hexagon Keys (3 Ways)



With 3 same sized hexagon ends

CODE NO			
K10T-030	3	155	12
K10T-040	4	175	12
K10T-050	5	195	12
K10T-060	6	215	12

## T Handle Hex Keys

### K10 Series

T-Handle Hexagon Keys



CODE NO			
K10-020-100	2	100	12
K10-025-100	2.5	100	12
K10-030-100	3	100	12
K10-040-150	4	150	12
K10-050-150	5	150	12
K10-060-200	6	200	12
K10-070-200	7	200	12
K10-080-200	8	200	12
K10-100-200	10	200	12

### K99-10-06

6 Piece T-Handle Hexagon Key Set (in Color Box)



CODE NO		
K99-10-06		1
6 PC: 2.5, 3, 4, 5, 6, 8 mm		

### K99-10-M08

8 Piece T Handle Hexagon Key Set (on Metal Stand)

**new**



CODE NO		
K99-10-M08		1
8 PC: 2, 2.5, 3, 4, 5, 6, 8, 10 mm		
K99-10-ME	Empty Metal Stand (for K10 series)	1

### K11 Series

T-Handle Ball End Hexagon Keys



Ball end allows up to 25° entry

CODE NO			
K11-020-100	2	100	12
K11-025-100	2.5	100	12
K11-030-100	3	100	12
K11-040-150	4	150	12
K11-050-150	5	150	12
K11-060-200	6	200	12
K11-080-200	8	200	12
K11-100-200	10	200	12

### K10A Series

T-Handle Hexagon Keys - SAE



CODE NO			
K10A-0564	5/64	100	12
K10A-0332	3/32	100	12
K10A-0764	7/64	100	12
K10A-0108	1/8	100	12
K10A-0964	9/64	100	12
K10A-0532	5/32	150	12
K10A-0316	3/16	150	12
K10A-0732	7/32	150	12
K10A-0104	1/4	200	12
K10A-0516	5/16	200	12
K10A-0308	3/8	200	12

### K99-10A-M10

10 Piece T Handle Hexagon Key Set (on Metal Stand) - SAE

**new**



CODE NO		
K99-10A-M10		1
10 PC: 3/32, 7/64, 1/8, 9/64, 5/32, 3/16, 7/32, 1/4, 5/16, 3/8 inch		
K99-10A-ME	Empty Metal Stand (for K10A series)	1

# 02 Wrenches and Hex Keys

## TORX L Keys

### 700 Series

TORX L Keys (Short Arm)



CODE NO		mm	
705	T5	40	12 •
706	T6	45	12 •
707	T7	50	12 •
708	T8	50	12 •
709	T9	50	12 •
710	T10	54	12 •
715	T15	57	12 •
720	T20	61	12 •
725	T25	64	12 •
727	T27	69	12 •
730	T30	76	12 •
740	T40	83	12 •
745	T45	86	12 •
750	T50	104	12 •

### LT/700

8 Piece TORX L Key Set (Short Arm)



CODE NO	
LT/700	6

8 PC: T9, T10, T15, T20, T25, T27, T30, T40

### LT13/700

13 Piece TORX L Key Set (Short Arm)



CODE NO	
LT13/700	6

13 PC: T5, T6, T7, T8, T9, T10, T15, T20, T25, T27, T30, T40, T45

### 700L Series

TORX L Keys (Long Arm)



CODE NO		mm	
705L	T5	78	12 •
706L	T6	80	12 •
707L	T7	83	12 •
708L	T8	86	12 •
709L	T9	89	12 •
710L	T10	93	12 •
715L	T15	103	12 •
720L	T20	113	12 •
725L	T25	126	12 •
727L	T27	145	12 •
730L	T30	166	12 •
740L	T40	180	12 •
745L	T45	200	12 •

### LT/700L

8 Piece TORX L Key Set (Long Arm)



CODE NO	
LT/700L	6

8 PC: T9, T10, T15, T20, T25, T27, T30, T40

### LT13/700L

13 Piece TORX L Key Set (Long Arm)



CODE NO	
LT13/700L	6

13 PC: T5, T6, T7, T8, T9, T10, T15, T20, T25, T27, T30, T40, T45

### 700TL Series

TORX Tamper Proof L Keys (Long Arm)

**new**



CODE NO		mm	
709TL	T9	89	12 •
710TL	T10	93	12 •
715TL	T15	103	12 •
720TL	T20	113	12 •
725TL	T25	126	12 •
727TL	T27	145	12 •
730TL	T30	166	12 •
740TL	T40	180	12 •

### LT/700TL

8 Piece TORX Tamper Proof L Key Set (Long Arm)

**new**



CODE NO	
LT/700TL	6

8 PC: T9, T10, T15, T20, T25, T27, T30, T40

## TORX L Keys

### 700B Series

Ball End TORX L Keys (Long Arm)



Ball end allows up to 25° entry

CODE NO			
709B	T9	89	12 •
710B	T10	93	12 •
715B	T15	103	12 •
720B	T20	116	12 •
725B	T25	128	12 •
727B	T27	145	12 •
730B	T30	166	12 •
740B	T40	187	12 •

### LT/700B

8 Piece Ball End TORX L Key Set (Long Arm)



CODE NO	
LT/700B	6

8 PC: T9, T10, T15, T20, T25, T27, T30, T40

### 740 Series

Spline (XZN) L Keys



Especially for use in automotive sector

CODE NO			
740/M05	M05	75	12 •
740/M06	M06	86	12 •
740/M08	M08	98	12 •
740/M10	M10	110	12 •
740/M12	M12	127	12 •
740/M14	M14	139	12 •

### 700IPR Series

TORX IPR L Keys (Long Arm)

new



Especially for ECU, air conditioning and fuel injection pump applications in automotive

CODE NO			
709IPR	IPR09	89	12 •
710IPR	IPR10	93	12 •
715IPR	IPR15	103	12 •
720IPR	IPR20	116	12 •
725IPR	IPR25	128	12 •
727IPR	IPR27	145	12 •
730IPR	IPR30	166	12 •
740IPR	IPR40	187	12 •

### LT/700IPR

8 Piece TORX IPR L Key Set (Long Arm)



CODE NO	
LT/700IPR	6

8 PC: IPR9, IPR10, IPR15, IPR20, IPR25, IPR27, IPR30, IPR40

### LT/740

5 Piece Spline (XZN) L Key Set



CODE NO	
LT/740	6

5 PC: M05, M06, M08, M10, M12

## T Handle TORX Keys

### K12 Series

T-Handle TORX Keys



CODE NO			
K12-009-100	T9	100	12
K12-010-100	T10	105	12
K12-015-100	T15	105	12
K12-020-150	T20	155	12
K12-025-150	T25	155	12
K12-027-150	T27	155	12
K12-030-150	T30	160	12
K12-040-150	T40	160	12

### K99-12-06

6 Piece C-PLUS T-Handle TORX Key Set (in Colour Box)



CODE NO	
K99-12-06	1

6 PC: T10, T15, T20, T25, T30, T40

### K99-12-M07

7 Piece T-Handle TORX Key Set (on Metal Stand)

new



CODE NO	
K99-12-M07	1

7 PC: T10, T15, T20, T25, T27, T30, T40

K99-12-ME	Empty Metal Stand (for K12 series)	1
-----------	------------------------------------	---

# 02 Wrenches and Hex Keys

## Foldup Key Sets / TORX Flag Drivers

### Foldup Key Sets

Practical folding key sets from Ceta Form.  
Keeps all key sizes together, ideal for field use.  
Available in metric and TORX versions.

- Chrome Vanadium Molybdenum steel
- Gunmetal finish blades
- Ergonomic case design



Practical lever for easy key selection

#### K99-F1-2

6 Piece Foldup Hexagon Key Set



CODE NO

K99-F1-2

6 PC: 2.5, 3, 4, 5, 6, 8 mm



10

#### K99-F2M

9 Piece Foldup Hexagon Key Set #1 (Metal Handle) - SAE



CODE NO

K99-F2M

9 PC: 0.05, 1/16, 5/64, 3/32, 7/64, 1/8, 9/64, 5/32, 3/16 inch



10

#### K99-F3-2

8 Piece Foldup TORX Key Set



CODE NO

K99-F3-2

8 PC: T9, T10, T15, T20, T25, T27, T30, T40



10

#### K99-F2M/2

9 Piece Foldup Hexagon Key Set #2 (Metal Handle) - SAE

**new**



CODE NO

K99-F2/2M

9 PC: 5/64, 3/32, 7/64, 1/8, 9/64, 5/32, 3/16, 7/32, 1/4 inch



10

#### F37 Series

TORX Flag Drivers (P-Handle)



Especially for TORX screws on indexable inserts for milling tools

CODE NO			
F37-06	T06	40	12 •
F37-07	T07	40	12 •
F37-08	T08	40	12 •
F37-09	T09	40	12 •
F37-10	T10	40	12 •
F37-15	T15	40	12 •
F37-20	T20	40	12 •

#### F37-IP Series

TORX PLUS Flag Drivers (P-Handle)



Especially for TORX PLUS screws on indexable inserts for milling tools

CODE NO			
F37-IP08	IP08	40	12 •
F37-IP09	IP09	40	12 •
F37-IP10	IP10	40	12 •
F37-IP15	IP15	40	12 •

3

**CETA FORM**®

Sockets and Accessories



# 03 Sockets and Accessories

## Ceta Form Ratchet Handles



### 90-TOOTH **T90**

High number of teeth yet high torsional strength thanks to a high number of pawl teeth in engagement with gear. Sealed against dust, dirt and water. Arguably the top ratchet in our range.



### 60-TOOTH **COMPACT DESIGN**

Similar mechanism to T90 series with a smaller number of teeth. Ideal for working in confined spaces due to slim head design. Quick release button.



### 48-TOOTH **HIGH TORQUE**

Solid, tried and tested Gear-to-Gear mechanism ensuring higher torque levels and long tool life. Quick release button.

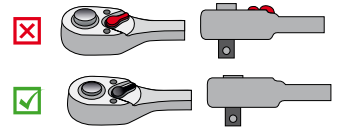

Switch pawls on Ceta Form ratchet handles are placed in a recessed area. Unnecessary contact to the switching pawl is avoided (except T90 series).

6.3  
1/4"

10  
3/8"

12.5  
1/2"

## Sockets



Compact sizes

Precision for perfect fit to nuts & bolts

Knurls to aid non-slip gripping

Female square for perfect fit to ratcheting handle

SQ Drive	Scope mm	Scope SAE	Scope TORX
6.3 1/4"	4 mm - 15 mm	1/8" - 9/16"	E4 - E10
10 3/8"	6 mm - 22 mm	1/4" - 1"	E4 - E20
12.5 1/2"	8 mm - 32 mm	3/8" - 1.1/4"	E10 - E24
20 3/4"	19 mm - 60 mm	7/8" - 1.1/4"	
25 1"	32 mm - 80 mm		

### ETORX Sockets



### Deep Sockets



### Impact Sockets



# Socket Sets in Hard Plastic Cases

Manufactured from high density polyethylene (HDPE) to withstand high and low temperatures



Secure hinges with stainless steel pins and integrated feet to avoid sliding or scratching metal surfaces



Ergonomic handle manufactured from thermoplastic elastomer (TPE) for a comfortable grip



Precision designed cavities for each tool for a comfortable snug fit



Rigid metal latches in matt chromium finish



Embossed identification for each socket and accessory



# 03 Sockets and Accessories

**6.3**  
1/4"

## C02-H Series

1/4" Drive 6-Point Sockets

DIN 3124, TS ISO 2725-1



**6.3**  
1/4"



CODE NO	Ømm	mm	
C02-H040	4	25	12 •
C02-H045	4.5	25	12 •
C02-H050	5	25	12 •
C02-H055	5.5	25	12 •
C02-H060	6	25	12 •
C02-H070	7	25	12 •
C02-H080	8	25	12 •
C02-H090	9	25	12 •
C02-H100	10	25	12 •
C02-H110	11	25	12 •
C02-H120	12	25	12 •
C02-H130	13	25	12 •
C02-H140	14	25	12 •
C02-H150	15	25	6 •
For display carded delivery = Item code + X			6

## C02A-B Series

1/4" Drive 12-Point-Sockets - SAE



**6.3**  
1/4"



CODE NO	Ø"	mm	
C02A-B0316	3/16	25	6 •
C02A-B0732	7/32	25	6 •
C02A-B0104	1/4	25	6 •
C02A-B0932	9/32	25	6 •
C02A-B0516	5/16	25	6 •
C02A-B1132	11/32	25	6 •
C02A-B0308	3/8	25	6 •
C02A-B0716	7/16	25	6 •
C02A-B0102	1/2	25	6 •
C02A-B0916	9/16	25	6 •

## C04-H Series

1/4" Drive 6-Point Deep Sockets

DIN 3124, TS ISO 2725-1



**6.3**  
1/4"



Ideal for long threaded bolts

CODE NO	Ømm	mm	
C04-H040	4	50	12 •
C04-H045	4.5	50	12 •
C04-H050	5	50	12 •
C04-H055	5.5	50	12 •
C04-H060	6	50	12 •
C04-H070	7	50	12 •
C04-H080	8	50	12 •
C04-H090	9	50	12 •
C04-H100	10	50	12 •
C04-H110	11	50	12 •
C04-H120	12	50	12 •
C04-H130	13	50	12 •
C04-H140	14	50	12 •
For display carded delivery = Item code + X			6

## C02-RH13

13 Piece 1/4" Drive 6-Point Socket Set

**new**



**6.3**  
1/4"



CODE NO	
C02-RH13	10

13 PC: 4, 4.5, 5, 5.5, 6, 7, 8, 9, 10, 11, 12, 13, 14 mm

## C02A-RB10

10 Piece 1/4" Drive 12-Point Socket Set - SAE



**6.3**  
1/4"



CODE NO	
C02A-RB10	10

10 PC: 3/16, 7/32, 1/4, 9/32, 5/16, 11/32, 3/8, 7/16, 1/2, 9/16 inch

## C04-RH08

ex code C04-R08

8 Piece 1/4" Drive 6-Point Deep Socket Set



**6.3**  
1/4"



CODE NO	
C04-RH08	10

8 PC: 6, 7, 8, 9, 10, 11, 12, 13 mm

## C02A-H Series

1/4" Drive 6-Point Sockets - SAE

**new**



**6.3**  
1/4"



CODE NO	Ø"	mm	
C02A-H0108	1/8	25	12 •
C02A-H0532	5/32	25	12 •
C02A-H0316	3/16	25	12 •

## C02A-S Series

1/4" Drive Spline Sockets - SAE

**new**



**6.3**  
1/4"



CODE NO	Ø"	mm	
C02A-S0316	3/16	25	12 •
C02A-S0732	7/32	25	12 •
C02A-S0104	1/4	25	12 •
C02A-S0932	9/32	25	12 •
C02A-S0516	5/16	25	12 •
C02A-S1132	11/32	25	12 •
C02A-S0308	3/8	25	12 •
C02A-S0716	7/16	25	12 •

## C04-B Series

1/4" Drive 12-Point Deep Sockets

DIN 3124, TS ISO 2725-1



**6.3**  
1/4"



Ideal for long threaded bolts

CODE NO	Ømm	mm	
C04-B06	6	50	12 •
C04-B07	7	50	12 •
C04-B08	8	50	12 •
C04-B10	10	50	12 •
C04-B13	13	50	12 •
For display carded delivery = Item code + X			6

**6.3**  
1/4"

**C04A-B Series**

1/4" Drive 12-Point Deep Sockets - SAE



**6.3**  
1/4"



Ideal for long threaded bolts

CODE NO	Ø"	mm	Icon
C04A-B0316	3/16	50	6•
C04A-B0732	7/32	50	6•
C04A-B0104	1/4	50	6•
C04A-B0932	9/32	50	6•
C04A-B0516	5/16	50	6•
C04A-B1132	11/32	50	6•
C04A-B0308	3/8	50	6•
C04A-B0716	7/16	50	6•
C04A-B0102	1/2	50	6•
C04A-B0916	9/16	50	6•

**C04A-RB10**

10 Piece 1/4" Drive 12-Point Deep Socket Set - SAE



**6.3**  
1/4"



CODE NO	Icon
C04A-RB10	10
<b>10 PC:</b> 3/16, 7/32, 1/4, 9/32, 5/16, 11/32, 3/8, 7/16, 1/2, 9/16 inch	

**C02UA Series**

1/4" Drive 12-Point Jointed Sockets - SAE



**6.3**  
1/4"



Allows up to 80° entry

CODE NO	Ø"	mm	Icon
C02UA-0732	7/32	36	6
C02UA-0104	1/4	36	6
C02UA-0932	9/32	38	6
C02UA-0516	5/16	38	6
C02UA-1132	11/32	38	6
C02UA-0308	3/8	40	6
C02UA-0716	7/16	40	6
C02UA-0102	1/2	40	6
C02UA-0916	9/16	42	6

**C02UA-RB09**

9 Piece 1/4" Drive 12-Point Jointed Socket Set - SAE



**6.3**  
1/4"



CODE NO	Icon
C02UA-RB09	6
<b>9 PC:</b> 7/32, 1/4, 9/32, 5/16, 11/32, 3/8, 7/16, 1/2, 9/16 inch	

**C06 Series**

1/4" Drive E-TORX Sockets



**6.3**  
1/4"



For external TORX screws

CODE NO	Icon	mm	Icon
C06-04	E04	25	12•
C06-05	E05	25	12•
C06-06	E06	25	12•
C06-07	E07	25	12•
C06-08	E08	25	12•
C06-10	E10	25	12•
For display carded delivery = Item code + X			6

**C06-R06**

6 Piece 1/4" Drive E-TORX Socket Set



**6.3**  
1/4"



CODE NO	Icon
C06-R06	10
<b>6 PC:</b> E04, E05, E06, E07, E08, E10	



# 03 Sockets and Accessories

6.3  
1/4"

## C08S-S Series

1/4" Drive Slotted Socket Bits



6.3  
1/4"



CODE NO	⌀mm	mm	
C08S-S40	4.0	37	12 •
C08S-S55	5.5	37	12 •
C08S-S65	6.5	37	12 •
For display carded delivery = Item code + X			6

## C08S-T Series

1/4" Drive TORX Socket Bits



6.3  
1/4"



CODE NO		mm	
C08S-T06	T06	37	12 •
C08S-T07	T07	37	12 •
C08S-T08	T08	37	12 •
C08S-T09	T09	37	12 •
C08S-T10	T10	37	12 •
C08S-T15	T15	37	12 •
C08S-T20	T20	37	12 •
C08S-T25	T25	37	12 •
C08S-T27	T27	37	12 •
C08S-T30	T30	37	12 •
C08S-T40	T40	37	12 •
For display carded delivery = Item code + X			6

## C08S-TR Series

1/4" Drive TORX Tamper Proof Socket Bits

new



6.3  
1/4"



CODE NO		mm	
C08S-TR08	T08	37	12 •
C08S-TR09	T09	37	12 •
C08S-TR10	T10	37	12 •
C08S-TR15	T15	37	12 •
C08S-TR20	T20	37	12 •
C08S-TR25	T25	37	12 •
C08S-TR27	T27	37	12 •
C08S-TR30	T30	37	12 •
C08S-TR40	T40	37	12 •
For display carded delivery = Item code + X			6

## C08S-PH Series

1/4" Drive Phillips Socket Bits



6.3  
1/4"



CODE NO		mm	
C08S-PH1	PH1	37	12 •
C08S-PH2	PH2	37	12 •
C08S-PH3	PH3	37	12 •
For display carded delivery = Item code + X			6

## C08S-RTX7

7 Piece 1/4" Drive TORX Socket Bit Set



6.3  
1/4"



CODE NO	
C08S-RTX7	10
7 PC: T10, T15, T20, T25, T27, T30, T40	

## C08S-RTR7

7 Piece 1/4" Drive TORX Tamper Proof Socket Set

new



6.3  
1/4"



CODE NO	
C08S-RTR7	10
7 PC: T10, T15, T20, T25, T27, T30, T40	

## C08S-PZ Series

1/4" Drive Pozidriv Socket Bits



6.3  
1/4"



CODE NO		mm	
C08S-PZ1	PZ1	37	12 •
C08S-PZ2	PZ2	37	12 •
C08S-PZ3	PZ3	37	12 •
For display carded delivery = Item code + X			6



**6.3**  
**1/4"**

**C08S-IPR Series**

1/4" Drive TORX IPR Socket Bits



**6.3**  
**1/4"**



Especially for ECU, air conditioning and fuel injection pump applications in automotive

CODE NO		mm	
C08S-IPR10	IPR10	37	12•
C08S-IPR15	IPR15	37	12•
C08S-IPR20	IPR20	37	12•
C08S-IPR25	IPR25	37	12•
C08S-IPR27	IPR27	37	12•
C08S-IPR30	IPR30	37	12•
C08S-IPR40	IPR40	37	12•
	For display carded delivery = Item code + X		6

**C08S-RTP7**

7 Piece 1/4" Drive TORX IPR Socket Bit Set



**6.3**  
**1/4"**



CODE NO	
C08S-RTP7	10
<b>7 PC:</b> IPR10, IPR15, IPR20, IPR25, IPR27, IPR30, IPR40	

**C08S-H Series**

1/4" Drive Hexagon Socket Bits



**6.3**  
**1/4"**



CODE NO	mm	mm	
C08S-H25	2.5	37	12•
C08S-H30	3.0	37	12•
C08S-H40	4.0	37	12•
C08S-H50	5.0	37	12•
C08S-H60	6.0	37	12•
C08S-H70	7.0	37	12•
C08S-H80	8.0	37	12•
	For display carded delivery = Item code + X		6

**C08S-RHX7**

7 Piece 1/4" Drive Hexagon Socket Bit Set



**6.3**  
**1/4"**



CODE NO	
C08S-RHX7	10
<b>7 PC:</b> 2.5, 3, 4, 5, 6, 7, 8 mm	

**C08AS-H Series**

1/4" Drive Hexagon Socket Bits - SAE



**6.3**  
**1/4"**



CODE NO	inch	mm	
C08AS-H0116	1/16	55	6•
C08AS-H0564	5/64	55	6•
C08AS-H0332	3/32	55	6•
C08AS-H0764	7/64	55	6•
C08AS-H0108	1/8	55	6•
C08AS-H0964	9/64	55	6•
C08AS-H0532	5/32	55	6•
C08AS-H0316	3/16	55	6•
C08AS-H0732	7/32	55	6•
C08AS-H0104	1/4	55	6•
C08AS-H0516	5/16	55	6•

**C08AS-RHX11**

11 Piece 1/4" Drive Hexagon Socket Bit Set - SAE



**6.3**  
**1/4"**



CODE NO	
C08AS-RHX11	10
<b>11 PC:</b> 1/16, 5/64, 3/32, 7/64, 1/8, 9/64, 5/32, 3/16, 7/32, 1/4, 5/16 inch	



# 03 Sockets and Accessories

6.3  
1/4"

**C01-11**  
1/4" Drive Quick Release Reversible Ratchet (Compact Head)  
DIN 3122, TS ISO 3315



60-tooth fine mechanism, switch pawl

CODE NO	mm	mm	
C01-11	19	140	6

**C01-12**  
1/4" Drive Quick Release Reversible Ratchet  
DIN 3122, TS ISO 3315



48-tooth strong mechanism, switch pawl

CODE NO	mm	mm	
C01-12	22.5	140	6

**C01-15**  
1/4" Drive Quick Release Reversible Ratchet (Stubby)  
DIN 3122, TS ISO 3315



Stubby design for tight spaces, 48-tooth strong mechanism, switch pawl, quick release

CODE NO	mm	mm	
C01-15	17	95	6

**C01-14**  
1/4" Drive Reversible Ratchet  
DIN 3122, TS ISO 3315

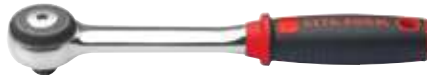

52-tooth robust mechanism, switch disc

CODE NO	mm	mm	
C01-14	26	140	6

**C01-14N**  
1/4" Drive Quick Release Curved Reversible Ratchet **new**  
DIN 3122, TS ISO 3315



45-tooth fine mechanism, switch pawl

CODE NO	mm	mm	
C01-14N	28	150	6

**C01-HLOK**  
1/4" Drive Hi-Lok Reversible Ratchet (Flex) **new**  
DIN 3122, TS ISO 3315



Particularly for use on Hi-Lok fasteners with the aid of a hex key, 48-tooth strong mechanism

CODE NO	mm	mm	
C01-HLOK	23	160	6

**C01-T90**  
1/4" Drive T90 Sealed Reversible Ratchet **new**  
DIN 3122, TS ISO 3315



90-tooth strong mechanism, sealed against dust, dirt etc. for extra long life, switch pawl

CODE NO	mm	mm	
C01-T90	23	112	6



For display carded delivery = Item code + X

**C01-T90L**  
1/4" Drive T90 Sealed Reversible Ratchet (Long Handle) **new**  
DIN 3122, TS ISO 3315



90-tooth strong mechanism, sealed against dust, dirt etc. for extra long life, switch pawl

CODE NO	mm	mm	
C01-T90L	23	154	6



For display carded delivery = Item code + X

**HLD-0564**  
HI-LOK Hex Driver **new**



Particularly for use on Hi-Lok fasteners, used with C01-HLOK

CODE NO	inch	mm	
HLD-0564	5/64	100	6

**6.3**  
**1/4"**

**C01-R Series**

Ratchet Renewal Kits

CODE NO	
C01-11R (for C01-11)	1



C01-12R (for C01-12/ 12MR/ 15)	1
--------------------------------	---



C01-14R (for C01-14)	1
----------------------	---



C01-T90R (for C01-T90)	1
------------------------	---



**C01-35MR**

1/4" Drive Swivel Handle

DIN 3122, TS ISO 3315



**6.3**  
**1/4"**

Allows for up to 90° use

CODE NO	mm	
C01-35MR	145	6

**new**

**C01-20 Series**



1/4" Drive Spinner Handles

DIN 3122, TS ISO 3315

**6.3**  
**1/4"**



C01-20S with phosphated shaft

CODE NO	mm	mm	
C01-20S	25	115	6
C01-20	60	150	6
	For display carded delivery = Item code + X		6

**C01-20F**

1/4" Drive Spinner Handle (Flexible Shaft)



DIN 3122, TS ISO 3315



**6.3**  
**1/4"**



Flexible shaft design for working in restricted areas, **Max. 5 Nm**

CODE NO	mm	mm	
C01-20F	150	240	6
	For display carded delivery = Item code + X		6

**C01-50MR**

1/4" Drive Speeder Brace (Detachable Palm Grip)

DIN 3122, TS ISO 3315

**6.3**  
**1/4"**



Metal body, rotator handle for rapid action, detachable metal palm grip

CODE NO	mm	
C01-50MR	420	3

**C01-60**

1/4" Drive T-Handle Swivel Socket Driver

DIN 3122, TS ISO 3315



**6.3**  
**1/4"**

For deep places, allows for up to 70° use

CODE NO	mm	
C01-60	495	6

**C01-60S**

1/4" Drive T-Handle Socket Driver



**6.3**  
**1/4"**



CODE NO	mm	
C01-60S	230	6

# 03 Sockets and Accessories

6.3  
1/4"

## C01-70 Series

1/4" Drive Extension Bars

DIN 3123, ISO 3316



6.3  
1/4"

CODE NO	mm "	
C01-71	50 - 2"	12
C01-72	75 - 3"	12
C01-73	100 - 4"	12
C01-75	150 - 6"	12
C01-77	250 - 10"	12
C01-78	350 - 14"	12
For display carded delivery = Item code + X		6

## C01-73W

1/4" Drive Wobble Extension Bar



6.3  
1/4"

Ball ended male square drive design allows up to 15° entry



CODE NO	mm "	
C01-73W	100 - 4"	6
For display carded delivery = Item code + X		6

## C01-75F

1/4" Drive Flexible Extension Bar



6.3  
1/4"



Flexible design for working in restricted areas, Max. 5 Nm

CODE NO	mm "	
C01-75F	150 - 6"	12
For display carded delivery = Item code + X		6

## C01-80

1/4" Drive Universal Joint

DIN 3123, ISO 3316



6.3  
1/4"

CODE NO	mm	
C01-80	38	12
For display carded delivery = Item code + X		6

## C01-92

1/4" Drive Socket Adaptor



10  
3/8"

6.3  
1/4"

CODE NO	"	mm	
C01-92	1/4 - 3/8	26	12
For display carded delivery = Item code + X			6

## BT/8001

1/4" Drive Bit Holder Socket



1/4"

6.3  
1/4"

For use with 1/4" bits, spring loaded for quick changes

CODE NO	"	mm	
BT/8001	1/4 - 1/4	25	12

## C012 Series

Metal Clip Rails



Ideal for building custom sets of sockets, used with socket clips

CODE NO	mm	
C012-16	160	6
C012-19	190	6
C012-26	265	6
C012-34	340	6

## C01-C

1/4" Socket Clips - 10 Pieces

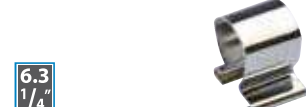

6.3  
1/4"

Socket clips for use on metal clip rails (C012 series)

The code represents a 10 piece package

CODE NO	
C01-C	1 pack

**6.3**  
**1/4"**

**C00-18PH2**

18 Piece 1/4" Drive 6-Point Socket Set (Plastic Case)



**6.3**  
**1/4"**



CODE NO	
C00-18PH2	1



C02-H 4, 4.5, 5, 5.5, 6, 7, 8, 9, 10, 11, 12, 13 mm



C01-12



C01-20



C01-40



C01-70 50 mm, 150 mm



C01-80

**C00-50PH2**

50 Piece 1/4" Drive 6-Point Socket Set (Plastic Case)



**6.3**  
**1/4"**



CODE NO	
C00-50PH2	1



C02-H 4, 4.5, 5, 5.5, 6, 7, 8, 9, 10, 11, 12, 13 mm



C04-H 8, 10, 12, 13 mm



C06 E04, E05, E06, E07, E08, E10



C01-12



C01-20



C01-40

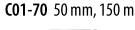

C01-70 50 mm, 150 mm



C01-80



CB/610 4.0, 5.5, 6.5 mm



CB/250 PH1, PH2



CB/350 PZ1, PZ2



CB/800 T10, T15, T20, T25, T30, T40



CB/1800 3, 4, 5, 6 mm



BT/8001 1/4" - 1/4"



L 1.27, 1.5, 2, 2.5 mm

**C00-35PH2**

35 Piece 1/4" Drive 6-Point Socket Set (Plastic Case)



**6.3**  
**1/4"**



CODE NO	
C00-35PH2	1



C02-H 4, 4.5, 5, 5.5, 6, 7, 8, 9, 10, 11, 12, 13 mm



C01-12



C01-20



C01-40

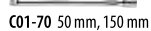

C01-70 50 mm, 150 mm



C01-80



C08S-T T10, T15, T20, T25, T30



C08S-S 5.5 mm



C08S-PH PH2



C08S-H 3, 4, 5, 6 mm

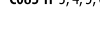

L 1.27, 1.5, 2, 2.5, 3, 4 mm

**C00-27PH5**

27 Piece 1/4" Drive 6-Point Socket Set (Compact Box)

**new**



**6.3**  
**1/4"**



CODE NO	
C00-27PH5	1



C02-H 4, 4.5, 5, 5.5, 6, 7, 8, 9, 10, 11, 12, 13 mm



C01-15



C01-73 100 mm



CB/250 PH1, PH2



CB/1800 3, 4, 5, 6 mm



CB/800 T10, T15, T20, T25, T30, T40



BT/8001 1/4" - 1/4"

**C00-40PH2**

40 Piece 1/4" Drive 6-Point Socket Set (Plastic Case)



**6.3**  
**1/4"**



CODE NO	
C00-40PH2	1



C02-H 4, 4.5, 5, 5.5, 6, 7, 8, 9, 10, 11, 12, 13 mm



C01-12

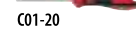

C01-20



C01-40



C01-70 50 mm, 150 mm



C01-80



CB/610 4.0, 5.5, 6.5 mm

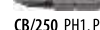

CB/250 PH1, PH2

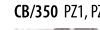

CB/350 PZ1, PZ2



CB/800 T10, T15, T20, T25, T30, T40



CB/1800 3, 4, 5, 6 mm



BT/8001 1/4" - 1/4"

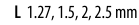

L 1.27, 1.5, 2, 2.5 mm

**C00-17MH4**

17 Piece 1/4" Drive 6-Point Socket Set (Metal Case)



**6.3**  
**1/4"**



CODE NO	
C00-17MH4	1



C02-H 4, 4.5, 5, 5.5, 6, 7, 8, 9, 10, 11, 12, 13 mm



C01-80

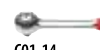

C01-14



C01-40

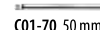

C01-70 50 mm, 150 mm

# 03 Sockets and Accessories

10  
3/8"

## C12-H Series

3/8" Drive 6-Point Sockets

DIN 3124, TS ISO 2725-1



10  
3/8"



CODE NO	Ømm	mm	
C12-H06	6	28	12•
C12-H07	7	28	12•
C12-H08	8	28	12•
C12-H09	9	28	12•
C12-H10	10	28	12•
C12-H11	11	28	12•
C12-H12	12	28	12•
C12-H13	13	28	12•
C12-H14	14	28	12•
C12-H15	15	28	12•
C12-H16	16	30	12•
C12-H17	17	30	12•
C12-H18	18	30	12•
C12-H19	19	30	12•
C12-H21	21	32	12•
C12-H22	22	32	12•



For display carded delivery = Item code + X

6

## C12-RH10

10 Piece 3/8" Drive 6-Point Socket Set

new



10  
3/8"



CODE NO	
C12-RH10	10

10 PC: 10, 11, 12, 13, 14, 15, 16, 17, 18, 19 mm

## C12A-B Series

3/8" Drive 12-Point Sockets - SAE



10  
3/8"



CODE NO	Ø"	mm	
C12A-B0104	1/4	28	6•
C12A-B0516	5/16	28	6•
C12A-B0308	3/8	28	6•
C12A-B0716	7/16	28	6•
C12A-B0102	1/2	28	6•
C12A-B0916	9/16	28	6•
C12A-B0508	5/8	28	6•
C12A-B1116	11/16	30	6•
C12A-B0304	3/4	30	6•
C12A-B1316	13/16	30	6•
C12A-B0708	7/8	30	6•
C12A-B1516	15/16	32	6•
C12A-B1000	1	32	6•

## C12A-RB13

13 Piece 3/8" Drive 12-Point Socket Set - SAE

10  
3/8"



CODE NO	
C12A-RB13	10

13 PC: 1/4, 5/16, 3/8, 7/16, 1/2, 9/16, 5/8, 11/16, 3/4, 13/16, 7/8, 15/16, 1 inch

## C12A-S Series

3/8" Drive Spline Sockets - SAE

new



10  
3/8"



CODE NO	Ø"	mm	
C12A-S0308	3/8	28	12•
C12A-S0716	7/16	28	12•
C12A-S1532	15/32	28	12•
C12A-S0102	1/2	28	12•
C12A-S0916	9/16	28	12•
C12A-S1932	19/32	28	12•
C12A-S0508	5/8	28	12•

## C14-H Series

3/8" Drive 6-Point Deep Sockets

DIN 3124, TS ISO 2725-1



10  
3/8"



Ideal for long threaded bolts

CODE NO	Ømm	mm	
C14-H08	8	63	12•
C14-H09	9	63	12•
C14-H10	10	63	12•
C14-H11	11	63	12•
C14-H12	12	63	12•
C14-H13	13	63	12•
C14-H14	14	63	12•
C14-H15	15	63	12•
C14-H16	16	63	12•
C14-H17	17	63	12•
C14-H18	18	63	12•
C14-H19	19	63	12•



For display carded delivery = Item code + X

6

## C14-RH10

10 Piece 3/8" Drive 6-Point Deep Socket Set

new



10  
3/8"



CODE NO	
C14-RH10	10

10 PC: 10, 11, 12, 13, 14, 15, 16, 17, 18, 19 mm

## C14-RB10

10 Piece 3/8" Drive 12-Point Deep Socket Set

new content



10  
3/8"



CODE NO	
C14-RB10	10

10 PC: 10, 11, 12, 13, 14, 15, 16, 17, 18, 19 mm

10  
3/8"

**C14A-B Series**

3/8" Drive 12-Point Deep Sockets - SAE



10  
3/8"



Ideal for long threaded bolts

CODE NO	inch	mm	Box
C14A-B0104	1/4	63	6•
C14A-B0516	5/16	63	6•
C14A-B0308	3/8	63	6•
C14A-B0716	7/16	63	6•
C14A-B0102	1/2	63	6•
C14A-B0916	9/16	63	6•
C14A-B0508	5/8	63	6•
C14A-B1116	11/16	63	6•
C14A-B0304	3/4	63	6•
C14A-B1316	13/16	63	6•
C14A-B0708	7/8	63	6•
C14A-B1516	15/16	63	6•
C14A-B1000	1	63	6•

**C14A-RB13**

13 Piece 3/8" Drive 12-Point Deep Socket Set - SAE



10  
3/8"



CODE NO	Box
C14A-RB13	10

13 PC: 1/4, 5/16, 3/8, 7/16, 1/2, 9/16, 5/8, 11/16, 3/4, 13/16, 7/8, 15/16, 1 inch

**C12U-RB10**

10 Piece 3/8" Drive 12-Point Joint Socket Set



10  
3/8"



CODE NO	Box
C12U-RB10	6

10 PC: 10, 11, 12, 13, 14, 15, 16, 17, 18, 19 mm

**C15-RH10**

10 Piece 3/8" Drive Crowfoot Wrench Set



10  
3/8"



CODE NO	Box
C15-RH10	6

10 PC: 10, 11, 12, 13, 14, 15, 16, 17, 18, 19 mm

**C16 Series**

3/8" Drive E-TORX Sockets



10  
3/8"



For external TORX screws

CODE NO	inch	mm	Box
C16-04	E04	28	12•
C16-05	E05	28	12•
C16-06	E06	28	12•
C16-07	E07	28	12•
C16-08	E08	28	12•
C16-10	E10	28	12•
C16-11	E11	28	12•
C16-12	E12	28	12•
C16-14	E14	28	12•
C16-16	E16	28	12•
C16-18	E18	28	12•
C16-20	E20	28	12•

For display carded delivery = Item code + X 6

**C16-R10**

10 Piece 1/4"+3/8" Drive E-TORX Socket Set



6.3  
1/4"

10  
3/8"



CODE NO	Box
C16-R10	10

5 PC: E4, E5, E6, E7, E8  
5 PC: E10, E12, E14, E16, E18

**C16D Series**

3/8" Drive E-TORX Deep Sockets

new



10  
3/8"



For external TORX screws, ideal for long threaded bolts

CODE NO	inch	mm	Box
C16D-08	E08	63	6•
C16D-10	E10	63	6•
C16D-12	E12	63	6•
C16D-14	E14	63	6•

For display carded delivery = Item code + X 6

**C16U Series**

3/8" Drive E-TORX Jointed Sockets

new



10  
3/8"



For external TORX screws, ideal for working in areas with restricted access

CODE NO	inch	mm	Box
C16U-08	E08	44	6•
C16U-10	E10	44	6•
C16U-12	E12	44	6•
C16U-14	E14	44	6•

For display carded delivery = Item code + X 6

# 03 Sockets and Accessories

10  
3/8"

## C185-T Series

3/8" Drive TORX Socket Bits



10  
3/8"



CODE NO		mm	
C185-T10	T10	48	12 •
C185-T15	T15	48	12 •
C185-T20	T20	48	12 •
C185-T25	T25	48	12 •
C185-T27	T27	48	12 •
C185-T30	T30	48	12 •
C185-T40	T40	48	12 •
C185-T45	T45	48	12 •
C185-T50	T50	48	12 •
C185-T55	T55	48	12 •
	For display carded delivery = Item code + X		6

## C185-RT09

9 Piece 3/8" Drive TORX Socket Bit Set

**new**



10  
3/8"



CODE NO	
C185-RT09	10
<b>9 PC:</b> T10, T15, T20, T25, T27, T30, T40, T45, T50	

## C11-11

3/8" Drive Quick Release Reversible Ratchet (Compact Head)

DIN 3122, TS ISO 3315



10  
3/8"



60-tooth fine mechanism, switch pawl

CODE NO	mm	mm	
C11-11	27	200	6

## C11-12

3/8" Drive Quick Release Reversible Ratchet

DIN 3122, ISO 3315



10  
3/8"



48-tooth strong mechanism, switch pawl

CODE NO	mm	mm	
C11-12	30.5	200	6

## C185-H Series

3/8" Drive Hexagon Socket Bits



10  
3/8"



CODE NO	mm	mm	
C185-H03	3	48	12 •
C185-H04	4	48	12 •
C185-H05	5	48	12 •
C185-H06	6	48	12 •
C185-H07	7	48	12 •
C185-H08	8	48	12 •
C185-H09	9	48	12 •
C185-H10	10	48	12 •
	For display carded delivery = Item code + X		6

## C185-RH08

8 Piece 3/8" Drive Hexagon Socket Bit Set

**new**



10  
3/8"



CODE NO	
C185-RH08	10
<b>8 PC:</b> 3, 4, 5, 6, 7, 8, 9, 10 mm	

## C11-14

3/8" Drive Reversible Ratchet

DIN 3122, ISO 3315

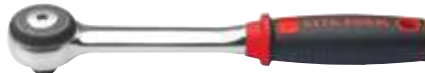

10  
3/8"



52-tooth robust mechanism, switch disc

CODE NO	mm	mm	
C11-14	34	200	6

## C11-14N

3/8" Drive Quick Release Curved Reversible Ratchet

DIN 3122, TS ISO 3315

**new**



10  
3/8"



45-tooth fine mechanism, switch pawl

CODE NO	mm	mm	
C11-14N	33	200	6

## C11-37

3/8" Drive Swivel Handle (Soft Grip)

DIN 3122, TS ISO 3315



10  
3/8"

Allows for up to 90° use

CODE NO	mm	
C11-37	250	6

## C11-36MR

3/8" Drive Swivel Handle (Metal Handle)

**new**

DIN 3122, TS ISO 3315



10  
3/8"

Allows for up to 90° use

CODE NO	mm	
C11-36MR	215	6

## C11-T90

3/8" Drive T90 Sealed Reversible Ratchet

**new**

DIN 3122, TS ISO 3315



10  
3/8"



90-tooth strong mechanism, sealed against dust, dirt etc. for extra long life, switch pawl

CODE NO	mm	mm	
C11-T90	30	200	6
	For display carded delivery = Item code + X		6

10  
3/8"

**C11-20 Series**

3/8" Drive Spinner Handles

DIN 3122, TS ISO 3315



**new**

10  
3/8"

CODE NO	mm	mm	
C11-20S	30	130	6
C11-20	60	160	6
 For display carded delivery = Item code + X			6

**C11-R Series**

Ratchet Renewal Kits

CODE NO	
C11-11R (for C11-11)	1



C11-12R (for C11-12 / C11-12MR)	1
---------------------------------	---



C11-14R (for C11-14)	1
----------------------	---



C11-T90R (for C11-T90)	1
------------------------	---



**C11-40**

3/8" Drive Sliding T-Handle

DIN 3122, TS ISO 3315



10  
3/8"

CODE NO	mm	
C11-40	200	12
 For display carded delivery = Item code + X		6

**C11-50MR**

3/8" Drive Speeder Brace (Detachable Palm Grip)

DIN 3122, TS ISO 3315



10  
3/8"

Metal body, rotator handle for rapid action, detachable metal palm grip

CODE NO	mm	
C11-50MR	420	3

**C11-60**

3/8" Drive T-Handle Swivel Socket Driver

DIN 3122, TS ISO 3315



10  
3/8"

For deep places, allows for up to 70° use

CODE NO	mm	
C11-60	500	3

**C11-70 Series**

3/8" Drive Extension Bars

DIN 3123, ISO 3316



10  
3/8"

CODE NO	mm	
C11-72	75 - 3"	12
C11-75	150 - 6"	12
C11-77	250 - 10"	12
C11-78	300 - 12"	6
C11-79	450 - 18"	6
 For display carded delivery = Item code + X		6

**C11-70W Series**

3/8" Drive Wobble Extension Bars



10  
3/8"

Ball ended male square drive allows up to 15° entry



CODE NO	mm	
C11-72W	75 - 3"	6
C11-75W	150 - 6"	6
 For display carded delivery = Item code + X		6

**C11-76F**

3/8" Drive Flexible Extension Bar

**new**



10  
3/8"

Flexible design for working in restricted areas, Max. 7 Nm

CODE NO	mm	
C11-76F	200 - 8"	6
 For display carded delivery = Item code + X		6

# 03 Sockets and Accessories

10  
3/8"

## C11-60S

3/8" Drive T-Handle Socket Driver



10  
3/8" Quick Release

CODE NO	mm	
C11-60S	230	6

## C11-80

3/8" Drive Universal Joint

DIN 3123, ISO 3316



10  
3/8"

CODE NO	mm	
C11-80	53	12
	For display carded delivery = Item code + X	
		6

## C11-91

3/8" Drive Socket Adaptor - F:3/8" M:1/4"

DIN 3123, ISO 3316



6.3  
1/4"

10  
3/8"

CODE NO	"	mm	
C11-91	3/8 - 1/4	28	12
	For display carded delivery = Item code + X		
			6

## C11-92S

3/8" Drive Socket Adaptor - F:3/8" M:1/2"

DIN 3123, ISO 3316



12.5  
1/2"

10  
3/8"

CODE NO	"	mm	
C11-92S	3/8 - 1/2	43	12
	For display carded delivery = Item code + X		
			6

## C11-92

3/8" Drive Socket Adaptor (3-Way) - F:3/8" M:1/2"

DIN 3123, ISO 3316



12.5  
1/2"

10  
3/8"

3-Way design suitable for use with extension bars

CODE NO	"	mm	
C11-92	3/8 - 1/2	43	12
	For display carded delivery = Item code + X		
			6

## BT/8000 3/8" Series

3/8" Drive Bit Holder Sockets



10  
3/8"

For use with 1/4", 5/16" or H10 bits, spring loaded for quick changes

CODE NO	"	mm	
BT/8003	1/4"	28	6
BT/8004	5/16"	28	6
BT/8005	10 mm	28	6

## C012 Series

Metal Clip Rails



Ideal for building custom sets of sockets, used with socket clips

CODE NO	mm	
C012-16	160	6
C012-19	190	6
C012-26	265	6
C012-34	340	6

## C11-C

3/8" Socket Clips - 10 Pieces



10  
3/8"

Socket clips for use on metal clip rails (C012 series)

The code represents a 10 piece package

CODE NO	
C11-C	1 pack



10  
3/8"

**C10-20PH2**

20 Piece 3/8" Drive 6-Point Socket Set (Plastic Case)



10  
3/8"

CODE NO

C10-20PH2



1



C11-70 75 mm, 150 mm

C12-H 6, 7, 8, 9, 10, 11, 12, 13, 14, 15, 16, 17, 19, 22 mm



C11-80



C17-R16 16 mm



C11-12

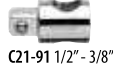

C21-91 1/2" - 3/8"

**C10-38PH2**

38 Piece 3/8" Drive 6-Point Socket and Wrench Set (Plastic Case)



10  
3/8"

CODE NO

C10-38PH2



1

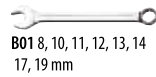

B01 8, 10, 11, 12, 13, 14, 17, 19 mm



C11-80

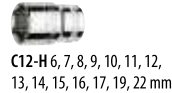

C12-H 6, 7, 8, 9, 10, 11, 12, 13, 14, 15, 16, 17, 19, 22 mm

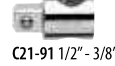

C21-91 1/2" - 3/8"



C17-R16 16 mm

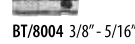

BT/8004 3/8" - 5/16"



C11-12

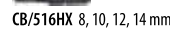

CB/516HX 8, 10, 12, 14 mm

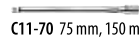

C11-70 75 mm, 150 mm



CB/516TX T30, T40, T45, T50, T55

**C10-18MH4**

18 Piece 3/8" Drive 6-Point Socket Set (Metal Case)



10  
3/8"

CODE NO

C10-18MH4



1



C11-70 75 mm, 150 mm

C12-H 6, 7, 8, 10, 11, 12, 13, 14, 15, 16, 17, 19, 22 mm

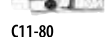

C11-80



C11-14



C21-91 1/2" - 3/8"

**Multi-Fix**

Socket Range

The ideal all-rounder system for working on metric hexagon, SAE hexagon, TORX, square and spline fixings. Hollow sockets ideal also for protruding bolts.

- Hardened and tempered 31CrV3 steel
- Mirror polished chrome finish for corrosion resistance
- Thin wall and arch design can increase driving torque by up to 40%.



YouTube Clip



Multi-purpose socket wrenches fit all the bolts.



CONVERSION CHART

CODE NO	mm	inch	E-TORX	Square
C11G-H10	10	3/8"	E12	8
C11G-H11	11	7/16"	E14	9
C11G-H12	12	15/32"	E16	10
C11G-H13	13	1/2"		
C11G-H14	14	9/16"	E18	
C11G-H15	15	19/32"		12
C11G-H16	16	5/8"	E20	13
C11G-H17	17	21/32"		14
C11G-H18	18	11/16"	E22	
C11G-H19	19	3/4"	E24	
C11G-H21	21	13/16"	E26	17
C11G-H22	22	7/8"	E28	18

**C10-15PG1**

15 Piece Multi-Fix Hollow Socket Set (Plastic Case)



19  
mm

CODE NO

C10-15PG1



1



C11G-H 10, 11, 12, 13, 14, 15, 16, 17, 18, 19, 21, 22 mm



C11-11G

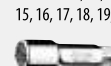

C11-72G 80 mm



C11G-RA02 3/8"

# 03 Sockets and Accessories

12.5  
1/2"

## C22-H Series

1/2" Drive 6-Point Sockets

DIN 3124, TS ISO 2725-1



12.5  
1/2"



CODE NO	mm	mm	
C22-H08	8	38	12•
C22-H09	9	38	12•
C22-H10	10	38	12•
C22-H11	11	38	12•
C22-H12	12	38	12•
C22-H13	13	38	12•
C22-H14	14	38	12•
C22-H15	15	38	12•
C22-H16	16	38	12•
C22-H17	17	38	12•
C22-H18	18	38	12•
C22-H19	19	38	12•
C22-H20	20	38	12•
C22-H21	21	38	12•
C22-H22	22	40	12•
C22-H23	23	40	6•
C22-H24	24	42	6•
C22-H25	25	42	6•
C22-H26	26	42	6•
C22-H27	27	43	6•
C22-H28	28	43	6•
C22-H29	29	44	6•
C22-H30	30	46	6•
C22-H32	32	46	6•
For display carded delivery = Item code + X			6

## C22-B Series

1/2" Drive 12-Point Sockets

DIN 3124, TS ISO 2725-1



12.5  
1/2"



CODE NO	mm	mm	
C22-B08	8	38	12•
C22-B09	9	38	12•
C22-B10	10	38	12•
C22-B11	11	38	12•
C22-B12	12	38	12•
C22-B13	13	38	12•
C22-B14	14	38	12•
C22-B15	15	38	12•
C22-B16	16	38	12•
C22-B17	17	38	12•
C22-B18	18	38	12•
C22-B19	19	38	12•
C22-B20	20	38	12•
C22-B21	21	39	12•
C22-B22	22	40	12•
C22-B23	23	40	6•
C22-B24	24	42	6•
C22-B25	25	42	6•
C22-B26	26	42	6•
C22-B27	27	43	6•
C22-B28	28	43	6•
C22-B29	29	43	6•
C22-B30	30	46	6•
C22-B32	32	46	6•
For display carded delivery = Item code + X			6

## C22A-B Series

1/2" Drive 12-Point Sockets - SAE



12.5  
1/2"



CODE NO	inch	mm	
C22A-B03	3/8	38	6•
C22A-B04	7/16	38	6•
C22A-B05	1/2	38	6•
C22A-B06	9/16	38	6•
C22A-B06/2	19/32	38	6•
C22A-B07	5/8	38	6•
C22A-B08	11/16	38	6•
C22A-B09	3/4	38	6•
C22A-B09/2	25/32	38	6•
C22A-B10	13/16	38	6•
C22A-B11	7/8	38	6•
C22A-B12	15/16	38	6•
C22A-B13	1	40	6•
C22A-B14	1-1/16	42	6•
C22A-B15	1-1/8	44	6•
C22A-B16	1-3/16	44	6•
C22A-B17	1-1/4	44	6•
For display carded delivery = Item code + X			6

## C22-RH11

11 Piece 1/2" Drive 6-Point Socket Set

new



12.5  
1/2"



CODE NO	
C22-RH11	10
<b>11 PC:</b> 10, 11, 12, 13, 14, 15, 16, 17, 19, 21, 22 mm	

## C22-RB11

11 Piece 1/2" Drive 12-Point Socket Set

new



12.5  
1/2"



CODE NO	
C22-RB11	10
<b>11 PC:</b> 10, 11, 12, 13, 14, 15, 16, 17, 19, 21, 22 mm	

## C22A-RB11

11 Piece 1/2" Drive 12-Point Socket Set - SAE



12.5  
1/2"



CODE NO	
C22A-RB11	10
<b>11 PC:</b> 3/8, 7/16, 1/2, 9/16, 5/8, 11/16, 3/4, 13/16, 7/8, 15/16, 1 inch	

12.5  
1/2"

### C24-H Series

1/2" Drive 6-Point Deep Sockets

DIN 3124, TS ISO 2725-1



12.5  
1/2"

Ideal for long threaded bolts

CODE NO	mm	mm	
C24-H08	8	77	12•
C24-H10	10	77	12•
C24-H11	11	77	12•
C24-H12	12	77	12•
C24-H13	13	77	12•
C24-H14	14	77	12•
C24-H15	15	77	12•
C24-H16	16	77	12•
C24-H17	17	77	12•
C24-H18	18	77	12•
C24-H19	19	77	12•
C24-H20	20	77	12•
C24-H21	21	77	12•
C24-H22	22	77	12•
C24-H24	24	77	6•
C24-H27	27	77	6•
C24-H30	30	77	6•
C24-H32	32	77	6•
 For display carded delivery = Item code + X			6

### C24-B Series

1/2" Drive 12-Point Deep Sockets

DIN 3124, TS ISO 2725-1



12.5  
1/2"

Ideal for long threaded bolts

CODE NO	mm	mm	
C24-B08	8	77	12•
C24-B10	10	77	12•
C24-B11	11	77	12•
C24-B12	12	77	12•
C24-B13	13	77	12•
C24-B14	14	77	12•
C24-B15	15	77	12•
C24-B16	16	77	12•
C24-B17	17	77	12•
C24-B18	18	77	12•
C24-B19	19	77	12•
C24-B20	20	77	12•
C24-B21	21	77	12•
C24-B22	22	77	12•
C24-B24	24	77	6•
C24-B27	27	77	6•
C24-B30	30	77	6•
C24-B32	32	77	6•
 For display carded delivery = Item code + X			6

### C26 Series

1/2" Drive E-TORX Sockets



12.5  
1/2"

For external TORX screws

CODE NO		mm	
C26-10	E10	38	12•
C26-11	E11	38	12•
C26-12	E12	38	12•
C26-14	E14	38	12•
C26-16	E16	38	12•
C26-18	E18	38	12•
C26-20	E20	38	12•
C26-22	E22	38	12•
C26-24	E24	38	12•
 For display carded delivery = Item code + X			6

### C24-RH09

ex code C24-R09

9 Piece 1/2" Drive 6-Point Deep Socket Set



12.5  
1/2"



CODE NO	
C24-RH09	5
9 PC: 10, 11, 12, 13, 14, 17, 19, 21, 22 mm	

### C24-RB09

9 Piece 1/2" Drive 12-Point Deep Socket Set



12.5  
1/2"



CODE NO	
C24-RB09	5
9 PC: 10, 11, 12, 13, 14, 17, 19, 21, 22 mm	

### C26-R08

8 Piece 1/2" Drive E-TORX Socket Set



12.5  
1/2"



CODE NO	
C26-R08	10
8 PC: E10, E12, E14, E16, E18, E20, E22, E24	

# 03 Sockets and Accessories

12.5  
1/2"

## Socket Bits Range



- Comprehensive range of profiles and sizes
- Precision machined and hardened, tempered bits
- Turned down bit body for some profiles for better access to restricted areas
- Large, stamped markings for readability

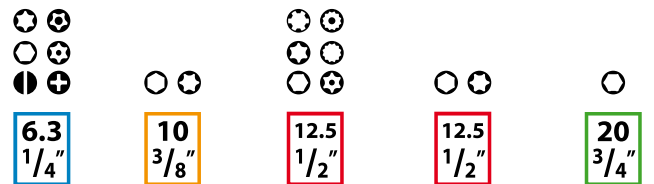

### C28S-T Series

1/2" Drive TORX Socket Bits - Short



CODE NO		mm	
C28S-T20	T20	55	12 •
C28S-T25	T25	55	12 •
C28S-T27	T27	55	12 •
C28S-T30	T30	55	12 •
C28S-T35	T35	55	12 •
C28S-T40	T40	55	12 •
C28S-T45	T45	55	12 •
C28S-T50	T50	55	12 •
C28S-T55	T55	55	6 •
C28S-T60	T60	55	6 •
C28S-T70	T70	55	6 •
	For display carded delivery = Item code + X		6

### C28S-TL Series

1/2" Drive TORX Socket Bits - Long



CODE NO		mm	
C28S-T20L	T20	100	12 •
C28S-T25L	T25	100	12 •
C28S-T27L	T27	100	12 •
C28S-T30L	T30	100	12 •
C28S-T35L	T35	100	12 •
C28S-T40L	T40	100	12 •
C28S-T45L	T45	100	12 •
C28S-T50L	T50	100	12 •
C28S-T55L	T55	100	6 •
C28S-T60L	T60	100	6 •
C28S-T70L	T70	100	6 •
	For display carded delivery = Item code + X		6

### C28S-TR Series

1/2" Drive TORX Tamper Proof Socket Bits - Short



CODE NO		mm	
C28S-TR30	T30	55	6 •
C28S-TR40	T40	55	6 •
C28S-TR45	T45	55	6 •
C28S-TR50	T50	55	6 •
C28S-TR55	T55	55	6 •
	For display carded delivery = Item code + X		6

### C28S-RT9

9 Piece 1/2" Drive TORX Socket Bit Set - Short

**new**



CODE NO		
C28S-RT9		10
9 PC: T20, T25, T27, T30, T40, T45, T50, T55, T60		

### C28S-TR30XL

1/2" Drive TORX Tamper Proof Socket Bit - Extra Long



CODE NO		mm	
C28S-TR30XL	T30	140	6 •
	For display carded delivery = Item code + X		6

Especially for airbag screw on vehicles

12.5  
1/2"

### C28S-H Series

1/2" Drive Hexagon Socket Bits - Short



12.5  
1/2"



CODE NO	Ømm	mm	
C28S-H04	4	55	12•
C28S-H05	5	55	12•
C28S-H06	6	55	12•
C28S-H07	7	55	12•
C28S-H08	8	55	12•
C28S-H09	9	55	12•
C28S-H10	10	55	12•
C28S-H12	12	55	12•
C28S-H14	14	55	6•
C28S-H17	17	60	6•
C28S-H19	19	60	6•
For display carded delivery = Item code + X			6

### C28S-RH9

9 Piece 1/2" Drive Hexagon Socket Bit Set - Short **new**



12.5  
1/2"



CODE NO	
C28S-RH9	10
9 PC: 4, 5, 6, 7, 8, 10, 12, 14, 17 mm	

### C28S-HL Series

1/2" Drive Hexagon Socket Bits - Long



12.5  
1/2"



CODE NO	Ømm	mm	
C28S-H05L	5	100	12•
C28S-H06L	6	100	12•
C28S-H07L	7	100	12•
C28S-H08L	8	100	12•
C28S-H09L	9	100	12•
C28S-H10L	10	100	12•
C28S-H12L	12	100	12•
C28S-H13L	13	100	6•
For display carded delivery = Item code + X			6

### C28S-HXL Series

1/2" Drive Hexagon Socket Bits - Extra Long



12.5  
1/2"



CODE NO	Ømm	mm	
C28S-H06XL	6	140	6•
C28S-H06XL2	6	220	6•
C28S-H10XL	10	140	6•
C28S-H12XL	12	140	6•
For display carded delivery = Item code + X			6

### C28S-X Series

1/2" Drive XZN Socket Bits - Short



12.5  
1/2"



Especially for use in automotive

CODE NO		mm	
C28S-X05	M05	55	6•
C28S-X06	M06	55	6•
C28S-X08	M08	55	6•
C28S-X10	M10	55	6•
C28S-X12	M12	55	6•
C28S-X14	M14	55	6•
C28S-X16	M16	55	6•
For display carded delivery = Item code + X			6

### C28S-RX6

6 Piece 1/2" Drive XZN Socket Bit Set - Short

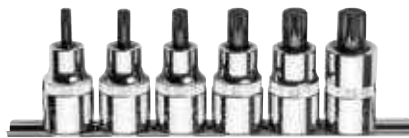

12.5  
1/2"



CODE NO		
C28S-RX6		10
6 PC: M05, M06, M08, M10, M12, M14		

### C28S-HBXL Series

1/2" Drive Ball End Hexagon Socket Bits - Extra Long



12.5  
1/2"



Ball end allows up to 25° entry  
Especially for tight spaces like starter motors, manifolds etc.

CODE NO	Ømm	mm	
C28S-HB05XL	5	140	6•
C28S-HB06XL	6	140	6•
C28S-HB07XL	7	140	6•
C28S-HB08XL	8	140	6•
C28S-HB10XL	10	140	6•
For display carded delivery = Item code + X			6

### C28S-X.L Series

1/2" Drive XZN Socket Bits - Long



12.5  
1/2"



Especially for use in automotive

CODE NO		mm	
C28S-X06L	M06	100	6•
C28S-X08L	M08	100	6•
C28S-X10L	M10	100	6•
C28S-X12L	M12	100	6•
C28S-X14L	M14	100	6•
For display carded delivery = Item code + X			6

### C28S-X.XL Series

1/2" Drive XZN Socket Bits - Extra Long



12.5  
1/2"



Especially for screws on cylinder heads (VW, AUDI, OPEL, TOYOTA)

CODE NO		mm	
C28S-X10XL	M10	140	6•
C28S-X12XL	M12	140	6•
For display carded delivery = Item code + X			6

# 03 Sockets and Accessories

12.5  
1/2"

## C28S-XT16

1/2" Drive XZN Tamper Proof Socket Bit - Short



12.5  
1/2"



Especially for oil sump plug in gearbox

CODE NO		mm	
C28S-XT16	M16	55	6
For display carded delivery = Item code + X			6

## C28S-RL Series

1/2" Drive RIBE Socket Bits - Long



12.5  
1/2"



Especially for RIBE screws on Italian cars

CODE NO		mm	
C28S-R05L	M05	99	6
C28S-R06L	M06	99	6
C28S-R08L	M08	99	6
C28S-R10L	M10	99	6
C28S-R12L	M12	99	6
C28S-R14L	M14	99	6
For display carded delivery = Item code + X			6

## C28S-RR6L

6 Piece 1/2" Drive RIBE Socket Bit Set - Long



12.5  
1/2"



CODE NO	
C28S-RR6L	10
6 PC: M05, M06, M08, M10, M12, M14	

## C28-TS13

13 Piece H10 TORX Bit Set



12.5  
1/2"



10  
mm

CODE NO	
C28-TS13	1
BT/8008 1/2" - 10 mm	
CB/1100 T30, T40, T45, T50, T55, T60	
CB/1000 T30, T40, T45, T50, T55, T60	

## C28-SS40

40 Piece H10 TORX/Hex/XZN Bit Set

new  
content



10  
3/8"

12.5  
1/2"

10  
mm

CODE NO	
C28-SS40	1
BT/8005 3/8" - 10 mm	
BT/8008 1/2" - 10 mm	
CB/2000 4, 5, 6, 7, 8, 10, 12 mm	
CB/2100 4, 5, 6, 7, 8, 10, 12 mm	
CB/1000 T20, T25, T30, T40, T45, T50, T55	
CB/3000 M5, M6, M8, M10, M12	
CB/1100 T20, T25, T30, T40, T45, T50, T55	
CB/3100 M5, M6, M8, M10, M12	

## C28-XS11

11 Piece H10 XZN (Spline) Bit Set



12.5  
1/2"



10  
mm

CODE NO	
C28-XS11	1
BT/8008 1/2" - 10 mm	
CB/3100 M6, M8, M10, M12	
CB/3000 M5, M6, M8, M10, M12, M14	



12.5  
1/2"

**C21-11**

1/2" Drive Quick Release Reversible Ratchet (Compact Head)

DIN 3122, TS ISO 3315



60-tooth fine mechanism, switch pawl

CODE NO	mm	mm	
C21-11	32	255	6

**C21-12**

1/2" Drive Quick Release Reversible Ratchet

DIN 3122, TS ISO 3315



48-tooth strong mechanism, switch pawl

CODE NO	mm	mm	
C21-12	41.5	260	6

**C21-14**

1/2" Drive Reversible Ratchet

DIN 3122, TS ISO 3315



52-tooth robust mechanism, switch disc

CODE NO	mm	mm	
C21-14	41	265	6

**C21-14N**

1/2" Drive Quick Release Curved Reversible Ratchet **new**

DIN 3122, TS ISO 3315



45-tooth fine mechanism, switch pawl

CODE NO	mm	mm	
C21-14N	39	250	6

**C21-T90**

1/2" Drive T90 Sealed Reversible Ratchet **new**

DIN 3122, TS ISO 3315



90-tooth strong mechanism, sealed against dust, dirt etc. for extra long life, switch pawl

CODE NO	mm	mm	
C21-T90	41	255	6



For display carded delivery = Item code + X

**C21-30 Series**

1/2" Drive Swivel Handles

DIN 3122, TS ISO 3315



Allows for up to 90° use

CODE NO	mm	
C21-38	375	6
C21-39	475	6

**C21-R Series**

Ratchet Renewal Kits

CODE NO	
C21-11R (for C21-11)	1



YouTube Clip

CODE NO	
C21-12R (for C21-12 / 12MR)	1



YouTube Clip

CODE NO	
C21-14R (for C21-14)	1



YouTube Clip

CODE NO	
C21-T90R (for C21-T90)	1



# 03 Sockets and Accessories

12.5  
1/2"

## C21-60S 1/2" Drive T-Handle Socket Driver



12.5  
1/2" Quick Release

CODE NO	mm	
C21-60S	230	6

## C21-20 1/2" Drive Offset Handle

DIN 3122, TS ISO 3315



12.5  
1/2"

CODE NO	mm	
C21-20	250	12

## C21-40 Series 1/2" Drive Sliding T-Handles

DIN 3122, TS ISO 3315



12.5  
1/2"

CODE NO	mm	
C21-40	250	12
C21-40L	300	12
 For display carded delivery = Item code + X		6

## C21-50 1/2" Drive Speeder Brace

DIN 3122, TS ISO 3315

new  
design



12.5  
1/2"

Rotator handle for rapid action

CODE NO	mm	
C21-50	420	3

## C21-60 1/2" Drive T-Handle Swivel Socket Driver

DIN 3122, TS ISO 3315



12.5  
1/2"

For deep places, allows for up to 70° use

CODE NO	mm	
C21-60	500	3

## C21-70 Series 1/2" Drive Extension Bars

DIN 3123, ISO 3316



12.5  
1/2"

CODE NO	mm	
C21-72	75 - 3"	12
C21-74	125 - 5"	12
C21-77	250 - 10"	12
 For display carded delivery = Item code + X		6

## C21-70W Series 1/2" Drive Wobble Extension Bars



12.5  
1/2"

Ball ended male square allows up to 15° entry

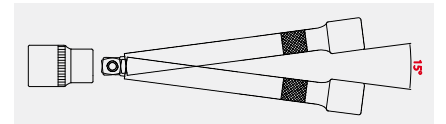

CODE NO	mm	
C21-71W	50 - 2"	6
C21-74W	125 - 5"	6
C21-77W	250 - 10"	6
C21-79W	500 - 20"	6
 For display carded delivery = Item code + X		6

## C21-80 1/2" Drive Universal Joint

DIN 3123, ISO 3316



12.5  
1/2"

CODE NO	mm	
C21-80	73	12
 For display carded delivery = Item code + X		6



12.5  
1/2"

**C21-91S**

1/2" Drive Socket Adaptor - F:1/2" M:3/8"

DIN 3123, ISO 3316

10  
3/8"



12.5  
1/2"

CODE NO	"	"	mm	
C21-91S	1/2 - 3/8	38	12.5	6

For display carded delivery = Item code + X

**C21-91**

1/2" Drive Socket Adaptor (3 Ways) - F:1/2" M:3/8"

DIN 3123, ISO 3316

10  
3/8"



12.5  
1/2"

3-Way design suitable for use with extension bars

CODE NO	"	"	mm	
C21-91	1/2 - 3/8	38	12.5	6

For display carded delivery = Item code + X

**C21-90KIT6**

6 Piece Socket Adaptor Set

**new**



CODE NO	
C21-90KIT6	1

**6 PC:** C01-92 (F:1/4 - M: 3/8),  
C11-91 (F:3/8 - M: 1/4), C11-92S (F:3/8 - M: 1/2),  
C21-91S (F:1/2 - M: 3/8), C21-92 (F:1/2 - M: 3/4),  
C31-91 (F:3/4 - M: 1/2)

**C21-92**

1/2" Drive Socket Adaptor - F:1/2" M:3/4"

DIN 3123, ISO 3316

20  
3/4"



12.5  
1/2"

CODE NO	"	"	mm	
C21-92	1/2 - 3/4	50	12.5	6

For display carded delivery = Item code + X

**BT/8000 1/2" Series**

1/2" Drive Bit Holder Sockets

For use with 5/16" or H10 bits, spring loaded for quick changes

10  
3/8"



12.5  
1/2"

CODE NO	"	mm	
BT/8007	5/16"	28	6
BT/8008	10 mm	38	6

**C012 Series**

Metal Clip Rails (Empty)



Ideal for building custom sets of sockets, used with socket clips

CODE NO	mm	
C012-16	160	6•
C012-19	190	6•
C012-26	265	6•
C012-34	340	6•

**C21-C**

1/2" Socket Clips - 10 Pieces

12.5  
1/2"



Socket clips for use on metal clip rails (C012 series)

The code represents a 10 piece package

CODE NO	
C21-C	1 pack



# 03 Sockets and Accessories

12.5  
1/2"

## C20-18PH2

18 Piece 1/2" Drive 6-Point Socket Set (Plastic Case)



12.5  
1/2"



CODE NO	
C20-18PH2	1
C22-H 10, 11, 12, 13, 14, 15, 17, 19, 22, 24, 27, 30, 32 mm	C21-12
C21-70 125 mm, 250 mm	
C11-92 3/8" - 1/2"	C21-80

## C20-25PH2

25 Piece 1/2" Drive 6-Point Socket Set (Plastic Case)



12.5  
1/2"



CODE NO	
C20-25PH2	1
C22-H 8, 9, 10, 11, 12, 13, 14, 15, 16, 17, 18, 19, 21, 22, 24, 27, 30, 32 mm	C21-70 125 mm, 250 mm
C27-R 16, 21 mm	C21-80
C21-12	C11-92 3/8" - 1/2"

## C20-25PB2

25 Piece 1/2" Drive 12-Point Socket Set (Plastic Case)



12.5  
1/2"



CODE NO	
C20-25PB2	1
C22-B 8, 9, 10, 11, 12, 13, 14, 15, 16, 17, 18, 19, 21, 22, 24, 27, 30, 32 mm	C21-70 125 mm, 250 mm
C27-R 16, 21 mm	C11-92 3/8" - 1/2"
C21-12	C21-80

## C20A-24PB2

24 Piece 1/2" Drive 12-Point Socket Set (Plastic Case) - SAE



12.5  
1/2"



CODE NO	
C20A-24PB2	1
C22A-B 3/8", 7/16", 1/2", 9/16", 19/32", 5/8", 11/16", 3/4", 25/32", 13/16", 7/8", 15/16", 1", 1-1/16", 1-1/8", 1-3/16", 1-1/4"	C21-70 125 mm, 250 mm
C27-R 16, 21 mm	C11-92 3/8" - 1/2"
C21-12	C21-80



12.5  
1/2"

**C20-47PH2**

47 Piece 1/2" Drive 6-Point Socket and Wrench Set (Plastic Case)



12.5  
1/2"

CODE NO	Image	Quantity
C20-47PH2		1

**B01** 8, 9, 10, 11, 12, 13, 14, 15, 16, 17, 19, 22 mm

**C22-H** 8, 9, 10, 11, 12, 13, 14, 15, 16, 17, 18, 19, 21, 22, 24, 27, 30, 32 mm

**C27-R** 16, 21 mm

**C21-12**

**C21-70** 125 mm, 250 mm

**C21-80**

**C11-92** 3/8" - 1/2"

**BT/8007** 1/2" - 5/16"

**CB/516TX** T30, T40, T45, T50, T55

**CB/516HX** 8, 10, 12, 14 mm

**C20-85PH2**

85 Piece 1/4" + 1/2" Drive 6-Point Socket Set (Plastic Case)



6.3  
1/4" 12.5  
1/2"

CODE NO	Image	Quantity
C20-85PH2		1

**C02-H** 4, 4.5, 5, 5.5, 6, 7, 8, 9, 10, 11, 12, 13 mm

**C04-H** 6, 7, 8, 9, 10, 11, 12, 13 mm

**C22-H** 10, 11, 12, 13, 14, 15, 16, 17, 18, 19, 21, 22, 24, 27, 30, 32 mm

**C24-H** 14, 17, 19, 22 mm

**C27-R** 16, 21 mm

**C01-12**

**C21-12**

**C01-20**

**C01-40**

**C01-70** 50 mm, 150 mm

**C21-70** 125 mm, 250 mm

**L** 1.5, 2, 2.5 mm

**C11-92** 3/8" - 1/2"

**C01-80**

**C21-80**

**BT/8001** 1/4" - 1/4"

**BT/8007** 1/2" - 5/16"

**CB/612** 5.5 mm

**CB/252** PH2

**CB/352** PZ2

**CB/800** T10, T15, T20, T25, T30, T40

**CB/1800** 3, 4, 5, 6 mm

**CB/516XZ** M06, M08, M10, M12, M14

**CB/516HX** 8, 10, 12, 14 mm

**CB/516TX** T30, T40, T45, T50, T55

**C20-23MH4**

23 Piece 1/2" Drive 6-Point Socket Set (Metal Case)



12.5  
1/2"

CODE NO	Image	Quantity
C20-23MH4		1

**C22-H** 8, 9, 10, 11, 12, 13, 14, 15, 16, 17, 18, 19, 21, 22, 24, 27, 30, 32 mm

**C21-14**

**C21-70** 125 mm, 250 mm

**C21-80**

**C11-92** 3/8" - 1/2"

**C20-35MH4**

35 Piece 1/4" + 1/2" Drive 6-Point Socket Set (Metal Case)



6.3  
1/4" 12.5  
1/2"

CODE NO	Image	Quantity
C20-35MH4		1

**C02-H** 4, 4.5, 5, 5.5, 6, 7, 8, 9, 10, 11, 12, 13 mm

**C01-14**

**C22-H** 14, 15, 16, 17, 18, 19, 21, 22, 24, 27, 30, 32 mm

**C21-14**

**C21-14**

**C01-73** 100 mm

**C21-74** 125 mm

**C01-80**

**C21-80**

**L** 1.5, 2, 2.5, 3 mm

**L/SAE** 0.05" - 1.27 mm



# 03 Sockets and Accessories

20  
3/4"

## C32-H Series

3/4" Drive 6-Point Sockets

DIN 3124, TS ISO 2725-1



20  
3/4"



CODE NO	mm	mm	
C32-H19	19	50	6
C32-H21	21	50	6
C32-H22	22	50	6
C32-H24	24	52	6
C32-H27	27	52	6
C32-H30	30	54	6
C32-H32	32	55	3
C32-H33	33	56	3
C32-H34	34	56	3
C32-H36	36	57	3
C32-H38	38	60	3
C32-H41	41	64	3
C32-H46	46	68	3
C32-H50	50	72	3
C32-H55	55	75	3
C32-H60	60	78	3

## C32A-B Series

3/4" Drive 12-Point Sockets - SAE



20  
3/4"



CODE NO	"	mm	
C32A-B11	7/8	50	6
C32A-B12	15/16	50	6
C32A-B13	1	51	6
C32A-B14	1-1/16	52	6
C32A-B15	1-1/8	52	6
C32A-B17	1-1/4	54	3
C32A-B27	1-7/8	70	3

## C31-12-2

3/4" Drive Quick Release Reversible Ratchet

DIN 3122, TS ISO 3315

new



20  
3/4"



24-tooth strong mechanism, switch pawl, knurled grip

CODE NO	mm	mm	
C31-12-2	63	500	3

## C32-B Series

3/4" Drive 12-Point Sockets

DIN 3124, TS ISO 2725-1



20  
3/4"



CODE NO	mm	mm	
C32-B22	22	50	6
C32-B24	24	50	6
C32-B27	27	52	6
C32-B30	30	54	6
C32-B32	32	56	3
C32-B36	36	58	3
C32-B38	38	60	3
C32-B41	41	64	3
C32-B46	46	68	3
C32-B50	50	73	3

## C38S-H Series

3/4" Drive Hexagon Socket Bits



20  
3/4"



CODE NO	mm	mm	
C38S-H14	14	80	6
C38S-H17	17	80	6
C38S-H19	19	80	6
C38S-H22	22	80	6

## C31-14

3/4" Drive Reversible Ratchet

DIN 3122, TS ISO 3315



20  
3/4"



48-tooth robust mechanism, switch disc, knurled grip

CODE NO	mm	mm	
C31-14	69	495	3



## C31-12

3/4" Drive Quick Release Reversible Ratchet

DIN 3122, TS ISO 3315

limited with stocks



20  
3/4"



24-tooth strong mechanism, switch pawl, knurled grip

CODE NO	mm	mm	
C31-12	63	505	3

20  
3/4"

**C31-R Series**

Ratchet Renewal Kits

CODE NO	
C31-12R (for C31-12)	1



C31-12-2R (for C31-12-2)	1
--------------------------	---



C31-14R (for C31-14)	1
----------------------	---



**C31-91**

3/4" Drive Socket Adaptor - F:3/4" M:1/2"

DIN 3123, ISO 3316



CODE NO			mm	
C31-91	3/4	1/2	54	6

**C31-70 Series**

3/4" Drive Extension Bars

DIN 3123, ISO 3316



CODE NO	mm	
C31-73	100 - 4"	6
C31-76	200 - 8"	6
C31-78	400 - 16"	6

**C31-40**

3/4" Drive Sliding T-Handle

DIN 3122, TS ISO 3315



CODE NO	mm	
C31-40	500	3

**C31-92**

3/4" Drive Socket Adaptor - F:3/4" M:1"

DIN 3123, ISO 3316



CODE NO			mm	
C31-92	3/4	1	63	6

**C30-14MH4**

14 Piece 3/4" 6-Point Socket Set



 20  
3/4"

CODE NO	
C30-14MH4	1



**C30-14MB4**

14 Piece 3/4" Drive 12-Point Socket Set



 20  
3/4"

CODE NO	
C30-14MB4	1

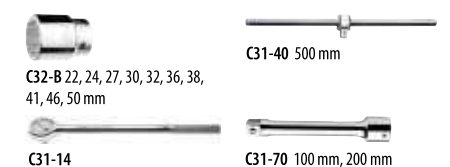

# 03 Sockets and Accessories

25  
1"

## C42-B Series

1" Drive 12-Point Sockets

DIN 3124, TS ISO 2725-1



25  
1"



CODE NO	mm	mm	
C42-B32	32	63	3
C42-B36	36	65	3
C42-B41	41	70	3
C42-B46	46	70	3
C42-B50	50	75	3
C42-B55	55	80	1
C42-B60	60	82	1
C42-B65	65	87	1
C42-B70	70	94	1
C42-B75	75	100	1
C42-B80	80	103	1

## C41-12

1" Drive Reversible Ratchet



25  
1"



24-tooth strong mechanism, switch pawl

CODE NO	mm	mm	
C41-12	70	675	1

## C41-12/H

1" Drive Reversible Ratchet (Head Only)

25  
1"



For use with C41-12/T tommy bar

CODE NO	mm	mm	
C41-12/H	70	200	1

## C41-12/T

Tommy Bar (for C41-12)



Push-fit bar handle for use with C41-12/H ratchet head, with locking pin

CODE NO	mm	
C41-12/T	550	1

## C41-12R

Ratchet Renewal Kit (for C41-12)



CODE NO	
C41-12R	1

## C41-70 Series

1" Drive Extension Bars

DIN 3123, ISO 3316

25  
1"



CODE NO	mm	
C41-76	200 - 8"	1
C41-78	400 - 16"	1

## C41-40

1" Drive Sliding T-Handle

DIN 3122, TS ISO 3315

25  
1"



CODE NO	mm	
C41-40	550	1

## C41-40R

1" Square Drive (for C41-40)

25  
1"



CODE NO	
C41-40R	1

## C41-91

1" Drive Socket Adaptor

DIN 3123, ISO 3316

20  
3/4"



25  
1"

CODE NO	"	mm	
C41-91	1 - 3/4	64	3

## C40-15MH2

15 Piece 1" 12-Point Socket Set



25  
1"

CODE NO	
C40-15MH2	1



C42-B 36, 41, 46, 50, 55, 60, 65, 70, 75, 80 mm



C41-12/T 545 mm



C41-40R



C41-12/H 200 mm



C41-70 200 mm, 400 mm

6.3  
1/4"

10  
3/8"



# Impact Sockets and Accessories

6.3  
1/4"

10  
3/8"

12.5  
1/2"

20  
3/4"

25  
1"

Impact sockets are manufactured from Chrome-Vanadium-Molybdenum steel in a thicker wall profile. Therefore, they are fit for use with high torque air tools.



## C52-H Series

1/4" Drive 6-Point Impact Sockets

DIN 3129, TS ISO 2725-2



6.3  
1/4"



CODE NO	mm	mm	
C52-H06	6	25	6•
C52-H07	7	25	6•
C52-H08	8	25	6•
C52-H13	13	25	6•
For display carded delivery = Item code + X			6

## C52R-H Series

3/8" Drive 6-Point Impact Sockets

DIN 3129, TS ISO 2725-2



10  
3/8"



CODE NO	mm	mm	
C52R-H08	8	30	6•
C52R-H10	10	30	6•
C52R-H11	11	30	6•
C52R-H12	12	30	6•
C52R-H13	13	30	6•
C52R-H14	14	30	6•
C52R-H15	15	30	6•
C52R-H16	16	30	6•
C52R-H17	17	30	6•
C52R-H18	18	30	6•
C52R-H19	19	30	6•
For display carded delivery = Item code + X			6

## C52R-RH10

10 Piece 3/8" Drive 6-Point Impact Socket Set

new



10  
3/8"



CODE NO	
C52R-RH10	6
10 PC: 10, 11, 12, 13, 14, 15, 16, 17, 18, 19 mm	

## C51R-72

3/8" Drive Impact Extension Bars



10  
3/8"



CODE NO	mm	
C51R-72	75 - 3"	6
For display carded delivery = Item code + X		6

## C51R-80

3/8" Drive Impact Universal Joint



10  
3/8"



CODE NO	mm	
C51R-80	50	6
For display carded delivery = Item code + X		6

## C51R-91

3/8" Drive Impact Socket Adaptor - F:3/8" M:1/4"



6.3  
1/4"



10  
3/8"

CODE NO	"	mm	
C51R-91	3/8 - 1/4	32	6•
For display carded delivery = Item code + X			6

## C51R-92

3/8" Drive Impact Socket Adaptor - F:3/8" M:1/2"



12.5  
1/2"



10  
3/8"

CODE NO	"	mm	
C51R-92	3/8 - 1/2	36	6•
For display carded delivery = Item code + X			6



# 03 Sockets and Accessories

12.5  
1/2"



## C62-H Series 1/2" Drive 6-Point Impact Sockets

DIN 3129, TS ISO 2725-2

12.5  
1/2"



CODE NO	mm	mm	
C62-H10	10	38	6
C62-H11	11	38	6
C62-H12	12	38	6
C62-H13	13	38	6
C62-H14	14	38	6
C62-H15	15	38	6
C62-H16	16	38	6
C62-H17	17	38	6
C62-H18	18	38	6
C62-H19	19	38	6
C62-H21	21	38	6
C62-H22	22	38	6
C62-H23	23	38	6
C62-H24	24	38	6
C62-H27	27	42	6
C62-H30	30	42	6
C62-H32	32	44	6
C62-H36	36	48	6
For display carded delivery = Item code + X			6



## C64-H Series 1/2" Drive 6-Point Impact Deep Sockets

DIN 3129, TS ISO 2725-2

12.5  
1/2"



Ideal for long threaded bolts

CODE NO	mm	mm	
C64-H10	10	78	6
C64-H11	11	78	6
C64-H12	12	78	6
C64-H13	13	78	6
C64-H14	14	78	6
C64-H15	15	78	6
C64-H16	16	78	6
C64-H17	17	78	6
C64-H18	18	78	6
C64-H19	19	78	6
C64-H21	21	78	6
C64-H22	22	78	6
C64-H23	23	78	6
C64-H24	24	78	6
C64-H27	27	78	6
C64-H30	30	78	6
C64-H32	32	78	6
For display carded delivery = Item code + X			6



## C62-B Series 1/2" Drive 12-Point Impact Sockets

DIN 3129, TS ISO 2725-2

12.5  
1/2"



CODE NO	mm	mm	
C62-B24	24	38	6
C62-B30	30	42	6
C62-B32	32	44	6
C62-B34	34	42	6
C62-B36	36	48	6
For display carded delivery = Item code + X			6



## C66-E Series 1/2" Drive E-TORX Impact Sockets

For external TORX screws

CODE NO		mm	
C66-E10	E10	38	6
C66-E12	E12	38	6
C66-E14	E14	38	6
C66-E16	E16	38	6
C66-E18	E18	38	6
C66-E20	E20	38	6
C66-E22	E22	38	6
C66-E24	E24	38	6
For display carded delivery = Item code + X			6

12.5  
1/2"



## C62-RH09 9 Piece 1/2" Drive 6-Point Impact Socket Set

ex code C62-R09

12.5  
1/2"



CODE NO	
C62-RH09	6
9 PC: 10, 11, 12, 13, 14, 17, 19, 21, 22 mm	



## C64-RH09 9 Piece 1/2" Drive 6-Point Impact Deep Socket Set

ex code C64-R09

12.5  
1/2"



CODE NO	
C64-RH09	6
9 PC: 10, 11, 12, 13, 14, 17, 19, 21, 22 mm	



## C66-R08 8 Piece 1/2" Drive E-TORX Impact Socket Set

new

12.5  
1/2"



CODE NO	
C66-R08	6
8 PC: E10, E12, E14, E16, E18, E20, E22, E24	



12.5  
1/2"



**C68-T Series**  
1/2" Drive Impact TORX Socket Bits



12.5  
1/2"



CODE NO		mm	
C68-T30	T30	78	6•
C68-T40	T40	78	6•
C68-T45	T45	78	6•
C68-T50	T50	78	6•
C68-T55	T55	78	6•
C68-T60	T60	78	6•
C68-T70	T70	78	6•
C68-T80	T80	78	6•
	For display carded delivery = Item code + X		6

**C68-H Series**  
1/2" Drive Impact Hexagon Socket Bits



12.5  
1/2"



CODE NO	mm	mm	
C68-H05	5	78	6•
C68-H06	6	78	6•
C68-H07	7	78	6•
C68-H08	8	78	6•
C68-H10	10	78	6•
C68-H12	12	78	6•
C68-H14	14	78	6•
C68-H17	17	78	6•
C68-H19	19	78	6•
	For display carded delivery = Item code + X		6

**C68-X Series**  
1/2" Drive Impact XZN Socket Bits



12.5  
1/2"



CODE NO		mm		
C68-X06	M06	78	6	6
C68-X08	M08	78	6	6
C68-X10	M10	78	6	6
C68-X12	M12	78	6	6
C68-X14	M14	78	6	6
C68-X16	M16	78	6	6
C68-X18	M18	78	6	6
	For display carded delivery = Item code + X			6

**C68-RT07**  
7 Piece 1/2" Drive Impact TORX Socket Bit Set



12.5  
1/2"



CODE NO	
C68-RT07	1
7 PC: T30, T40, T45, T50, T55, T60, T70	

**C68-RH07**  
7 Piece 1/2" Drive Impact Hexagon Socket Bit Set



12.5  
1/2"



CODE NO	
C68-RH07	1
7 PC: 5, 6, 8, 10, 12, 14, 17 mm	

**C68-RX07**  
7 Piece 1/2" Drive Impact XZN Socket Bit Set



12.5  
1/2"



CODE NO	
C68-RX07	1
7 PC: M6, M8, M10, M12, M14, M16, M18	



# 03 Sockets and Accessories

12.5  
1/2"



## C61-70 Series 1/2" Drive Impact Extension Bars



12.5  
1/2"



CODE NO	mm	
C61-72	75 - 3"	6
C61-74	125 - 5"	6
For display carded delivery = Item code + X		6

## C61-80 1/2" Drive Impact Universal Joint



12.5  
1/2"



CODE NO	mm	
C61-80	63	6
For display carded delivery = Item code + X		6

## C61-91 1/2" Drive Impact Socket Adaptor - F:1/2" M:3/8"



10  
3/8"



12.5  
1/2"

CODE NO	"	mm	
C61-91	1/2 - 3/8	38	6
For display carded delivery = Item code + X			6

## C61-92 1/2" Drive Impact Socket Adaptor - F:1/2" M:3/4"



20  
3/4"



12.5  
1/2"

CODE NO	"	mm	
C61-92	1/2 - 3/4	48	6
For display carded delivery = Item code + X			6

## BT/8000QR Series 1/2" Drive Quick Release Impact Bit Holders



For 5/16" and 10 mm bits, quick release, Chrome Vanadium Molybdenum steel, phosphate finish



12.5  
1/2"



CODE NO	mm	mm	
BT/8007QR	5/16"	54	6
BT/8008QR	10 mm	54	6

20  
3/4"



## C72-H Series 3/4" Drive 6-Point Impact Sockets



DIN 3129, TS ISO 2725-2



20  
3/4"



CODE NO	mm	mm	
C72-H17	17	51	3
C72-H19	19	51	3
C72-H21	21	51	3
C72-H22	22	51	3
C72-H24	24	51	3
C72-H27	27	54	3
C72-H30	30	54	3
C72-H32	32	57	3
C72-H33	33	57	3
C72-H34	34	57	3
C72-H36	36	57	3
C72-H38	38	57	3
C72-H41	41	58	3
C72-H46	46	63	3
C72-H50	50	68	3
C72-H55	55	73	3
C72-H60	60	75	3

## C74-H Series 3/4" Drive 6-Point Impact Deep Sockets



20  
3/4"



Ideal for long threaded bolts

CODE NO	mm	mm	
C74-H17	17	90	3
C74-H19	19	90	3
C74-H21	21	90	3
C74-H22	22	90	3
C74-H24	24	90	3
C74-H27	27	90	3
C74-H30	30	90	3
C74-H32	32	90	3
C74-H33	33	90	3
C74-H34	34	90	3
C74-H36	36	90	3
C74-H38	38	90	3
C74-H41	41	90	3
C74-H46	46	90	3
C74-H50	50	90	3

20  
3/4"



25  
1"



**C71-70 Series**

3/4" Drive Impact Extension Bars



20  
3/4"

CODE NO	mm "	
C71-75	175 - 7"	3
C71-77	250 - 10"	3

**C71-80**

3/4" Drive Impact Universal Joint



20  
3/4"

CODE NO	mm	
C71-80	90	3

**C71-91**

3/4" Drive Impact Socket Adaptor - F:3/4" M:1/2"



12.5  
1/2"

20  
3/4"

Unique replaceable square drive design

CODE NO	"	mm	
C71-91	3/4 - 1/2	58	3

**C71-91R**

1/2" Spare Square Drive (for C71-91)



12.5  
1/2"

CODE NO	
C71-91R	6

**C71-92**

3/4" Drive Impact Socket Adaptor - F:3/4" M:1"



25  
1"

20  
3/4"

CODE NO	"	mm	
C71-92	3/4 - 1	63	3

**C82-H Series**

1" Drive 6-Point Impact Sockets



DIN 3129, TS ISO 2725-2



25  
1"



CODE NO	mm	mm	
C82-H24	24	58	1
C82-H27	27	58	1
C82-H30	30	60	1
C82-H32	32	62	1
C82-H33	33	62	1
C82-H34	34	62	1
C82-H36	36	65	1
C82-H38	38	65	1
C82-H41	41	68	1
C82-H46	46	72	1
C82-H50	50	75	1
C82-H55	55	83	1
C82-H60	60	87	1
C82-H65	65	90	1
C82-H70	70	93	1
C82-H75	75	95	1
C82-H80	80	95	1

**C84-H Series**

1" Drive 6-Point Impact Deep Sockets



25  
1"



Ideal for long threaded bolts

CODE NO	mm	mm	
C84-H24	24	90	1
C84-H27	27	90	1
C84-H30	30	90	1
C84-H32	32	90	1
C84-H33	33	90	1
C84-H34	34	90	1
C84-H36	36	90	1
C84-H38	38	95	1
C84-H41	41	95	1
C84-H46	46	95	1
C84-H50	50	100	1
C84-H55	55	105	1
C84-H60	60	110	1
C84-H65	65	115	1
C84-H70	70	120	1
C84-H75	75	135	1
C84-H80	80	135	1

**C81-70 Series**

1" Drive Impact Extension Bars



25  
1"

CODE NO	mm "	
C81-75	175 - 7"	1
C81-77	250 - 10" <b>ex code C81-78</b>	1

**C81-91**

1" Drive Impact Socket Adaptor



20  
3/4"

25  
1"

CODE NO	"	mm	
C81-91	1 - 3/4	70	1



# 4

## Torque Wrenches



# 04 Torque Wrenches

## Exacto Torque Wrenches

Torque-controlled tightening is now essential in many sectors including automotive, aviation, energy etc. Our range of tools dedicated to torque controlled tightening precisely addresses the requirements of professionals in these industries.

**6.3**  
**1/4"**

**10**  
**3/8"**

**12.5**  
**1/2"**

All Ceta Form torque tools are factory calibrated according to standards and an individual serial numbered calibration certificate is provided.

Accuracy according to:  
**DIN ISO 6789 & ASME B107.14M-2004.**



**±3 %**

Individual calibration certificate



### EXTENSIONS & ADAPTERS

When using an extension or adapter (increasing the effective length of the torque wrench) the output torque value will change. To calculate the new torque output of the wrench use the following formula

$$A = \frac{L + C}{L} \times B$$

- A= Torque exerted at end of adapter
- L= Distance between square drive and hand position
- B= Wrench scale reading
- C= Length of adapter or extension

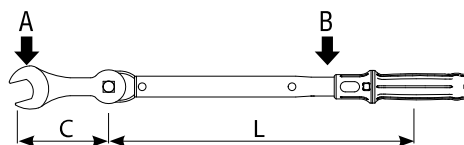

A number of variables including the length of the adapter or extension, length of the wrench and variations in hand position on the wrench will affect the accuracy of the above calculation.

# Click Type Torque Wrenches and Inserts

## D02F Series

Exacto Torque Wrenches (Window Scaled)

DIN/EN ISO 6789



YouTube Clip

Click type with reversible ratchet (45-tooth), Nm / lbf.ft window scale, push-lock scale setting, supplied in plastic case

**Individual calibration certificate to DIN ISO 6789**

CODE NO	Nm	"	mm	
D02F-0125	5 - 25	1/4	290	1
D02F-1105	10 - 50	3/8	360	1
D02F-1110	20 - 100	3/8	405	1
D02F-2110	20 - 100	1/2	405	1
D02F-2120	40 - 200	1/2	500	1
D02F-2130	60 - 300	1/2	595	1

## D02F-R Series

Ratchet Renewal Kits (for D02F Series)



YouTube Clip

CODE NO	"	
D02F-01R	1/4"	1
D02F-11R	3/8"	1
D02F-21R	1/2"	1

## D02E Serisi

Exacto Insert Torque Wrenches

DIN/EN ISO 6789



Rectangular drive for insert tools, Nm / lbf.ft window scale, push-lock scale setting, supplied in plastic case

**Individual calibration certificate to DIN ISO 6789**

CODE NO	Nm	mm	mm	
D02E-0910	20 - 100	9x12	380	1
D02E-1420	40 - 200	14x18	475	1
D02E-1430	60 - 300	14x18	570	1

## D02E-RH09 Series

Insert Reversible Ratchets (9x12)

new

9x12



24-tooth strong mechanism, switch pawl, square according to DIN 3120, ISO 1174-1

CODE NO	"	mm	
D02E-RH0938	3/8	56	1
D02E-RH0912	1/2	69	1

## D02E-OE09 Series

Insert Open End Wrenches (9x12)

new

9x12



CODE NO	mm	mm	
D02E-OE0908	8	17.5	1
D02E-OE0910	10	17.5	1
D02E-OE0911	11	17.5	1
D02E-OE0912	12	17.5	1
D02E-OE0913	13	17.5	1
D02E-OE0914	14	20	1
D02E-OE0915	15	20	1
D02E-OE0916	16	20	1
D02E-OE0917	17	20	1
D02E-OE0918	18	20	1
D02E-OE0919	19	20	1

## D02E-RE09 Series

Insert Ring End Wrenches (9x12)

new

9x12



CODE NO	mm	mm	
D02E-RE0908	8	17.5	1
D02E-RE0910	10	17.5	1
D02E-RE0911	11	17.5	1
D02E-RE0912	12	17.5	1
D02E-RE0913	13	17.5	1
D02E-RE0914	14	17.5	1
D02E-RE0915	15	17.5	1
D02E-RE0916	16	17.5	1
D02E-RE0917	17	17.5	1
D02E-RE0918	18	17.5	1
D02E-RE0919	19	17.5	1
D02E-RE0922	22	17.5	1

## D02E-RH1412

1/2" Drive Insert Reversible Ratchet (14x18)

new

14x18



24-tooth strong mechanism, switch pawl, square according to DIN 3120, ISO 1174-1

CODE NO	"	mm	
D02E-RH1412	1/2	78	1

## D02E-OE14 Series

Insert Open End Wrenches (14x18)

new

14x18



CODE NO	mm	mm	
D02E-OE1413	13	25	1
D02E-OE1414	14	25	1
D02E-OE1415	15	25	1
D02E-OE1416	16	25	1
D02E-OE1417	17	25	1
D02E-OE1418	18	25	1
D02E-OE1419	19	25	1
D02E-OE1421	21	25	1
D02E-OE1422	22	25	1
D02E-OE1424	24	25	1
D02E-OE1427	27	31.5	1
D02E-OE1430	30	31.5	1
D02E-OE1432	32	31.5	1

## D02E-RE14 Series

Insert Ring End Wrenches (14x18)

new

14x18



CODE NO	mm	mm	
D02E-RE1413	13	25	1
D02E-RE1414	14	25	1
D02E-RE1415	15	25	1
D02E-RE1416	16	25	1
D02E-RE1417	17	25	1
D02E-RE1418	18	25	1
D02E-RE1419	19	25	1
D02E-RE1421	21	25	1
D02E-RE1422	22	25	1
D02E-RE1424	24	25	1
D02E-RE1427	27	31	1
D02E-RE1430	30	31	1
D02E-RE1432	32	31	1

# 04 Torque Wrenches

## Torque Wrenches and Angle Gauges

### D03F Serisi

3/4" Drive Duo Torque Wrenches (Etch Scaled)

DIN/EN ISO 6789

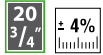

Click type with reversible ratchet (48-tooth), Nm / lbf.ft etch scale, CW/CCW direction, pull down chuck scale setting/locking, supplied in plastic case

**Individual calibration certificate to DIN ISO 6789**

CODE NO	Nm	mm	
D03F-3155	110-550	918	1
D03F-3175	150-750	1125	1
D03F-3110	200-1000	1200	1

### D03F-31R

Ratchet Renewal Kit (for D03F-31 Series)



YouTube Clip

CODE NO		
D03F-31R	3/4"	1

### D06-21

1/2" Drive Torque Angle Gauge



For angle controlled tightening with 1/2" torque wrenches

CODE NO	mm	
D06-21	52	1

### D03-21 Series

1/2" Drive CLASSIC Torque Wrenches

DIN/EN ISO 6789

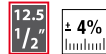

Click type with fixed square drive, Nm / kgf.m / lbf.ft / lbf.in etch scale, supplied in plastic case

**Individual calibration certificate to DIN ISO 6789**

CODE NO	Nm	mm	
D03-2114	25 - 135	556	1
D03-2123	50 - 225	585	1
D03-2133	70 - 330	805	1

### D03-21R

Spare Square Drive (for D03-21 Series)



CODE NO		
D03-21R	6 *	1

### D06-31

3/4" Drive Torque Angle Gauge



For angle controlled tightening with 3/4" torque wrenches

CODE NO	mm	
D06-31	90	1

## Torque Multipliers

### D20-P Series

Torque Multiplier Sets



YouTube Clip

For reducing the effort needed to apply high torque, planetary gear mechanism, supplied with 2 reaction arm styles for maximum versatility

**P2131 max input: 500 Nm max output: 1.500 Nm**

**P3141 max input: 1.000 Nm max output: 3.000 Nm**

CODE NO		
D20-P2131	1/2 - 3/4	1
D20-P3141	3/4 - 1	1

### D20HR Series

Torque Multipliers (High Ratio)

**new**



Double planetary-gear-carriers allow for high load capacity. With high ratio gearbox up to 26:1, multiplication accuracy  $\pm 5\%$ . High ratios ideal for replacing long lever arms and heavy wrenches. Supplied with 2 different reaction bars. Anti-backlash mechanism for safety and comfortable operation.

CODE NO	MAX RATED OUTPUT (Nm)		
D20HR-300	3000	1/2 - 1	1
D20HR-450	4500	1/2 - 1	1

Max Rated Input:

D20HR-300: 200 Nm (Ratio: 15.5:1)

D20HR-450: 180 Nm (Ratio: 26:1)



Max Rated Output:

D20HR-300: (Ratio: 15.5:1)

D20HR-450: (Ratio: 26:1)

# 5



## Screwdrivers and Bits





# C-PLUS Screwdrivers

## F14 Series

C-PLUS Phillips Screwdrivers

DIN ISO 8764-1, TS 59-5



CODE NO	+	mm		
F14-000-060	PH0	60		12
F14-000-080	PH0	80		12
F14-001-080	PH1	80		12
F14-001-100	PH1	100		12
F14-001-125	PH1	125		12
F14-001-200	PH1	200		12
F14-002-100	PH2	100		12
F14-002-125	PH2	125		12
F14-002-150	PH2	150		12
F14-002-200	PH2	200		12
F14-003-150	PH3	150		12
F14-004-200	PH4	200		12

## F14-300 Series

C-PLUS Phillips Screwdrivers (Extra Long Shaft)

DIN ISO 8764-1, TS 59-5



CODE NO	+	mm		
F14-001-300	PH1	300		12
F14-002-300	PH2	300		12

## F15 Series

C-PLUS Phillips Screwdrivers (with Hex Bolster)

DIN ISO 8764-1, TS 59-5



Hex bolster for increased torque

CODE NO	+	mm	mm	
F15-001-080	PH1	80	8	12
F15-002-100	PH2	100	10	12
F15-003-150	PH3	150	13	12

## F16 Series

C-PLUS Stubby Phillips Screwdrivers

DIN ISO 8764-1, TS 59-5



Stubby design ideal for tight spaces

CODE NO	+	mm		
F16-001-025	PH1	25		12
F16-002-025	PH2	25		12

## F17 Series

C-PLUS Pozidriv Screwdrivers

DIN ISO 8764-1, TS 59-5



CODE NO	+	mm		
F17-000-060	PZ0	60		12
F17-001-080	PZ1	80		12
F17-002-100	PZ2	100		12
F17-002-125	PZ2	125		12
F17-003-150	PZ3	150		12
F17-004-200	PZ4	200		12

## F17 Series / TP

C-PLUS Stubby Pozidriv Screwdrivers

DIN ISO 8764-1, TS 59-5



Stubby design ideal for tight spaces

CODE NO	+	mm		
F17-001-025	PZ1	25		12
F17-002-025	PZ2	25		12

## F18 Series

C-PLUS TORX Screwdrivers



CODE NO		mm		
F18-005-060	T5	60		12
F18-006-060	T6	60		12
F18-007-060	T7	60		12
F18-008-060	T8	60		12
F18-009-060	T9	60		12
F18-010-080	T10	80		12
F18-015-080	T15	80		12
F18-020-100	T20	100		12
F18-025-100	T25	100		12
F18-027-115	T27	115		12
F18-030-115	T30	115		12
F18-040-130	T40	130		12
F18-045-130	T45	130		12

## F18-300 Series

C-PLUS TORX Screwdrivers (Extra Long Shaft)



CODE NO		mm		
F18-015-300	T15	300		12
F18-020-300	T20	300		12
F18-025-300	T25	300		12
F18-030-300	T30	300		12

## F19 Series

C-PLUS TORX Tamper Proof Screwdrivers

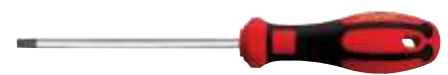

For TORX screws with safety pin

CODE NO		mm		
F19-010-080	T10	80		12
F19-015-080	T15	80		12
F19-020-100	T20	100		12
F19-025-100	T25	100		12
F19-027-115	T27	115		12
F19-030-115	T30	115		12
F19-040-130	T40	130		12



# 05 Screwdrivers and Bits

## C-PLUS Screwdrivers

### F20 Series

C-PLUS Nut Drivers

DIN 3125, ISO 2236, TS 3793



25 mm deep hexagon socket for long threaded bolts

CODE NO	mm	mm	
F20-040-125	4	125	12
F20-050-125	5	125	12
F20-055-125	5.5	125	12
F20-060-125	6	125	12
F20-070-125	7	125	12
F20-080-125	8	125	12
F20-090-125	9	125	12
F20-100-125	10	125	12
F20-110-125	11	125	12
F20-120-125	12	125	12
F20-130-125	13	125	12
F20-140-125	14	125	12

### F20A Series

C-PLUS Nut Drivers - SAE



25 mm deep hexagon socket for long threaded bolts

CODE NO	inch	mm	
F20A-0104	1/4	125	12
F20A-0516	5/16	125	12
F20A-0308	3/8	125	12

### F21 Series

C-PLUS Nut Drivers (Flexible Shaft)



Flexible shaft design for tight spaces

CODE NO	mm	mm	
F21-050-150	5	150	12
F21-060-150	6	150	12
F21-070-150	7	150	12
F21-080-150	8	150	12
F21-100-150	10	150	12

### F22 Series

C-PLUS Hexagon Screwdrivers



CODE NO	mm	mm	
F22-020-100	2	100	12
F22-025-100	2.5	100	12
F22-030-100	3	100	12
F22-040-100	4	100	12
F22-050-100	5	100	12
F22-060-125	6	125	12
F22-080-150	8	150	12
F22-100-150	10	150	12

### F22A Series

C-PLUS Hexagon Screwdrivers - SAE

new



CODE NO	inch	mm	
F22A-0050	0.05*	60	12
F22A-0116	1/16	60	12
F22A-0564	5/64	60	12
F22A-0332	3/32	80	12
F22A-0764	7/64	80	12
F22A-0108	1/8	80	12
F22A-0964	9/64	80	12
F22A-0532	5/32	100	12
F22A-0316	3/16	100	12

\*0.05 inch = 1.27 mm

### F24 Series

C-PLUS Square Screwdrivers



For square socket (Robertson) screws

CODE NO		mm	
F24-001-100	No.1	100	12
F24-002-125	No.2	125	12
F24-003-150	No.3	150	12

### F23 Series

C-PLUS Ball End Hexagon Screwdrivers



Ball end allows up to 25° entry

CODE NO	mm	mm	
F23-020-100	2	100	12
F23-025-100	2.5	100	12
F23-030-100	3	100	12
F23-040-100	4	100	12
F23-050-100	5	100	12
F23-060-125	6	125	12
F23-080-150	8	150	12
F23-100-150	10	150	12

### F23A Series

C-PLUS Ball End Hexagon Screwdrivers - SAE

new



Ball end allows up to 25° entry

CODE NO	inch	mm	
F23A-0532	5/32	100	12
F23A-0316	3/16	100	12
F23A-0732	7/32	100	12
F23A-0104	1/4	125	12
F23A-0516	5/16	150	12
F23A-0308	3/8	150	12

### F25 Series

C-PLUS TRI-WING Screwdrivers



For TRI-WING screws

CODE NO		mm	
F25-002-080	TW2	80	12
F25-003-080	TW3	80	12
F25-004-100	TW4	100	12
F25-005-100	TW5	100	12

# C-PLUS Screwdriver Sets

## F99-403

4 Piece C-PLUS Screwdriver Set - Phillips

 x4



CODE NO

F99-403



1

 F14 PH0x60, PH1x80, PH2x100, PH3x150 mm

## F99-403P

4 Piece C-PLUS Screwdriver Set - Pozidriv

 x4



CODE NO

F99-403P



1

 F17 PZ0x60, PZ1x80, PZ2x100, PZ3x150 mm

## F99-405

4 Piece C-PLUS Screwdriver Set (Extra Long Shaft) - TORX

 x4

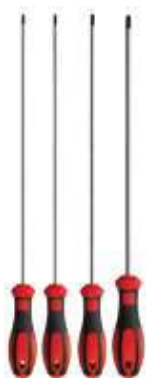

CODE NO

F99-405



1

 F18 T15x300, T20x300, T25x300, T30x300 mm

**new**

## F99-501

5 Piece C-PLUS Screwdriver Set - Slotted/Phillips

 x3

 x2





CODE NO

F99-501



1

 F10 2.5x75, 4.0x100, 5.5x125 mm  
 F14 PH1x80, PH2x100 mm

## F99-501P

5 Piece C-PLUS Screwdriver Set - Slotted/Pozidriv

 x3

 x2





CODE NO

F99-501P



1

 F10 2.5x75, 4.0x100, 5.5x125 mm  
 F17 PZ1x80, PZ2x100 mm

## F99-502

5 Piece C-PLUS Screwdriver Set - Slotted

 x5



CODE NO

F99-502



1

 F10 3.0x75, 4.0x100, 5.5x125, 6.5x150, 8.0x150 mm

## F20-B05

5 Piece C-PLUS Nut Driver Set

 x5



CODE NO

F20-B05



1

 F20 6x125, 7x125, 8x125, 10x125, 13x125 mm

## F99-601

6 Piece C-PLUS Screwdriver Set - Slotted/Phillips

 x4

 x2





CODE NO

F99-601



1

 F10 3.0x75, 4.0x100, 5.5x125, 6.5x150 mm  
 F14 PH1x80, PH2x100 mm

## F99-602

6 Piece C-PLUS Screwdriver Set - Slotted/Pozidriv

 x4

 x2





CODE NO

F99-602



1

 F10 3.0x75, 4.0x100, 5.5x125, 6.5x150 mm  
 F17 PZ1x80, PZ2x100 mm

# 05 Screwdrivers and Bits

## C-PLUS Screwdriver Sets

### F99-605

6 Piece C-PLUS Screwdriver Set - TORX



x6



CODE NO	
F99-605	1

F18 T10x80, T15x80, T20x100, T25x100, T30x115, T40x130 mm

### F99-606

6 Piece C-PLUS Screwdriver Set - TORX Tamper Proof



x6



CODE NO	
F99-606	1

F19 T10x80, T15x80, T20x100, T25x100, T30x115, T40x130 mm

### F99-701

7 Piece C-PLUS Screwdriver Set - Slotted/Phillips



x4

x3



CODE NO	
F99-701	1

F10 3.0x75, 4.0x100, 5.5x125, 6.5x150 mm  
 F14 PH0x60, PH1x80, PH2x100 mm

### F99-702

7 Piece C-PLUS Screwdriver Set - Slotted/Pozidriv



x4

x3



CODE NO	
F99-702	1

F10 3.0x75, 4.0x100, 5.5x125, 6.5x150 mm  
 F17 PZ0x60, PZ1x80, PZ2x100 mm

### F99-601V

7 Piece C-PLUS Screwdriver Set - Slotted/Phillips + Tester



x5

x2



CODE NO	
F99-601V	1

F10 3.0x75, 4.0x100, 5.5x125, 6.5x150 mm  
 F14 PH1x80, PH2x100 mm  
 6105CP Voltage Tester - Short

### F99-602V

7 Piece C-PLUS Screwdriver Set - Slotted/Pozidriv + Tester



x5

x2



CODE NO	
F99-602V	1

F10 3.0x75, 4.0x100, 5.5x125, 6.5x150 mm  
 F17 PZ1x80, PZ2x100 mm  
 6105CP Voltage Tester - Short

### F99-901

9 Piece C-PLUS Screwdriver Set (in Vinyl Wallet)



x5

x2

x2

CODE NO	
F99-901	1

F10 3.0x75, 4.0x100, 5.5x125, 6.5x150 mm

F17 PZ1x80, PZ2x100 mm

F14 PH1x80, PH2x100 mm

6105CP Voltage Tester - Short

### SF99 Series

C-PLUS Screwdriver Set Display Packs



CODE NO	
SF99-601	1

12x F99-601

SF99-602	1
----------	---

12x F99-602

SF99-701	1
----------	---

12x F99-701

SF99-702	1
----------	---

12x F99-702

SF99-601V	1
-----------	---

12x F99-601V

SF99-602V	1
-----------	---

12x F99-602V

# TOREX Screwdriver Programme

The Classic screwdriver series from Ceta Form has been revised with a new ergonomic handle.



Precision machined ultimate fit non-peel black finish tips

Precision hardened Chrome-Vanadium-Molybdenum steel

Refined ergonomic design and premium quality plastic materials for a comfortable grip



## 4100M Series / C

TOREX Slotted Screwdrivers (Cabinet Tip)

DIN TS ISO 2380-1, TS 59-1/3/4



CODE NO	Ømm	mm	
4100/21M	2.5	75	12
4100/31M	3.0	75	12
4100/32M	3.0	100	12
4100/35M	3.5	100	12
4100/41M	4.0	75	12
4100/42M	4.0	100	12
4100/43M	4.0	125	12
4100/44M	4.0	150	12

## 4100M Series / W

TOREX Slotted Screwdrivers (Flared Tip)

DIN TS ISO 2380-1, TS 59-1/3/4



CODE NO	Ømm	mm	
4100/52M	5.5	100	12
4100/53M	5.5	125	12
4100/54M	5.5	150	12
4100/56M	5.5	200	12
4100/62M	6.5	100	12
4100/63M	6.5	125	12
4100/64M	6.5	150	12
4100/66M	6.5	200	12
4100/74M	8.0	150	12
4100/75M	8.0	175	12
4100/86M	10.0	200	12
4100/87M	10.0	250	12
4100/107M	12.0	250	12

## 4200M Series

TOREX Phillips Screwdrivers

DIN ISO 8764-1/2, TS 59-1/5/6



CODE NO	+	mm	
4200/30M	PH0	60	12
4200/31M	PH0	80	12
4200/51M	PH1	80	12
4200/52M	PH1	100	12
4200/53M	PH1	125	12
4200/56M	PH1	200	12
4200/62M	PH2	100	12
4200/63M	PH2	125	12
4200/64M	PH2	150	12
4200/66M	PH2	200	12
4200/84M	PH3	150	12
4200/106M	PH4	200	12

## 4100M Series / TP

TOREX Stubby Slotted Screwdrivers

DIN TS ISO 2380-1/2, TS 59-1/3/4



Stubby design ideal for tight spaces

CODE NO	Ømm	mm	
4100/TP40M	4.0	25	12
4100/TP55M	5.5	25	12
4100/TP65M	6.5	25	12

## 4200M Series / TP

TOREX Stubby Phillips Screwdrivers

DIN ISO 8764-1/2, TS 59-1/5/6



Stubby design ideal for tight spaces

CODE NO	+	mm	
4200/TP1M	PH1	25	12
4200/TP2M	PH2	25	12



# 05 Screwdrivers and Bits

## TOREX Screwdrivers

### 4300M Series

TOREX Pozidriv Screwdrivers

DIN ISO 8764-1/2, TS 59-1/5/6



CODE NO	+	mm		
4300/30M	PZ0	60		12
4300/51M	PZ1	80		12
4300/62M	PZ2	100		12
4300/84M	PZ3	150		12

### 4400M Series

TOREX TORX Screwdrivers



CODE NO	T	mm		
4400/T10M	T10	80		12
4400/T15M	T15	80		12
4400/T20M	T20	100		12
4400/T25M	T25	100		12
4400/T27M	T27	115		12
4400/T30M	T30	115		12
4400/T40M	T40	130		12

### 1300M Series

TOREX Nut Drivers

DIN ISO 3125, ISO 2236, TS 3793



25 mm deep hexagon socket for long threaded bolts

CODE NO	mm	mm		
1304M	4	125		12
1305M	5	125		12
1355M	5.5	125		12
1306M	6	125		12
1307M	7	125		12
1308M	8	125		12
1309M	9	125		12
1310M	10	125		12
1311M	11	125		12
1312M	12	125		12
1313M	13	125		12
1314M	14	125		12



Chapter /1 Page 55



## TOREX Screwdriver Sets

### 4000M/4ST4

4 Piece TOREX Screwdriver Set - Phillips



CODE NO	
4000M/4ST4	1

4200M PH0x60, PH1x80, PH2x100, PH3x150 mm

### 4000M/5ST1

5 Piece TOREX Screwdriver Set - Slotted/Phillips



CODE NO	
4000M/5ST1	1

4100M 3.0x75, 4.0x100, 5.5x125 mm  
4200M PH1x80, PH2x100 mm

### 4000M/5ST3

5 Piece TOREX Screwdriver Set - Slotted



CODE NO	
4000M/5ST3	1

4100M 3.0x75, 4.0x100, 5.5x125, 6.5x150, 8.0x150 mm

### 1300M/5ST1

5 Piece TOREX Nut Driver Set



CODE NO	
1300M/5ST1	1

1300M 6x125, 7x125, 8x125, 10x125, 13x125 mm

### 4000M/6ST1

6 Piece TOREX Screwdriver Set - Slotted/Phillips



CODE NO	
4000M/6ST1	1

4100M 3.0x75, 4.0x100, 5.5x125, 6.5x150 mm  
4200M PH1x80, PH2x100 mm

### 4000M/6ST2

6 Piece TOREX Screwdriver Set - Slotted/Pozidriv



CODE NO	
4000M/6ST2	1

4100M 3.0x75, 4.0x100, 5.5x125, 6.5x150 mm  
4300M PZ1x80, PZ2x100 mm

# TOREX Screwdriver Sets

## 4400M/6ST1

6 Piece TOREX Screwdriver Set - TORX



x6



CODE NO	
4400M/6ST1	1

4400M T10x80, T15x80, T20x100, T25x100, T30x115, T40x130 mm

## 4000M/7ST1

7 Piece TOREX Screwdriver Set - Slotted/Phillips



x4

x3



CODE NO	
4000M/7ST1	1

4100M 3.0x75, 4.0x100, 5.5x125, 6.5x150 mm  
4200M PH0x60, PH1x80, PH2x100 mm

## 4000M/7ST2

7 Piece TOREX Screwdriver Set - Slotted/Pozidriv



x4

x3



CODE NO	
4000M/7ST2	1

4100M 3.0x75, 4.0x100, 5.5x125, 6.5x150 mm  
4300M PZ0x60, PZ1x80, PZ2x100 mm

## 4000M/9ST1

9 Piece TOREX Screwdriver Set (in Vinyl Wallet)



x5

x2

x2

CODE NO	
4000M/9ST1	1

4100M 3.0x75, 4.0x100, 5.5x125, 6.5x150 mm

4300M PZ1x80, PZ2x100 mm

4200M PH1x80, PH2x100 mm

6105CP Voltage Tester - Short

## S4000M/ST Series

TOREX Screwdriver Set Display Packs



CODE NO	
S4000M/6ST1	1
12x 4000M/6ST1	
S4000M/6ST2	1
12x 4000M/6ST2	
S4000M/7ST1	1
12x 4000M/7ST1	
S4000M/7ST2	1
12x 4000M/7ST2	



Chapter /15 Page 274



# 05 Screwdrivers and Bits

## Ceta Form Multi-System

The reversible screwdriver program – redesigned



- Unique telescoping design of blades allows variable blade lengths
- All reversible blades manufactured from Chrome Vanadium Molybdenum steel
- Selection of socket adaptors and bit holders also available
- 8002QH handle offers secure and quick clamping of blades



### 8000Q/M15 15 Piece Multi-System Set



CODE NO	Image	Quantity
8000Q/M15		1
8246Q 4.0/6.0 mm		
8312Q PH1/PH2		
8412Q PZ1/PZ2		
8500Q T15/T20, T25/T30		
8102Q 1/4"x175 mm		

### 8002QH C-PLUS Telescopic Handle (for Multi-System Blades)



Enables telescopic clamping of 1/4" hex Multi-System blades, secure hold, rapid blade exchange

CODE NO	Image	Quantity
8002QH		6

### 8101Q Multi-System Bit Holder (Telescopic)



For use with 1/4" bits, stainless steel holder with magnet

CODE NO	Image	Quantity
8101Q		6

### 8102Q Multi-System Socket Adaptor (Telescopic)



For use with 1/4" drive sockets, spring loaded ball bearing

CODE NO	Image	Quantity
8102Q		6

### 8246Q Multi-System Slotted Combination Blade (Telescopic)

DIN ISO 2380-1



CODE NO	Image	Quantity
8246Q		6

### 8312Q Multi-System Phillips Combination Blade (Telescopic)



CODE NO	Image	Quantity
8312Q		6

### 8412Q Multi-System Pozidriv Combination Blades (Telescopic)

DIN ISO 8764-1



CODE NO	Image	Quantity
8412Q		6

### 8500Q Series Multi-System TORX Combination Blades (Telescopic)



CODE NO	Image	Quantity
8515Q		6
8525Q		6

## Reversible Screwdrivers and Magnetizing Tool

### 8000/PH3

3 Piece Multi-System Set - Hex



CODE NO	
8000/PH3	1
8002 6x130 mm	
8800 3.0/4.0, 5.0/6.0 mm	

### FX-MD

Magnetiser / Demagnetiser



Used for magnetizing or demagnetizing screwdriver blades, hex keys and similar driving tools

CODE NO	GxYxD/mm	
FX-MD	51x49x29	25

### 3100/TF2

Reversible Screwdriver

DIN ISO 2380-1/2, DIN ISO 8764-1/2



Slotted / Phillips

CODE NO	$\varnothing$ mm	mm	
3100/TF2	PH2 / 6.0	175	12



## Offset Screwdrivers

### Z Series

Offset Slotted Screwdrivers

TS 59-2/1-2

**new**  
design



Ideal for tight spaces

CODE NO	$\varnothing$ mm	mm	
Z/40	4.0	100	12
Z/55	5.5	125	12

### Z/12

Offset Phillips Screwdriver

TS 59-2/1-2

**new**  
design



Ideal for tight spaces

CODE NO		mm	
Z/12	PH1 x PH2	100	12



1) Press sleeve to unlock blade



2) Set the desired blade length

**80-150 mm**



3) Release the sleeve to lock the blade

# 05 Screwdrivers and Bits

## Impact Driver Bits

Observing the trend towards impact screwdriving machines, Ceta Form has launched a special bit and bit holder range. This range delivers when the ultimate durability is required.



### Performance Chart

Impact use

System	Life Time

The best performance even with the strongest machines.

### CB/250TM Series

Phillips Insert Bits (Impact Grade)



CODE NO	+	mm	
CB/251TM	PH1	25	12 •
CB/252TM	PH2	25	12 •
CB/253TM	PH3	25	12 •

### CB/490TM Series

Phillips Power Bits (Impact Grade)



CODE NO	+	mm	
CB/491TM	PH1	50	12 •
CB/492TM	PH2	50	12 •
CB/493TM	PH3	50	12 •

### CB/490TM Series - XL

Phillips Power Bits (Impact Grade)- Extra Long



CODE NO	+	mm	
CB/702TM	PH2	70	12 •
CB/902TM	PH2	90	12 •

### CB/350TM Series

Pozidriv Insert Bits (Impact Grade)



CODE NO	+	mm	
CB/351TM	PZ1	25	12 •
CB/352TM	PZ2	25	12 •
CB/353TM	PZ3	25	12 •

### CB/590TM Series

Pozidriv Power Bits (Impact Grade)



CODE NO	+	mm	
CB/591TM	PZ1	50	12 •
CB/592TM	PZ2	50	12 •
CB/593TM	PZ3	50	12 •

### CB/590TM Series - XL

Pozidriv Power Bits (Impact Grade)- Extra Long



CODE NO	+	mm	
CB/712TM	PZ2	70	12 •
CB/912TM	PZ2	90	12 •

### CB/800TM Series

TORX Insert Bits (Impact Grade)

**new**



CODE NO	+	mm	
CB/806TM	T10	25	12 •
CB/807TM	T15	25	12 •
CB/808TM	T20	25	12 •
CB/809TM	T25	25	12 •
CB/811TM	T30	25	12 •
CB/812TM	T40	25	12 •

### CB/820TM Series

TORX Power Bits (Impact Grade)

**new**



CODE NO	+	mm	
CB/824TM	T10	50	12 •
CB/825TM	T15	50	12 •
CB/826TM	T20	50	12 •
CB/827TM	T25	50	12 •
CB/829TM	T30	50	12 •
CB/830TM	T40	50	12 •

### BT/01TM

Magnetic Bit Holder (Impact Grade)



CODE NO	+	mm	
BT/01TM	1/4	68	6

# Torsion Bits

Sudden torque peaks particularly during screwdriving applications on metals and hard materials cause premature bit breakage. A tough but flexible bit with a torsion zone is the answer for such applications: Ceta Form Torsion Bits.

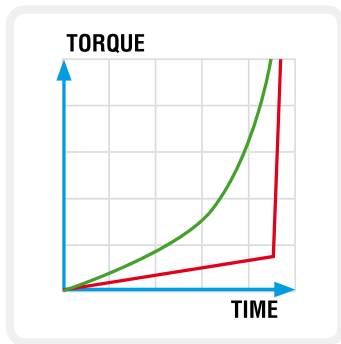

Optimized Torsion zone both in E6.3 and C6.3 profiles. Provides resistance to torsional stress and ultimately longer life time.

## CB/250DM Series

Phillips Insert Bits (Torsion)



CODE NO	+	mm	
CB/251DM	PH1	25	12 •
CB/252DM	PH2	25	12 •
CB/253DM	PH3	25	12 •

## CB/490DM Series

Phillips Power Bits (Torsion)



CODE NO	+	mm	
CB/491DM	PH1	50	12 •
CB/492DM	PH2	50	12 •
CB/493DM	PH3	50	12 •

## CB/350DM Series

Pozidriv Insert Bits (Torsion)



CODE NO	+	mm	
CB/351DM	PZ1	25	12 •
CB/352DM	PZ2	25	12 •
CB/353DM	PZ3	25	12 •

## CB/590DM Series

Pozidriv Power Bits (Torsion)



CODE NO	+	mm	
CB/591DM	PZ1	50	12 •
CB/592DM	PZ2	50	12 •
CB/593DM	PZ3	50	12 •



# 05 Screwdrivers and Bits

## CETA FORM Bits and Accessories

A complete range of industrial quality screwdriver bits. Save time and money by utilising Ceta Form high-performance driver bits.



## New Compact Set Boxes

Engineered for the highest possible number of tools in most compact dimensions. Ideal for field technicians, mechanics and engineers.

### DURABLE

Manufactured from premium quality materials. The integrated soft areas help absorb impacts protecting the box itself and the contents.

### VERSATILE

Two different box dimensions and a large number of set options offered within these boxes.

### SECURE

The tools are securely placed into their slots either within a foam module or a plastic insert.



# 1/4" Insert Bits

## CB/250 Series

Phillips Bits

DIN ISO 8764-1, TS 8748-2, DIN 3126-C 6.3, ISO 1173



CODE NO	+	mm	
CB/250	PH0	25	12 •
CB/251	PH1	25	12 •
CB/252	PH2	25	12 •
CB/253	PH3	25	12 •
CB/254	PH4	32	12 •

## CB/252D

Phillips Bit Display Pack (PH2) - 240 Pieces

**BUY MORE  
PAY LESS**



CODE NO	
CB/252D	1
240x CB/252 (PH2)	

## CB/250X Series

Phillips Bits (Display Packed)



The code represents a 3 piece package

CODE NO	+	mm	
CB/251X	PH1	25	12 packs
CB/252X	PH2	25	12 packs
CB/253X	PH3	25	12 packs

## CB/252DB

Drywall Phillips Screw Setter

DIN ISO 8764-1, TS 8748-2, DIN 3126-C 6.3, ISO 1173



Ensures precise depth control especially for drywall screws

CODE NO	+	mm	
CB/252DB	PH2	25	6 •

## CB/250B Series

Phillips Bits (in 50 pc. Packs)

**ECO  
PACK**



CODE NO	+	mm	
CB/251B	PH1	25	50 •
CB/252B	PH2	25	50 •
CB/253B	PH3	25	50 •

## CB/252BD

Phillips Bit Display Pack (PH2) - 500 Pieces

**BUY MORE  
PAY LESS**



CODE NO	
CB/252BD	1
500x CB/252B (PH2)	

## CB/262

Phillips Bit (Reduced Diameter)

DIN ISO 8764-1, TS 8748-2, DIN 3126-C 6.3, ISO 1173



CODE NO	+	mm	
CB/262	PH2	25	12 •

## CB/262B

Phillips Bit (Reduced Diameter-in 50 pc. Packs)

**ECO  
PACK**



CODE NO	+	mm	
CB/262B	PH2	25	50 •

## CB/350 Series

Pozidriv Bits

DIN ISO 8764-1, TS 8748-2, DIN 3126-C 6.3, ISO 1173



CODE NO	+	mm	
CB/350	PZ0	25	12 •
CB/351	PZ1	25	12 •
CB/352	PZ2	25	12 •
CB/353	PZ3	25	12 •
CB/354	PZ4	32	12 •

## CB/352D

Pozidriv Bit Display Pack (PZ2) - 240 Pieces

**BUY MORE  
PAY LESS**



CODE NO	
CB/352D	1
240x CB/352 (PZ2)	

## CB/350X Series

Pozidriv Bits (Display Packed)



The code represents a 3 piece package

CODE NO	+	mm	
CB/351X	PZ1	25	12 packs
CB/352X	PZ2	25	12 packs
CB/353X	PZ3	25	12 packs

# 05 Screwdrivers and Bits

## 1/4" Insert Bits

### CB/350B Series

Pozidriv Bits (in 50 pc. Packs)

**ECO PACK**



CODE NO	+	mm	Box
CB/351B	PZ1	25	50 •
CB/352B	PZ2	25	50 •
CB/353B	PZ3	25	50 •

### CB/352BD Series

Pozidriv Bit Display Pack (PZ2) - 500 Pieces

**BUY MORE PAY LESS**



CODE NO	+	Box
CB/352BD		1
<b>500x CB/352B (PZ2)</b>		

### CB/610 Series

Slotted Bits

DIN 5264-C, ISO 2380, TS 8748-1, DIN 3126-C 6.3, ISO 1173



CODE NO	mm	mm	Box
CB/611	4.0	25	12 •
CB/610	4.5	25	12 •
CB/612	5.5	25	12 •
CB/613	6.5	25	12 •

### CB/800 Series

TORX Bits

DIN 3126-C 6.3, ISO 1173



CODE NO	T	mm	Box
CB/801	T05	25	12 •
CB/802	T06	25	12 •
CB/803	T07	25	12 •
CB/804	T08	25	12 •
CB/805	T09	25	12 •
CB/806	T10	25	12 •
CB/807	T15	25	12 •
CB/808	T20	25	12 •
CB/809	T25	25	12 •
CB/810	T27	25	12 •
CB/811	T30	25	12 •
CB/812	T40	25	12 •
CB/813	T45	35	12 •
CB/814	T50	35	12 •

### CB/800X Series

TORX Bits (Display Packed)

**new**



The code represents a 3 piece package

CODE NO	T	mm	Box
CB/806X	T10	25	12 packs
CB/807X	T15	25	12 packs
CB/808X	T20	25	12 packs
CB/809X	T25	25	12 packs
CB/811X	T30	25	12 packs
CB/812X	T40	25	12 packs

### CB/800T Series

TORX Tamper Proof Bits

DIN 3126-C 6.3, ISO 1173



for TORX screws with safety pin

CODE NO	T	mm	Box
CB/806T	T10	25	12 •
CB/807T	T15	25	12 •
CB/808T	T20	25	12 •
CB/809T	T25	25	12 •
CB/810T	T27	25	12 •
CB/811T	T30	25	12 •
CB/812T	T40	25	12 •

### CB/800B Series

TORX Bits (in 50 pc. Packs)

**ECO PACK**



CODE NO	T	mm	Box
CB/806B	T10	25	50 •
CB/807B	T15	25	50 •
CB/808B	T20	25	50 •
CB/809B	T25	25	50 •
CB/811B	T30	25	50 •

### CB/800BD Series

TORX Bit Display Packs - 500 Pieces

**BUY MORE PAY LESS**



CODE NO	T	Box
CB/808BD		1
<b>500x CB/808B (T20)</b>		
CB/811BD		1
<b>500x CB/811B (T30)</b>		

### CB/800IP Series

TORX PLUS Bits

DIN 3126-C 6.3, ISO 1173



CODE NO	T	mm	Box
CB/806IP	IP10	25	12 •
CB/807IP	IP15	25	12 •
CB/808IP	IP20	25	12 •
CB/809IP	IP25	25	12 •
CB/811IP	IP30	25	12 •
CB/812IP	IP40	25	12 •

# 1/4" Insert Bits

## CB/800IPR Series

TORX IPR Bits  
DIN 3126-C 6.3, ISO 1173



Especially for ECU, air conditioning and fuel injection pump applications in automotive

CODE NO		mm	
CB/806IPR	IPR10	25	12 •
CB/807IPR	IPR15	25	12 •
CB/808IPR	IPR20	25	12 •
CB/809IPR	IPR25	25	12 •
CB/810IPR	IPR27	25	12 •
CB/811IPR	IPR30	25	12 •
CB/812IPR	IPR40	25	12 •

## CB/850 Series

XZN (Spline) Bits  
DIN 3126-C 6.3, ISO 1173



Especially for use in automotive

CODE NO		mm	
CB/854	M4	25	12 •
CB/855	M5	25	12 •
CB/856	M6	25	12 •
CB/858	M8	25	12 •

## CB/1800 Series

Hexagon Bits  
TS ISO 2936, DIN 3126-C 6.3, ISO 1173



CODE NO	mm	mm	
CB/1815	1.5	25	12 •
CB/1820	2	25	12 •
CB/1825	2.5	25	12 •
CB/1830	3	25	12 •
CB/1835	3.5	25	12 •
CB/1840	4	25	12 •
CB/1850	5	25	12 •
CB/1860	6	25	12 •
CB/1880	8	25	12 •
CB/1810	10	25	12 •

## CB/840 Series

Square Bits  
DIN 3126-C 6.3, ISO 1173



For square socket (Robertson) screws

CODE NO		mm	
CB/841	No.1	25	12 •
CB/842	No.2	25	12 •
CB/843	No.3	25	12 •

## CB/1800 Series - SAE

Hexagon Bits - SAE  
DIN 3126-C 6.3, ISO 1173



CODE NO	"	mm	
CB/180332	3/32	25	12 •
CB/180108	1/8	25	12 •
CB/180964	9/64	25	12 •
CB/180532	5/32	25	12 •
CB/180316	3/16	25	12 •
CB/180732	7/32	25	12 •
CB/180104	1/4	25	12 •

## CB/SVB25

Schrader® Valve Core Tool Bit

**new**



For removal of cores from inside the valves

CODE NO	mm	mm	
CB/SVB25	4	25	12 •



# AEROSPACE BITS



## CB/870 Series

TRI-WING Bits (25 mm)  
DIN 3126-C 6.3, ISO 1173



For TRI-WING screws

CODE NO		mm	
CB/871	TW1	25	12 •
CB/872	TW2	25	12 •
CB/873	TW3	25	12 •
CB/874	TW4	25	12 •
CB/875	TW5	25	12 •

## CB/860 Series

TORQ-SET Insert Bits (25 mm)



Especially for use in aviation industry

CODE NO		mm	
CB/860	No.0	25	12 •
CB/861	No.1	25	12 •
CB/862	No.2	25	12 •
CB/863	No.3	25	12 •
CB/864	No.4	25	12 •
CB/865	No.5	25	12 •
CB/866	No.6	25	12 •
CB/867	No.8	25	12 •
CB/868	No.10	25	12 •
CB/869	1/4"	25	12 •

## CB/860510

TORQ-SET Power Bits (50 mm)



**new**



Especially for use in aviation industry

CODE NO		mm	
CB/860510	No.10	50	12 •

## CB/8603 Series

TORQ-SET Power Bits (32 mm)



**new**

DIN 3126-E 6.3, ISO 1173



Especially for use in aviation industry

CODE NO		mm	
CB/860300	No.0	32	12 •
CB/860301	No.1	32	12 •
CB/860302	No.2	32	12 •
CB/860303	No.3	32	12 •
CB/860304	No.4	32	12 •
CB/860305	No.5	32	12 •
CB/860306	No.6	32	12 •
CB/860308	No.8	32	12 •
CB/860310	No.10	32	12 •
CB/860314	1/4"	32	12 •

## CB/8613 Series

5/16" TORQ-SET Power Bits (32 mm)



**new**

DIN 3126-E 6.3, ISO 1173



Especially for use in aviation industry

CODE NO		mm	
CB/861314	1/4"	32	12 •
CB/861351	5/16"	32	12 •

# 05 Screwdrivers and Bits

## 1/4" Power Bits

### CB/490 Series

Phillips Bits  
DIN ISO 8764-1, TS 8748-2  
DIN 3126-E 6.3, ISO 1173



CODE NO	+	mm	Box
CB/491	PH1	50	12 •
CB/492	PH2	50	12 •
CB/493	PH3	50	12 •

### CB/492D

Phillips Bit Display Pack (PH2)- 240 Pieces



CODE NO	+	Box
CB/492D		1
<b>240x CB/492 (PH2)</b>		

### CB/490X Series

Phillips Bits (Display Packed)



The code represents a 3 piece package

CODE NO	+	mm	Box
CB/491X	PH1	50	12 packs
CB/492X	PH2	50	12 packs
CB/493X	PH3	50	12 packs

### CB/662TM

Double Ended Phillips Bits (Torsion)

DIN 5264-C, DIN ISO 8764



Torsion zone allows for higher torque values

CODE NO	+	mm	Box
CB/662TM	PH2 / PH2	65	12 •

### CB/490B Series

Phillips Bits (in 50 pc. Packs)



**ECO  
PACK**

CODE NO	+	mm	Box
CB/491B	PH1	50	50 •
CB/492B	PH2	50	50 •
CB/493B	PH3	50	50 •

### CB/492BD

Phillips Bit Display Pack (PH2) - 500 Pieces



CODE NO	+	Box
CB/492BD		1
<b>500x CB/492B (PH2)</b>		

### CB/XL Series - PH

Phillips Bits - Extra Long

DIN ISO 8764-1, TS 8748-2  
DIN 3126-E 6.3, ISO 1173



CODE NO	+	mm	Box
CB/701	PH1	70	12 •
CB/702	PH2	70	12 •
CB/703	PH3	70	12 •
CB/901	PH1	90	12 •
CB/902	PH2	90	12 •
CB/903	PH3	90	12 •
CB/1101	PH1	110	12 •
CB/1102	PH2	110	12 •
CB/1103	PH3	110	12 •
CB/1271	PH1	127	12 •
CB/1272	PH2	127	12 •
CB/1273	PH3	127	12 •
CB/1521	PH1	150	12 •
CB/1522	PH2	150	12 •
CB/1523	PH3	150	12 •

### CB/590 Series

Pozidriv Bits

DIN ISO 8764-1, TS 8748-2, DIN 3126-E 6.3, ISO 1173



CODE NO	+	mm	Box
CB/591	PZ1	50	12 •
CB/592	PZ2	50	12 •
CB/593	PZ3	50	12 •

### CB/592D

Pozidriv Bit Display Pack (PZ2) - 240 Pieces



CODE NO	+	Box
CB/592D		1
<b>240x CB/592 (PZ2)</b>		

### CB/590X Series

Pozidriv Bits (Display Packed)



The code represents a 3 piece package

CODE NO	+	mm	Box
CB/591X	PZ1	50	12 packs
CB/592X	PZ2	50	12 packs
CB/593X	PZ3	50	12 packs

# 1/4" Power Bits

## CB/590B Series

Pozidriv Bits (in 50 pc. Packs)



**ECO  
PACK**

CODE NO	+	mm	
CB/591B	PZ1	50	50 •
CB/592B	PZ2	50	50 •
CB/593B	PZ3	50	50 •

## CB/592BD

Pozidriv Bit Display Pack (PZ2) - 500 Pieces

**BUY MORE  
PAY LESS**



CODE NO	
CB/592BD	1
500x CB/592B (PZ2)	

## CB/XL Series - PZ

Pozidriv Bits - Extra Long

DIN ISO 8764-1, TS 8748-2, DIN 3126-E.6.3, ISO 1173



CODE NO	+	mm	
CB/711	PZ1	70	12 •
CB/712	PZ2	70	12 •
CB/713	PZ3	70	12 •
CB/911	PZ1	90	12 •
CB/912	PZ2	90	12 •
CB/913	PZ3	90	12 •

## CB/820 Series

TORX Bits

DIN 3126-E.6.3, ISO 1173



CODE NO		mm	
CB/820	T06	50	12 •
CB/821	T07	50	12 •
CB/822	T08	50	12 •
CB/823	T09	50	12 •
CB/824	T10	50	12 •
CB/825	T15	50	12 •
CB/826	T20	50	12 •
CB/827	T25	50	12 •
CB/828	T27	50	12 •
CB/829	T30	50	12 •
CB/830	T40	50	12 •

## CB/820X Series

TORX Bits (Display Packed)

**new**



The code represents a 3 piece package

CODE NO		mm	
CB/824X	T10	50	12 packs
CB/825X	T15	50	12 packs
CB/826X	T20	50	12 packs
CB/827X	T25	50	12 packs
CB/829X	T30	50	12 packs
CB/830X	T40	50	12 packs

## CB/XL Series - TORX

TORX Bits - Extra Long

DIN 3126-E.6.3, ISO 1173



CODE NO		mm	
CB/8094	T10	90	12 •
CB/8095	T15	90	12 •
CB/8096	T20	90	12 •
CB/8097	T25	90	12 •
CB/8099	T30	90	12 •
CB/8156	T20	150	12 •
CB/8157	T25	150	12 •
CB/8159	T30	150	12 •

## CB/820B Series

TORX Bits (in 50 pc. Packs)



**ECO  
PACK**

CODE NO		mm	
CB/824B	T10	50	50 •
CB/825B	T15	50	50 •
CB/826B	T20	50	50 •
CB/827B	T25	50	50 •
CB/829B	T30	50	50 •

## CB/820BD Series

TORX Bit Display Packs - 500 Pieces

**BUY MORE  
PAY LESS**



CODE NO	
CB/826BD	1
500x CB/826B (T20)	
CB/829BD	1
500x CB/829B (T30)	

## CB/600 Series

Slotted Bits

DIN 5264-C, ISO 2380, TS 8748-1

DIN 3126-E.6.3, ISO 1173



CODE NO	mm	mm	
CB/619	3.0	50	12 •
CB/620	4.0	50	12 •
CB/618	4.5	50	12 •
CB/621	5.5	50	12 •
CB/622	6.5	50	12 •

# 05 Screwdrivers and Bits

## 1/4" Power Bits and Nut Setters

### CB/1900 Series

Hexagon Bits

TS ISO 2936, DIN 3126-E 6.3, ISO 1173



CODE NO	mm	mm	
CB/1915	1.5	50	12 •
CB/1920	2	50	12 •
CB/1925	2.5	50	12 •
CB/1930	3	50	12 •
CB/1940	4	50	12 •
CB/1950	5	50	12 •
CB/1960	6	50	12 •
CB/1980	8	50	12 •

### BTD Series

Deep Nut Setters

DIN 3126-E 6.3, ISO 1173



Deep recess ideal for long threaded bolts

CODE NO	mm	mm	
BTD/08	8	90	6 •
BTD/10	10	90	6 •
BTD/13	13	110	6 •

### CB/8800 Series

Nut Setters (Magnetic)

DIN 5264-C, ISO 2380, DIN 3126-C 6.3, ISO 1173



CODE NO	mm	mm	
CB/8806	6	33	12 •
CB/8807	7	33	12 •

### BTA/42 Series

Nut Setters (Magnetic) - SAE

DIN 3126-E 6.3, ISO 1173



CODE NO	"	mm	
BTA/010442	1/4	42	6 •
BTA/051642	5/16	42	6 •
BTA/010245	1/2	45	6 •

### CB/1900 Series - SAE

Hexagon Bits - SAE

DIN 3126-E 6.3, ISO 1173

**new**



CODE NO	"	mm	
CB/190332	3/32	50	12 •
CB/190532	5/32	50	12 •
CB/190316	3/16	50	12 •

### BT/42 Series

Nut Setters (Magnetic) - 45 mm

DIN 3126-E 6.3, ISO 1173



CODE NO	mm	mm	
BT/0642	6	45	12 •
BT/0742	7	45	12 •
BT/0842	8	45	12 •
BT/1045	10	45	12 •

For display carded delivery = Item code + X  
Available for BT/0842, BT1045

### BT/65 Series

Nut Setters (Magnetic) - 65 mm

DIN 3126-E 6.3, ISO 1173



CODE NO	mm	mm	
BT/0665	6	65	12 •
BT/0765	7	65	10 •
BT/0865	8	65	10 •
BT/1065	10	65	8 •
BT/1165	11	65	4 •
BT/1265	12	65	4 •
BT/1365	13	65	4 •
BT/1465	14	65	4 •
BT/1765	17	65	3 •

For display carded delivery = Item code + X  
Available for BT/0865, BT1065

## M5 Power Bits

### CB/PH2M5

Phillips Bit (for Stationary Screw Systems)

DIN ISO 8764-1, TS 8748-2



M5 thread drive, ideal for use in stationary screw systems

CODE NO		mm	
CB/PH2M5	PH2	45	6 •

### CB/PZ2M5

Pozidriv Bit (for Stationary Screw Systems)

DIN ISO 8764-1, TS 8748-2



M5 thread drive, ideal for use in stationary screw systems

CODE NO		mm	
CB/PZ2M5	PZ2	45	6 •

### CB/T M5 Series

TORX Bits (for Stationary Screw Systems)



M5 thread drive, ideal for use in stationary screw systems

CODE NO		mm	
CB/T25M5	T25	45	6 •
CB/T30M5	T30	45	6 •

### BT/ST061

6 Piece Nut Setter Set - 65 mm

**new**



CODE NO	
BT/ST061	6



BT/65: 6, 7, 8, 10, 12, 13 mm

# 5/16" Impact Drivers and Bits

The ideal range for impact assisted loosening of tight or frozen screws



## F28-P12

12 Piece Impact Bit Driver Set



CODE NO	Image	Quantity
F28-P12		1
CB/516SL 10 mm		
CB/516PH PH2, PH3, PH4		
CB/516TX T30, T40, T45, T50		
CB/516HX 5, 6, 8 mm		
F28/BT 5/16" Impact Bit Driver		

## F28/BT

5/16" Impact Bit Driver



CODE NO	Length (mm)	Quantity
F28/BT	145	1

## CB/516SL Series

Slotted Bits (Impact Grade)



DIN 5264-C, ISO 2380, DIN 3126-C8, ISO 1173



CODE NO	Length (mm)	Width (mm)	Quantity
CB/516SL08	8	30	6•
CB/516SL10	10	30	6•
CB/516SL12	12	30	6•

## CB/516PH Series

Phillips Bits (Impact Grade)



DIN ISO 8764-1, DIN 3126-C8, ISO 1173



CODE NO	Type	Length (mm)	Quantity
CB/516PH2	PH2	30	6•
CB/516PH3	PH3	30	6•
CB/516PH4	PH4	30	6•

## CB/516TX Series

TORX Bits (Impact Grade)



DIN 3126-C8, ISO 1173



CODE NO	Type	Length (mm)	Quantity
CB/516TX20	T20	30	6•
CB/516TX25	T25	30	6•
CB/516TX30	T30	30	6•
CB/516TX40	T40	30	6•
CB/516TX45	T45	30	6•
CB/516TX50	T50	30	6•
CB/516TX55	T55	30	6•

## CB/516HX Series

Hexagon Bits (Impact Grade)



TS ISO 2936, DIN 3126-C8, ISO 1173



CODE NO	Length (mm)	Width (mm)	Quantity
CB/516HX05	5	30	6•
CB/516HX06	6	30	6•
CB/516HX07	7	30	6•
CB/516HX08	8	30	6•
CB/516HX10	10	30	6•
CB/516HX12	12	30	6•
CB/516HX14	14	30	6•

## CB/516XZ06

XZN (Splined) Bit (Impact Grade)



DIN 3126-C8, ISO 1173



CODE NO	Type	Length (mm)	Quantity
CB/516XZ06	M06	30	6•



# 05 Screwdrivers and Bits

## 10 mm Bits Range

For use with bit holder sockets BT/8008 and BT/8005. Chrome Vanadium Molybdenum steel, hardened and tempered. Precision machined for exact fit.

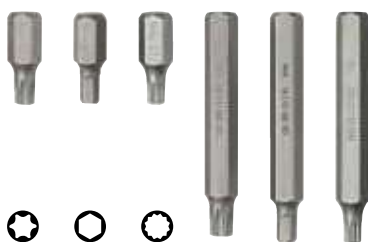

Chapter /3 Page 128



### CB/1000G Series TORX Bits - Short

10 mm



CODE NO		mm	
CB/1020G	T20	30	12 •
CB/1025G	T25	30	12 •
CB/1027G	T27	30	12 •
CB/1030G	T30	30	12 •
CB/1040G	T40	30	12 •
CB/1045G	T45	30	12 •
CB/1050G	T50	30	12 •
CB/1055G	T55	30	12 •
CB/1060G	T60	30	12 •

### CB/2000G Series Hexagon Bits - Short

10 mm



CODE NO	mm	mm	
CB/2004G	4	30	12 •
CB/2005G	5	30	12 •
CB/2006G	6	30	12 •
CB/2007G	7	30	12 •
CB/2008G	8	30	12 •
CB/2010G	10	30	12 •
CB/2012G	12	30	12 •

### CB/3000G Series XZN (Spline) Bits - Short

10 mm



CODE NO		mm	
CB/3005G	M05	30	12 •
CB/3006G	M06	30	12 •
CB/3008G	M08	30	12 •
CB/3010G	M10	30	12 •
CB/3012G	M12	30	12 •

### CB/1100G Series TORX Bits - Long

10 mm



CODE NO		mm	
CB/1120G	T20	75	10 •
CB/1125G	T25	75	10 •
CB/1127G	T27	75	10 •
CB/1130G	T30	75	10 •
CB/1140G	T40	75	10 •
CB/1145G	T45	75	10 •
CB/1150G	T50	75	10 •
CB/1155G	T55	75	10 •
CB/1160G	T60	75	6 •

### CB/2100G Series Hexagon Bits - Long

10 mm



CODE NO	mm	mm	
CB/2104G	4	75	10 •
CB/2105G	5	75	10 •
CB/2106G	6	75	10 •
CB/2107G	7	75	10 •
CB/2108G	8	75	10 •
CB/2110G	10	75	10 •
CB/2112G	12	75	6 •
CB/2210G	10	115	6 •
CB/2212G	12	115	6 •

### CB/3100G Series XZN (Spline) Bits - Long

10 mm



CODE NO		mm	
CB/3105G	M05	75	10 •
CB/3106G	M06	75	10 •
CB/3108G	M08	75	10 •
CB/3110G	M10	75	10 •
CB/3112G	M12	75	6 •

## Socket Adaptors

### BT/7000 Series - M

Socket Adaptors (for Manual Use)

DIN 3126-C6.3, ISO 1173



Ideal for manual use, spring loaded ball bearing

CODE NO	"	"	mm	
BT/7010	1/4	1/4	25	12 •
BT/7017M *	1/4	1/4	75	12 •
BT/7027 *	3/8	1/4	75	6 •
BT/7028 *	3/8	1/4	100	6 •

\* Limited with stocks

### BT/7000 Series - P

Socket Adaptors (for Power Use)

DIN 3126-E6.3, ISO 1173



Ideal for power use, spring loaded ball bearing

CODE NO	"	"	mm	
BT/7015	1/4	1/4	50	12 •
BT/7018	1/4	1/4	100	12 •
BT/7020	3/8	1/4	50	6 •
BT/7030	1/2	1/4	50	6 •

### BT/7000S3

3 Piece Socket Adaptor Set

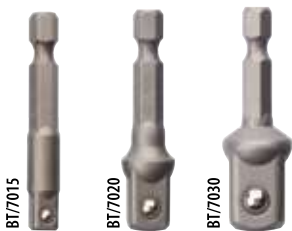

CODE NO	
BT/7000S3	10

BT/7015 1/4"-1/4"

BT/7020 3/8"-1/4"

BT/7030 1/2"-1/4"

## Bit Holders

### BT/01QH

Magnetic Bit Holder (Quick Release)

DIN 3126-E6.3, ISO 1173



Suitable for 1/4" hex C 6.3 and E 6.3 bits, quick release mechanism, strong permanent magnet

CODE NO	"	mm	
BT/01QH	1/4	60	6

### BT/01SH

Magnetic Bit Holder (Screw Grab Magnet)

DIN 3126-E6.3, ISO 1173



Suitable for 1/4" hex C 6.3 bits, unique ring magnet securely holds the screw, strong permanent magnet

CODE NO	"	mm	
BT/01SH	1/4	60	6

### BT/01DUO

DUO Bit Holder (with Socket Adaptor)

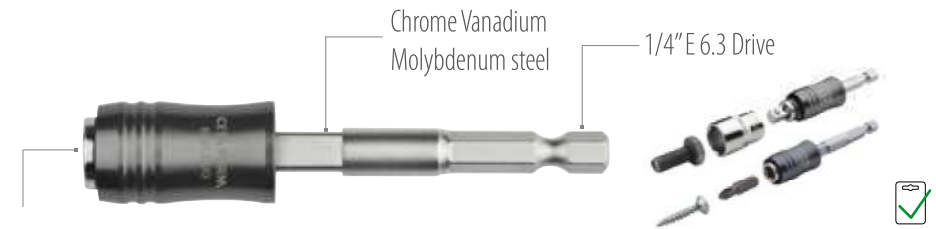

6.3 1/4" 1/4" Drive socket and bits holder

CODE NO	"	mm	
BT/01DUO	1/4	75-85	6

### BT/01XF

1/4" Long Reach Bit Holder (Flexible Shaft)



Particularly for use in restricted areas thanks to long and flexible shaft

Max 57 Nm - 2000 rpm

CODE NO	"	mm	
BT/01XF	1/4	300	10

### BT/00 Series

Magnetic Bit Holders

DIN 3126-E6.3, ISO 1173



Suitable for 1/4" hex C 6.3 bits, stainless steel sleeve with strong permanent magnet

CODE NO	"	mm	
BT/02	1/4	60	10 •
BT/03	1/4	75	10 •
BT/05	1/4	150	10 •

For display carded delivery = Item code + X 10

### BT/08

Magnetic Bit Holder - SDS-Plus

DIN 3126-E6.3, ISO 1173



SDS-Plus drive, suitable for 1/4" hex C 6.3 bits, stainless steel sleeve with strong permanent magnet

CODE NO	"	mm	
BT/08	1/4	80	10 •

For display carded delivery = Item code + X 10

# 05 Screwdrivers and Bits

## Bit Drivers

### 12-in1 Stubby Ratchet Bit Driver

Handy, compact and robust

- Compact sizes for confined spaces
- Forged ratchet components for robustness
- 12 sizes in 6 double ended bits
- Retractable bit cartridge



- ⊕ x2 PH1/4.0 mm x 30 mm  
⊖ PH2/5.0 mm x 30 mm
- ⊕ x2 PZ1/4.0 mm x 30 mm  
⊖ PZ2/5.0 mm x 30 mm
- ⊖ x1 6.0/6.0 mm x 30 mm
- ⊕ x1 T20/T30 x 30 mm

#### F26/RDS

12-in-1 Stubby Ratchet Bit Driver



CODE NO	1/4"	mm	12 •
F26/RDS	1/4	105	12 •

#### F26/BDS

12-in-1 Stubby Bit Driver



CODE NO	1/4"	mm	12
F26/BDS	1/4	90	12

#### CB/660 Series

Double Ended Insert Bits

DIN 3126, ISO 1173



CODE NO	SIZE	TIP	mm	12 •
CB/660P1S4	PH1 / 4.0	⊕ ⊖	30	12 •
CB/660P2S5	PH2 / 5.0	⊕ ⊖	30	12 •
CB/660Z1H4	PZ1 / 4.0	⊕ ⊖	30	12 •
CB/660Z2H5	PZ2 / 5.0	⊕ ⊖	30	12 •
CB/660S6H6	6.0 / 6.0	⊖ ⊕	30	12 •
CB/660T2T3	T20 / T30	⊕ ⊖	30	12 •

#### F26/BT Series

C-PLUS Bit Drivers



Suitable for 1/4" hex C 6.3 bits, stainless steel sleeve with strong permanent magnet

CODE NO	1/4"	mm	12
F26/BT	1/4	100	12
F26/BTL	1/4	300	12

#### F26/LBT

C-PLUS Bit Driver (Compact-Quick Release)



Suitable for 1/4" hex C 6.3 and E 6.3 bits, quick release mechanism, strong permanent magnet

CODE NO	1/4"	mm	12
F26/LBT	1/4	146	12

#### F26/SGBT

C-PLUS Bit Driver (Screw Grab Magnet)



Suitable for 1/4" hex C 6.3 bits, unique ring magnet securely holds the screw, strong permanent magnet

CODE NO	1/4"	mm	12
F26/SGBT	1/4	100	12

#### F26/SBT

C-PLUS Bit Driver (Compact)



Suitable for 1/4" hex C 6.3 bits, stainless steel holder with strong permanent magnet

CODE NO	1/4"	mm	12
F26/SBT	1/4	110	12

#### F26/FBT

C-Plus Bit Driver (Flexible Shaft)



Suitable for 1/4" hex C 6.3 bits, flexible shaft for restricted areas, strong permanent magnet

CODE NO	1/4"	mm	12
F26/FBT	1/4	150	12



## Bit Drivers and Bit Ratchets

### F26/TBT T-Handle Bit Driver



Suitable for 1/4" hex C 6.3 bits, stainless steel sleeve with strong permanent magnet

CODE NO	1/4"	mm	6
F26/TBT	1/4	160	6

### 3100/BT1 Bit Driver with Magazine



Suitable for 1/4" hex C 6.3 bits, stainless steel sleeve with strong permanent magnet

CODE NO	1/4"	mm	12
3100/BT1	1/4	100	12

### 3100/BT6A 7 Piece Bit Driver Set



CODE NO	12
3100/BT6A	12

3100/BT1 1/4"x60 mm

CB/250 PH1, PH2

CB/610 4.0, 5.5, 6.5 mm

CB/350 PZ1

## Reversible Bit Ratchets

Supplied with 1/4" drive socket adaptor

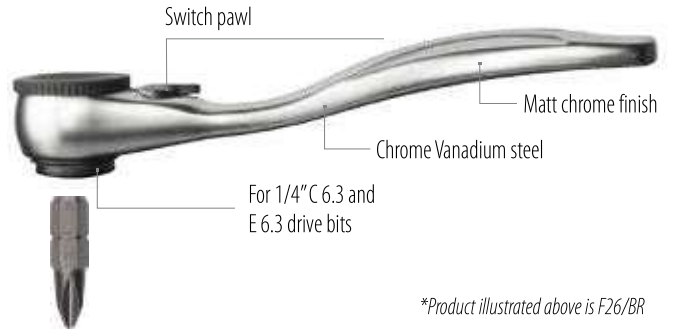

Switch pawl

Matt chrome finish

Chrome Vanadium steel

For 1/4" C 6.3 and E 6.3 drive bits

\*Product illustrated above is F26/BR

### F26/BR Reversible Bit Ratchet #1

- 72-tooth fine mechanism
- Forged body (curved)
- Switch lever
- Supplied with 1/4" socket adaptor



CODE NO	1/4"	mm	6
F26/BR	1/4	95	6

### F26/BR2 Reversible Bit Ratchet #2

**new**

- 60-tooth fine mechanism
- Forged body (flat)
- Switch lever
- Low profile for maximum access



CODE NO	1/4"	mm	6
F26/BR2	1/4	90	6

### F26/BR3 Reversible Bit Ratchet #3

**new**

- 15-tooth basic mechanism
- Punched steel body
- Switch lever
- Super low profile for maximum access



CODE NO	1/4"	mm	6
F26/BR3	1/4	100	6

# 05 Screwdrivers and Bits

## Gear Drivers

DIN 3126-E 6.3, ISO 1173

1/4  
"

### F26/AG Angled Gear Driver (Rotating Arm 90°)



CODE NO	$\frac{1}{4}$ "	mm	
F26/AG	1/4	140	6

Suitable for 1/4" hex C 6.3 and E 6.3 bits, for use with power tools especially in restricted areas, 90° pivoting arm, 360° rotating head, compact design

Max 57 Nm - 2000 rpm

### F26/AG-2 Angled Gear Driver (Fixed Arm)



CODE NO	$\frac{1}{4}$ "	mm	
F26/AG-2	1/4	140	12

Suitable for 1/4" hex C 6.3 and E 6.3 bits, for use with power tools especially in restricted areas, right/left hand exchangeable grip, compact design

Max 32 Nm - 2000 rpm

### F26/AG-2F Long Reach Gear Driver (Flexible Shaft)



CODE NO	$\frac{1}{4}$ "	mm	
F26/AG-2F	1/4	305	5

All structural specs same as F26/AG-2 but with a flexible shaft for added access capability to restricted areas

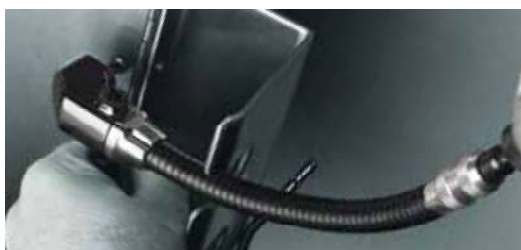

# Bit Sets

## CB/ST31 31 Piece Bit Set

**new**  
design



CODE NO



CB/ST31

6

- CB/610 4.0, 5.5, 6.5 mm
- CB/250 2xPH1, 3xPH2, PH3
- CB/350 2xPZ1, 3xPZ2, PZ3
- BT/02  $\odot$

- CB/800 T10, T15, T20, T25, T27, T30, T40
- CB/800T T20, T30
- CB/1800 2, 2.5, 3, 4, 5, 6 mm

## CB/ST25 25 Piece Mini Socket and Bit Set

**new**



**6.3**  
**1/4"**

CODE NO



CB/ST25

6

- F26/BR2
- BT/02  $\odot$
- BT/7010  $\odot$   $\frac{1}{4}$ "
- C02-H 6 PC  $\odot$   $\frac{1}{4}$ "
- 5.5, 6, 7, 8, 10, 13 mm

- CB/610 4.0, 6.5 mm
- CB/250 PH1, PH2
- CB/350 PZ1, PZ2
- CB/800 T10, T15, T20, T25, T30, T40
- CB/1800 3, 4, 5, 6 mm



## CB/ST111 11 Piece Bit Set - Slotted/PH/PZ

**new**  
content



CODE NO



CB/ST111

6

- CB/610 4.0, 6.5 mm
- CB/250 PH1, 2xPH2, PH3
- BT/02  $\odot$
- CB/350 PZ1, 2xPZ2, PZ3

## CB/ST113 11 Piece Bit Set - TORX

**new**  
content



CODE NO



CB/ST113

6

- CB/800 T6, T8, T9, T10, T15, T20, T25, T27, T30, T40

- BT/02  $\odot$

## CB/ST114 11 Piece Bit Set - Hexagon

**new**



CODE NO



CB/ST114

6

- CB/1800 2, 2.5, 2x3, 2x4, 2x5, 2x6 mm

- BT/02  $\odot$

## CB/ST112 11 Piece Bit Set - PH/PZ



CODE NO



CB/ST112

6

- CB/250 PH1, 3xPH2, PH3
- CB/350 PZ1, 3xPZ2, PZ3

- BT/02  $\odot$

## CB/ST113T 11 Piece Bit Set - TORX Tamper Proof

**new**



CODE NO



CB/ST113T

6

- CB/800T T10, T15, 2xT20, 2xT25, T27, 2xT30, T40

- BT/02  $\odot$

# 05 Screwdrivers and Bits

## Bit Sets

### CB/ST32

32 Piece Screwdriver Bit Set



CODE NO	
CB/ST32	6

- |                          |  |
|--------------------------|--|
| CB/610 4.0, 5.5, 6.5 mm  | CB/800 T10, T15, T20, T25, T27, T30, T40 |
| CB/250 2xPH1, 3xPH2, PH3 | CB/800T T20, T30                         |
| CB/350 2xPZ1, 3xPZ2, PZ3 | CB/1800 2, 2.5, 3, 4, 5, 6 mm            |
| BT/02                    | F26/SBT 1/4"                             |

### CB/ST56

56 Piece Screwdriver Bit Set



CODE NO	
CB/ST56	1

- |  |                                |
|--|--------------------------------|
| CB/610 4.0, 5.5, 6.5 mm                                  | CB/1800 2, 2.5, 3, 4, 5, 6 mm  |
| CB/250 PH0, PH1, PH2, PH3                                | CB/840 No.1, No.2, No.3        |
| CB/350 PZ0, PZ1 PZ2, PZ3                                 | CB/850 M5, M6, M8              |
| CB/800 T6, T7, T8, T9, T10, T15, T20, T25, T27, T30, T40 | CB/860 No.6, No.8, No.10       |
| CB/800T T10, T15, T20, T25, T27, T30, T40                | CB/870 TW1, TW2, TW3, TW4, TW5 |
| CB/800IPR IPR20, IPR25, IPR30                            | BT/7010                        |
| F26/BT C-PLUS Bit Driver                                 | BT/8001 1/4" - 1/4"            |
| BT/02  |                                |

### CB/ST61

61 Piece Bit Set



CODE NO	
CB/ST61	6

- |                               |  |
|-------------------------------|--|
| CB/610 4.0, 5.5, 6.5 mm       | CB/800 T6, T7, T8, T9, T10, T15, 2xT20, T25, T27, 2xT30, T40 |
| CB/250 PH0, PH1, 10xPH2, PH3  | CB/800T T10, T15, T20, T25, T27, T30, T40                    |
| CB/350 PZ0, PZ1, 10xPZ2, PZ3  | CB/800IPR IPR20  |
| CB/840 No.1, No.2, No.3       | BT/8001 1/4" - 1/4"  |
| CB/1800 2, 2.5, 3, 4, 5, 6 mm | BT/02  |

# 6

**CETA FORM**®

Pliers and Cutters

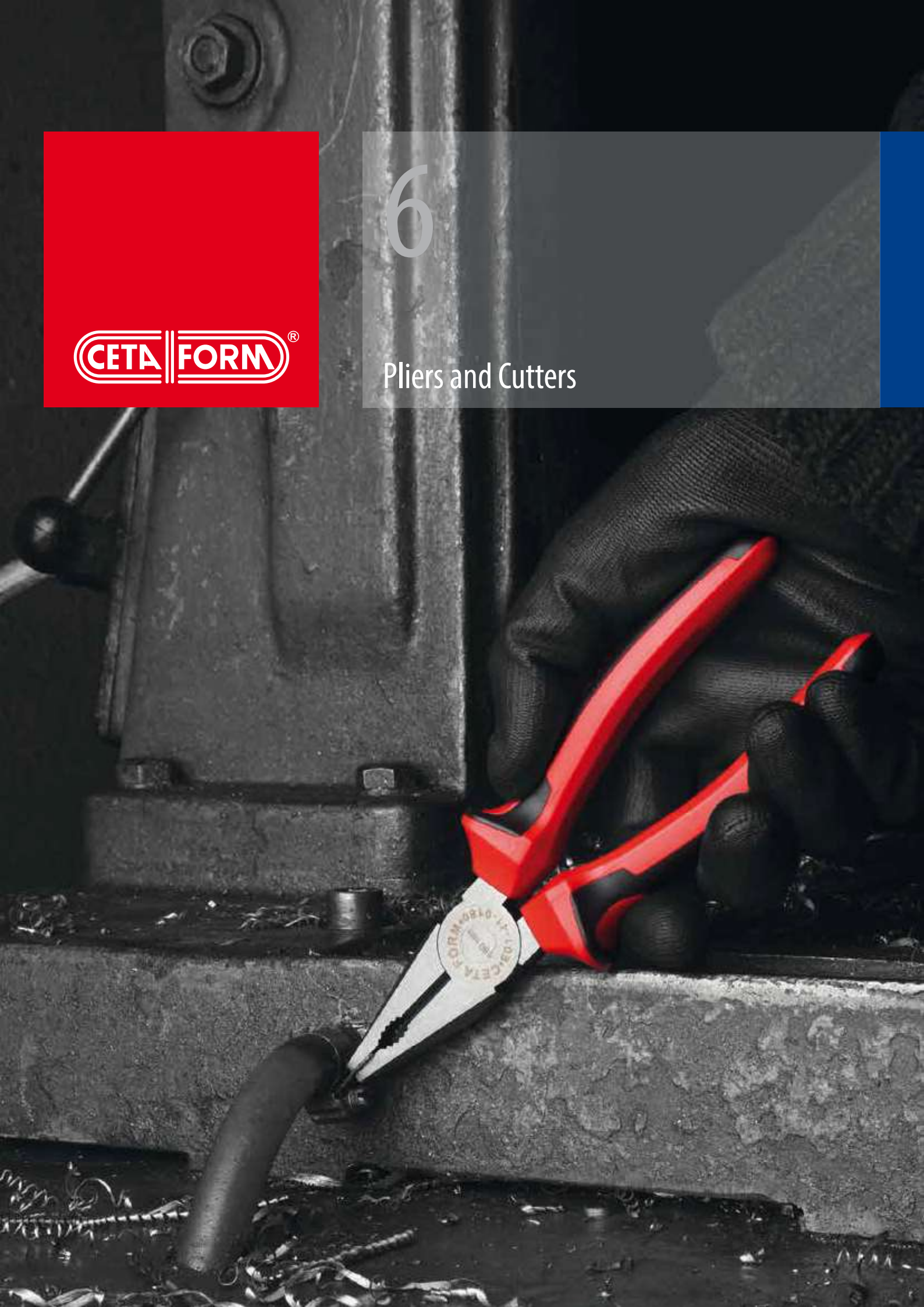

# 06 Pliers and Cutters

## High Leverage Pliers Programme

Easier cutting thanks to optimised leverage

### SMART

Dramatically less cutting effort required compared to traditional pliers thanks to the placement of the joint area close the cutting edge.

### DURABLE

Premium quality German steel from Solingen coupled with the machining and heat treatment know-how of Ceta Form ensures long years of tool life.



### ERGONOMIC

The well-known Ceta Form ergonomics is self-evident also in this new series. Hours of fatigue-free use is possible.

**30%**

### E01H Series

High Leverage Combination Pliers

DIN / TS ISO 5746



Dramatically less effort required for cutting compared to conventional pliers, suitable for soft and hard wire

CODE NO	mm "	Ø mm	
E01H-41-0180	180 - 7"	2.0	6
E01H-41-0200	200 - 8"	2.5	6

### E06H-41-0160

High Leverage Diagonal Cutter

DIN / TS ISO 5749



Dramatically less effort required for cutting compared to conventional cutters, suitable for soft and hard wire

CODE NO	mm "	Ø mm	
E06H-41-0160	160 - 6"	2.0	6

### E99H-41-02A

2 Piece High Leverage Pliers Set

DIN / TS ISO 5746



E01H-41-0180  
(180 mm)  
E06H-41-0160  
(160 mm)



CODE NO



E99H-41-02A

1

### E08 Series

Power Diagonal Cutters

DIN / TS ISO 5749



Dramatically less effort required for cutting compared to conventional cutters, heavy duty design, suitable for piano wire

CODE NO	mm "	Ø mm	
E08-41-0180	180 - 7"	2.0	6
E08-41-0200	200 - 8"	2.2	6

Approximately 30% less cutting power needed



Forged in Germany

## Combination Pliers

### E01-11 Series

Combination Pliers  
(Chrome Finish / DuoTech Handles)

DIN / TS ISO 5746



Suitable for cutting soft and hard wire

CODE NO	mm "	Ø mm	
E01-11-0160	160 - 6"	1.8	6
E01-11-0180	180 - 7"	2.0	6
E01-11-0200	200 - 8"	2.5	6

### E01-41 Series

Combination Pliers  
(Polished Finish / DuoTech Handles)

DIN / TS ISO 5746



Suitable for cutting soft and hard wire

CODE NO	mm "	Ø mm	
E01-41-0160	160 - 6"	1.8	6
E01-41-0180	180 - 7"	2.0	6
E01-41-0200	200 - 8"	2.5	6

### E01-44 Series

Combination Pliers  
(Polished Finish / PVC Sleeves)

DIN / TS ISO 5746



Suitable for cutting soft and hard wire

CODE NO	mm "	Ø mm	
E01-44-0160	160 - 6"	1.8	6
E01-44-0180	180 - 7"	2.0	6
E01-44-0200	200 - 8"	2.5	6

## Diagonal Cutters

### E06-11 Series

Diagonal Cutters  
(Chrome Finish / DuoTech Handles)

DIN / TS ISO 5749



Suitable for cutting soft and hard wire

CODE NO	mm "	Ø mm	
E06-11-0140	140 - 5-1/2"	1.8	6
E06-11-0160	160 - 6"	2.0	6
E06-11-0180	180 - 7"	2.5	6

### E06-41 Series

Diagonal Cutters  
(Polished Finish / DuoTech Handles)

DIN / TS ISO 5749



Suitable for cutting soft and hard wire

CODE NO	mm "	Ø mm	
E06-41-0140	140 - 5-1/2"	1.8	6
E06-41-0160	160 - 6"	2.0	6
E06-41-0180	180 - 7"	2.5	6

### E06-44 Series

Diagonal Cutters  
(Polished Finish / PVC Sleeves)

DIN / TS ISO 5749



Suitable for cutting soft and hard wire

CODE NO	mm "	Ø mm	
E06-44-0125	125 - 5"	1.5	6
E06-44-0140	140 - 5-1/2"	1.8	6
E06-44-0160	160 - 6"	2.0	6
E06-44-0180	180 - 7"	2.5	6

## Display Packs and Plastic Cutters

### SE11-24

24 Piece Pliers Display Pack  
(Chrome Finish / DuoTech Handles)

12x E01-11-0180  
(180 mm)

12x E06-11-0160  
(160 mm)

BUY MORE  
PAY LESS



CODE NO	
SE11-24	1

### SE41-24

24 Piece Pliers Display Pack  
(Polished Finish / DuoTech Handles)

12x E01-41-0180  
(180 mm)

12x E06-41-0160  
(160 mm)

BUY MORE  
PAY LESS



CODE NO	
SE41-24	1

### E09 Series

Diagonal Cutters (for Plastic)



Suitable for flush cutting of plastics  
Not suitable for cutting steel wires

CODE NO	mm "	
E09-44-0140	140 - 5-1/2"	6
E09-44-0160	160 - 6"	6

# 06 Pliers and Cutters

## Pliers Sets / Slip Joint Pliers / Duckbill Pliers

### E99-41-02A 2 Piece Pliers Set

E01-41-0180  
(180 mm)  
E06-41-0160  
(160 mm)

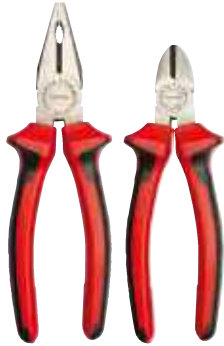

CODE NO

E99-41-02A



1

### E99-41-03A 3 Piece Pliers Set

E01-41-0180  
(180 mm)  
E06-41-0160  
(160 mm)  
E15-41-0160  
(160 mm)



CODE NO

E99-41-03A



1

### E99-41-03B 3 Piece Pliers Set (incl. E30 Water Pump Pliers)

E01-41-0180  
(180 mm)  
E06-41-0160  
(160 mm)  
E30-54-0250  
(250 mm)



CODE NO

E99-41-03B



1

### E99-41-W09 Series 9 Piece Pliers and Screwdriver Sets (in Vinyl Wallet)



CODE NO

E99-41-W09PH



1



E01-41-0180



E06-41-0160



E15-41-0160

F10 2.5x75, 4.0x100, 5.5x125 mm

F14 PH1x80, PH2x100 mm

6105CP Voltage Tester (Short)

E99-41-W09PZ

1

**Content:** Same as E99-41-W09PH but with Pozidriv screwdriver instead of Phillips.

### E19D-200 Duckbill Pliers



Duckbill shaped jaws 6 mm wide at the tip and tapering to 4 mm thickness

CODE NO

E19D-200

mm  
"

200 - 8"



6

### E05-44-0160 Slip Joint Pliers

DIN / ISO 9343



2-position adjustment

CODE NO

E05-44-0160

mm  
"

160 - 6"



6

## Long Nose Pliers

### E15-11 Series Long Nose Pliers (Chrome Finish / DuoTech Handles) DIN / TS ISO 5745



Suitable for cutting soft and hard wire

CODE NO	mm "	Ø mm	Icon of a box
E15-11-0160	160 - 6"	1.6	6
E15-11-0200	200 - 8"	1.6	6

### E15-41 Series Long Nose Pliers (Polished Finish / DuoTech Handles) DIN / TS ISO 5745



Suitable for cutting soft and hard wire

CODE NO	mm "	Ø mm	Icon of a box
E15-41-0160	160 - 6"	1.6	6
E15-41-0200	200 - 8"	1.6	6

### E15-44 Series Long Nose Pliers (Polished Finish / PVC Sleeves) DIN / TS ISO 5745



Suitable for cutting soft and hard wire

CODE NO	mm "	Ø mm	Icon of a box
E15-44-0160	160 - 6"	1.6	6
E15-44-0200	200 - 8"	1.6	6

# Long Nose Pliers

## E16-11 Series

Bent Long Nose Pliers  
(Chrome Finish / DuoTech Handles)

DIN / TS ISO 5745



Suitable for cutting soft and hard wire, 45° curved tip

CODE NO	mm "	Ø mm	
E16-11-0160	160 - 6"	1.6	6
E16-11-0200	200 - 8"	1.6	6

## E16-41 Series

Bent Long Nose Pliers  
(Polished Finish / DuoTech Handles)

DIN / TS ISO 5745



Suitable for cutting soft and hard wire, 45° curved tip

CODE NO	mm "	Ø mm	
E16-41-0160	160 - 6"	1.6	6
E16-41-0200	200 - 8"	1.6	6

## E16-44 Series

Bent Long Nose Pliers  
(Polished Finish / PVC Sleeves)

DIN / TS ISO 5745



Suitable for cutting soft and hard wire, 45° curved tip

CODE NO	mm "	Ø mm	
E16-44-0160	160 - 6"	1.6	6
E16-44-0200	200 - 8"	1.6	6

## E17-11-0160

Flat Nose Pliers (Chrome Finish / DuoTech Handles)

DIN / TS ISO 5745



Serrated gripping jaws

CODE NO	mm "	
E17-11-0160	160 - 6"	6

## E17-41-0160

Flat Nose Pliers (Polished Finish / DuoTech Handles)

DIN / TS ISO 5745



Serrated gripping jaws

CODE NO	mm "	
E17-41-0160	160 - 6"	6

## E15XL-340

Extra Long Nose Pliers (Double Fulcrum)



Double fulcrum construction and extra long dimensions allow for access to restricted areas

CODE NO	mm	
E15XL-340	340	6

## E18-11-0160

Round Nose Pliers (Polished Finish / DuoTech Handles)

DIN / TS ISO 5745



For bending wire loops

CODE NO	mm "	
E18-11-0160	160 - 6"	6

## E18-41-0160

Round Nose Pliers (Polished Finish / DuoTech Handles)

DIN / TS ISO 5745



For bending wire loops

CODE NO	mm "	
E18-41-0160	160 - 6"	6

## E16XL-340

Extra Long Bent Nose Pliers (Double Fulcrum)



Double fulcrum construction and extra long dimensions allow for access to restricted areas

CODE NO	mm	
E16XL-340	340	6

# 06 Pliers and Cutters

## Wire Strippers

**E25-11-0160**

Wire Stripping Pliers  
(Chrome Finish / DuoTech Handles)



For stripping of single / multi-strand conductors' plastic insulations

CODE NO	mm	mm <sup>2</sup>	mm
E25-11-0160	160 - 6"	10	6

**E25-41-0160**

Wire Stripping Pliers  
(Polished Finish / DuoTech Handles)



For stripping of single / multi-strand conductors' plastic insulations

CODE NO	mm	mm <sup>2</sup>	mm
E25-41-0160	160 - 6"	10	6

**E25-BS Series**

Wire Strippers (with Adapted Blades)



Leaves wire undamaged thanks to precision ground blade shapes, replaceable blades

CODE NO	Ø	mm	mm
E25-BSM20	0.5, 1.2, 1.6, 2.0 mm	165	5
E25-BSA22	AWG 8, 10, 12, 14, 18, 22	165	5

**E25-AT1**

Automatic Wire Stripper



For automatic stripping and cutting of conductors, also suitable for crimping terminals, self-adjusting mechanism

CODE NO	mm	mm <sup>2</sup>	mm
E25-AT1	205	6	10

**E25-AS06**

Automatic Wire Stripper



YouTube Clip



Adjustable length stop of 5 to 12 mm (removable if required), easily accessible built-in side cutter for max. 2 mm Ø

CODE NO	mm	mm <sup>2</sup>	mm
E25-AS06	170	0.2 - 6	6

**E25-C0S**

Coax-Stripper



Also strips flexible cables such as 3 x 0.75 mm<sup>2</sup>, 10 mm<sup>2</sup> and 16 mm<sup>2</sup>, needs no adjustment of the cutting depth

CODE NO	mm	mm <sup>2</sup>	mm
E25-C0S	110	4.8 - 7.5	12

**E25-MIC**

Micro Wire Stripper



Precise stripping, stepwise adjustment to the conductor diameters, with wire cutter

CODE NO	mm	mm <sup>2</sup>	mm
E25-MIC	100	0.25-0.8	6

**E25-CK28**

Cable Stripper



No damage of the inner conductors due to infinitely variable adjustment of the cutting depth

CODE NO	mm	mm <sup>2</sup>	mm
E25-CK28	140	8 - 28	12



for E25-CK28 & E25-CK28H

E25-CK28R	Spare Blade		6
-----------	-------------	--	---

**E25-CK28H**

Cable Stripper (Hook Knife)



No damage of the inner conductors due to infinitely variable adjustment of the cutting depth, hook knife

CODE NO	mm	mm <sup>2</sup>	mm
E25-CK28H	185	4 - 28	12

**E25-MULTI1**

Multi-Purpose Wire Stripper, Cutter and Crimping Tool



Strips AWG sizes 10, 12, 14, 16, 18, 20, 22  
Screw cutter for M2.6, M3, M3.5, M4, M4.5, M5  
Crimps 7-8 mm ignition,  
AWG 16-10 insulated, AWG 22-18 non-insulated terminals

CODE NO	mm	mm <sup>2</sup>	mm
E25-MULTI1	210 - 8 1/4"		10

# 06 Pliers and Cutters



## Water Pump Pliers

### E30 Water Pump Pliers

Forged in Germany



**E30-51-0250**  
Water Pump Pliers  
(Box Joint / DuoTech Handles)  
DIN ISO 8976



9-position adjustment

CODE NO	mm "	max. mm	6
E30-51-0250	250 - 10"	50	6

**E30-54 Series**  
Water Pump Pliers (Box Joint / PVC Sleeves)  
DIN ISO 8976



9-position adjustment

CODE NO	mm "	max. mm	6
E30-54-0250	250 - 10"	50	6
E30-54-0300	300 - 12"	70	6

### E30W Pliers Wrench (Parallel Jaws)

This smartly designed tool replaces the need for sets or metric and imperial wrenches. Parallel jaws allow for infinitely variable gripping of all widths. Fast adjustment directly on the workpiece is possible by pushing a button.



**E30W-54-0250**  
Pliers Wrench (Parallel Jaws)  
DIN ISO 8976



Parallel jaws allow infinitely variable gripping of all widths, fast adjustment directly on the work piece by pushing a button

CODE NO	mm "	mm	6
E30W-54-0250	250 - 10"	42	6

**E29-54-0250**  
Water Pump Pliers (Self-Adjusting)  
DIN ISO 8976

**new**



Automatic adjustment to the workpiece

CODE NO	mm "	max. mm	6
E29-54-0250	250 - 10"	35	6

**E34-250**  
Canon Plug Pliers (Exchangeable Plastic Jaws) **new**



For use on connectors, siphons and tube fittings, plastic jaws for sensitive surfaces

CODE NO	mm "	max. mm	6
E34-250	230 - 9"	65	6

**E34-250R**  
Spare Plastic Jaw Set (for E34-250) **new**



CODE NO	6
E34-250R	6

# 06 Pliers and Cutters



## Pincers and Nippers

### E36-54 Series

Concreters' Nippers (PVC Sleeves)

DIN ISO 9242, TS 60-12



For binding and cutting building wires

CODE NO	mm "	
E36-54-0225	225 - 9"	6
E36-54-0250	250 - 10"	6
E36-54-0280	280 - 11"	6
For display carded delivery = Item code + X		6

### E36-56 Series

Concreters' Nippers (No Sleeves)

DIN ISO 9242, TS 60-12



For binding and cutting building wires

CODE NO	mm "	
E36-56-0225	225 - 9"	6
E36-56-0250	250 - 10"	6
E36-56-0280	280 - 11"	6
For display carded delivery = Item code + X		6

### E35 Series

Carpenters' Pincers

DIN ISO 9243, TS 60-3



For removal of nails as well as cutting building wires

CODE NO	mm "	
E35-54-0160	160 - 6"	6
E35-54-0180	180 - 7"	6
E35-54-0200	200 - 8"	6
For display carded delivery = Item code + X		6

### E36-54-0280D

E36-54-0280 Concreters' Nippers Display Pack



CODE NO	
E36-54-0280D	1
8 x E36-54-0280	

### E36-56-0280D

E36-56-0280 Concreters' Nippers Display Pack



CODE NO	
E36-56-0280D	1
8 x E36-56-0280	

### E37 Series

End Cutting Nippers

DIN ISO 5748



For cutting soft and hard wire as well as binding/cutting building wires

CODE NO	mm "	
E37-54-0160	160 - 6"	6
E37-54-0180	180 - 7"	6
For display carded delivery = Item code + X		6

### E38-54-0200

Compact Bolt Cutter (for Nails, Rivets, Bolts etc)



For cutting nails, rivets, bolts etc., high-leverage design: minimum cutting effort

CODE NO	mm "	● Ø mm	
E38-54-0200	200 - 8"	3.6	6

Identical head dimensions on 250 mm and 280 mm versions of concreters' nippers. Selection according to different user habits in different countries.

# Grip Pliers

## X Grip

### Grip Pliers Series

The new grip pliers programme from Ceta Form. Superb mechanical properties now coupled with epoxy coating. Perfect anti-rust properties.

#### E50-2 Series

Grip Pliers (Curved Jaws)



For gripping and clamping round materials

CODE NO	mm	Ø max. mm	
E50-140-2	140	0-32	1
E50-190-2	190	0-42	1
E50-240-2	240	0-62	1
E50-300-2	300	0-75	1

#### E51-2 Series

Grip Pliers (Straight Jaws)



For gripping and clamping flat materials

CODE NO	mm	max. mm	
E51-190-2	190	0-42	1
E51-240-2	240	0-63	1

#### E52-240-2

Grip Pliers ( Prism Jaws)



For gripping and clamping round and flat materials

CODE NO	mm	Ø max. mm	
E52-240-2	240	0-62	1

#### E52S-240-2

Grip Pliers (Multi-Purpose Jaws)



For gripping and clamping round and flat materials

CODE NO	mm	Ø max. mm	
E52S-240-2	240	0-67	1

#### E50L-2 Series

Long Nose Grip Pliers



For gripping and clamping in tight spaces

CODE NO	mm	CAPACITY Max mm	
E50L-170-2	170	0-50	1
E50L-230-2	230	0-68	1

#### E53-280-2

Welder's Grip Pliers (Fork Jaws)



For gripping and clamping pipes, sheet steel, profiles etc., ideal for welders

CODE NO	mm	max. mm	
E53-280-2	290	0-90	1

#### E54-200-2

Clamp Grip Pliers (Sheet Metal)



For gripping and clamping flat materials, 80 mm jaws

CODE NO	mm	CAPACITY Max mm	
E54-200-2	200	0-55	1



# 06 Pliers and Cutters

## Grip Pliers

### E55-2 Series

Clamp Grip Pliers (C Jaw)



For gripping and clamping of angle sections and deep channels, ideal for welders

CODE NO	mm	max. mm	
E55-280-2	288	0-110	1
E55-470-2	470	0-260	1

### E55P-2 Series

Clamp Grip Pliers (C Jaw-Swivel Padded)



For gripping and clamping of angle sections and deep channels, ideal for welders, swivel pads for parallel clamping

CODE NO	mm	max. mm	
E55P-180-2	178	0-50	1
E55P-300-2	300	0-100	1

## E50MIC Micro Grip Pliers



World's smallest grip pliers. Indispensable in restricted areas thanks to micro dimensions and perpendicular gripping.

CODE NO	mm	CAPACITY Max mm	
E50MIC	91	0-12.7	1

### E56-L1

Axial Grip Pliers - L Jaw



Suitable for clamping of overlapping sheet steels, axial moving jaws allow for perpendicular grip

CODE NO	mm	h/mm	
E56-L1	195	0-15	1

### E56-L2

Axial Grip Pliers - LL Jaw



Suitable for clamping of two adjacent sheet steels, axial moving jaws allow for perpendicular grip

CODE NO	mm	h/mm	
E56-L2	220	0-15	1

### E56-J1

Axial Grip Pliers - J Jaw



Suitable for clamping of 90° bent forms, axial moving jaws allow for perpendicular grip

CODE NO	mm	h/mm	
E56-J1	210	0-15	1

### E56-J2

Axial Grip Pliers - JJ Jaw



Suitable for clamping of two 90° bent forms together, axial moving jaws allow for perpendicular grip

CODE NO	mm	h/mm	
E56-J2	235	0-15	1

### E56-W1

Axial Grip Pliers - W Jaw



Allows for clamping and spot welding of 4 adjacent spots while the tool is in position, axial moving jaws allow for perpendicular grip

CODE NO	mm	h/mm	
E56-W1	195	0-15	1

## Grip Pliers

### E50 Series

Grip Pliers (Curved Jaws)



For gripping and clamping of round materials

CODE NO	mm	Ø max. mm	
E50-16-0140	140	0-32	6
E50-16-0190	190	0-42	6
E50-16-0240	240	0-62	6
E50-16-0300	300	0-75	3

### E51-16-0235

Grip Pliers (Straight Jaws)



For gripping and clamping of flat materials

CODE NO	mm	max. mm	
E51-16-0235	235	0-63	6

### E52-16-0240

Grip Pliers (Prism Jaws)



For gripping and clamping of round or flat materials

CODE NO	mm	Ø max. mm	
E52-16-0240	240	0-62	6

### E53-16-0280

Welder's Grip Pliers (Fork Jaws)



For gripping and clamping of pipes, sheet steel, profiles etc., ideal for welders

CODE NO	mm	max. mm	
E53-16-0280	280	0-90	1

### E55-16-0290

Clamp Grip Pliers (C Jaw)



For gripping and clamping of angle sections and deep channels, ideal for welders

CODE NO	mm	max. mm	
E55-16-0290	290	0-100	1

### E70-225-2

Revolving Punch Pliers



For punching holes in leather, textile and plastics, 6 punch sizes in a revolver design

CODE NO	mm	mm	
E70-225-2	2.0-4.5	225	1

## Special Pliers

### E80 Series

Wire Twisting Pliers (Reversible)



YouTube Clip

For cutting and bending security wires, cross milled wire holding section, 45° offset narrow head, ratcheting mechanism

CODE NO	mm	mm	
E80-230R	0.5 - 1.6	230	1
E80-280R	0.5 - 1.6	280	1

### E80-230

Wire Twisting Pliers

**new**



Same structural specs as E80 series but in non-reversible design

CODE NO	mm	mm	
E80-230	0.5 - 1.6	230	1

### E81-180

Nut Pliers

**new**



For 3-13 mm spanner nuts, conical grip surface, for use in restricted areas

CODE NO	mm	
E81-180	180 - 7	6

### E82-190

Cleco Pliers

**new**



For use with all spring loaded Cleco fasteners and clamps

CODE NO	mm	
E82-190	190	6

# 06 Pliers and Cutters

## Cable Cutters / Scissors / Wire Rope Shears

**E60-51-0170**  
RZR Cable Shears (DuoTech Handles)



For cutting copper and aluminium cables  
Not suitable for steel wire and wire ropes

CODE NO	mm "	Ø mm	
E60-51-0170	170 - 6-1/2"	15	6

**E60-54-0170**  
RZR Cable Shears (PVC Sleeves)



For cutting copper and aluminium cables  
Not suitable for steel wire and wire ropes

CODE NO	mm "	Ø mm	
E60-54-0170	170 - 6-1/2"	15	6

**E60-41-0160**  
Cable Shears (DuoTech Handles)



For cutting copper and aluminium cables, double cut  
Not suitable for steel wire and wire ropes

CODE NO	mm "	Ø mm	
E60-41-0160	160 - 6"	10	6

**E60-44-0160**  
Cable Shears (PVC Sleeves)



For cutting copper and aluminium cables, double cut  
Not suitable for steel wire and wire ropes

CODE NO	mm "	Ø mm	
E60-44-0160	160 - 6"	10	6

**E62 Series**  
Ratchet Cable Shears



For cutting thicker copper and aluminum cables, ratchet shear mechanism for single handed, effortless cuts  
Not suitable for steel wire and wire ropes

CODE NO	mm	Ø mm	
E62-250	250	32	1
E62-280	280	52	1

**E62-R2 Series**  
Spare Blades (for E62 Series)



CODE NO		
E62-250R2	E62-250	1
E62-280R2	E62-280	1

**E63T Series**  
Cable Shears (Tubular Handles)



For cutting thicker copper and aluminum cables  
Not suitable for steel wire and wire ropes

CODE NO	mm	Ø mm	
E63T-320	320	22	1
E63T-530	530	32	1

**E63T-R Series**  
Spare Blades (for E63T Series)



CODE NO		
E63T-320R	E63T-320	1
E63T-530R	E63T-530	1

**G40-48-0145**  
Multi-Purpose Electrician's Shears



StainlessSteel



Ideal scissors for the electrician, micro toothed stainless steel blades, integrated cable cutter  
Not suitable for high voltage live working

CODE NO	mm	
G40-48-0145	145	6

**E61-K1160**  
KEVLAR Scissors



For cutting KEVLAR\* cables inside fiber optic cables, precision ground, milled cutting jaws

CODE NO	mm	
E61-K1160	160	12

**E64-54-0170**  
Wire Rope Shears (Forged Jaws)



For cutting wire ropes, high-leverage design: minimum cutting effort

CODE NO	mm	Ø mm	
E64-54-0170	170	4	6

**E64-44-0190**  
Wire Rope Shears (Punched Jaws) new



For cutting wire ropes, high-leverage design: minimum cutting effort

CODE NO	mm	Ø mm	
E64-44-0190	190	4	6

# Crimping Pliers

## E69-YT1

Crimping Pliers (for Insulated Terminals)



For crimping insulated terminals, precision crimping dies, self-releasing mechanism

CODE NO	mm <sup>2</sup>	mm	
E69-YT1	0.5 - 6.0	220	10

## E69-ES1

Crimping Pliers (for End Sleeves)



For crimping end sleeves (ferrules), precision crimping dies, self-releasing mechanism

CODE NO	mm <sup>2</sup>	mm	
E69-ES1	0.5 - 6.0	220	10

## E69-ESSQ

Crimping Tool (for End Sleeves-Square Form)



For square crimping of end sleeves (ferrules) up to 6 mm<sup>2</sup>, compact tool dimensions

CODE NO	mm <sup>2</sup>	AWG	mm	
E69-ESSQ	0.25 - 6	23-10	175	6

## E69-NT1

Crimping Pliers (for non-Insulated Terminals)



For crimping non-insulated terminals, precision crimping dies, self-releasing mechanism

CODE NO	mm <sup>2</sup>	mm	
E69-NT1	0.5 - 10.0	220	10

## E69-OB2

Crimping Pliers (for non-Insulated Open Plug Connectors)



For crimping non-insulated open plug connectors, precision crimping dies, self-releasing mechanism

CODE NO	mm <sup>2</sup>	mm	
E69-OB2	0.5 - 6.0	220	10

## E69F-ES Series

Crimping Pliers (for End Sleeves-Forged)



For crimping end sleeves (ferrules)

CODE NO	mm <sup>2</sup>	mm	
E69F-ES1	0.25 - 2.5	160	10
E69F-ES2	0.50 - 16.0	190	10

## E69-T046

Crimping Pliers for Western Plugs (for Phone / Data)



For crimping 6- and 8-pole Western plugs type RJ 11/12 and RJ 45, also cuts and strips telephone ribbon cables

CODE NO		mm	
E69-T046	6-8 pin	190	10

## E69-T468

Crimping Pliers for Western Plugs (for Phone / Data)



For crimping 4-, 6- and 8-pole Western plugs type RJ 10, RJ 11/12 and RJ 45, also cuts and strips telephone ribbon cables

CODE NO		mm	
E69-T468	4-6-8 pin	190	10

## E69F-SL

Crimping Pliers (for Scotchlok Connectors)



For crimping Scotchlok connectors, with opening spring

CODE NO	CAPACITY Ø mm	mm	
E69F-SL	0.4 - 1.1	150	6

# 06 Pliers and Cutters

## Circlip Pliers

Completely redesigned range of circlip pliers in industrial quality

- Inserted tips manufactured from spring steel: extra-long life
- Precision machined contact faces: No distortion, easy fitting
- Bolted joint for play-free operation
- Invisible spring



Forged in Germany



310 mm version is manufactured with turned tips instead of inserted tips illustrated above.

### E65 Series

External Circlip Pliers (Straight-with Spring)

DIN / ISO 5254 A, TS 60-10



For fitting and removal of external circlips, straight tips

CODE NO	mm	mm	
E65-44-0140/0	140	3 - 10	6
E65-44-0140	140	10 - 25	6
E65-44-0180	180	19 - 60	6
E65-44-0225	225	40 - 100	6
E65-44-0310	310	85 - 140	6

### E66 Series

External Circlip Pliers (Bent-with Spring)

DIN / ISO 5254 B, TS 60-10



For fitting and removal of external circlips, bent tips

CODE NO	mm	mm	
E66-44-0140/0	140	3 - 10	6
E66-44-0140	140	10 - 25	6
E66-44-0180	180	19 - 60	6
E66-44-0225	225	40 - 100	6
E66-44-0310	310	85 - 140	6

### E67 Series

Internal Circlip Pliers (Straight)

DIN / ISO 5256 C, TS 60-9



For fitting and removal of internal circlips, straight tips

CODE NO	mm	mm	
E67-44-0140/0	140	8 - 13	6
E67-44-0140	140	10 - 25	6
E67-44-0180	180	19 - 60	6
E67-44-0225	225	40 - 100	6
E67-44-0310	310	85 - 140	6

### E68 Series

Internal Circlip Pliers (Bent)

DIN / ISO 5256 D, TS 60-9



For fitting and removal of internal circlips, bent tips

CODE NO	mm	mm	
E68-44-0140/0	140	8 - 13	6
E68-44-0140	140	10 - 25	6
E68-44-0180	180	19 - 60	6
E68-44-0225	225	40 - 100	6
E68-44-0310	310	85 - 140	6

### E99-CP04A

4 Piece Circlip Pliers Set (in Roll Pouch)



CODE NO	
E99-CP04A	1



E65-44-0180



E67-44-0180



E66-44-0180



E68-44-0180

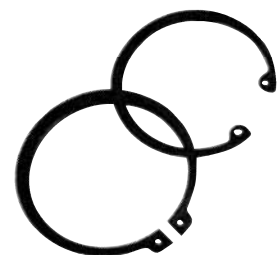

# 7



## VDE 1000V Insulated Tools and Multimeters



# 07 VDE 1000V Tools and Multimeters

Sübab, Piston ve Enjektör Grubu

## VDE 1000V Insulated Softgrip Screwdrivers

Ultimate safety with comfort



Precision machined, ultimate fit non-peel black finish tip

Dielectric tested blade insulation directly molded onto the blade thus safeguarding against electricity

Refined ergonomic design and premium quality plastic materials for a comfortable grip

2K Handle technology for high torque transmission with less stress



Every tool is individually tested in a water bath at 10.000 Volts according to DIN EN 60900, IEC 900 norms.



IEC 60900:2012



## VDE 1000V Insulated Softgrip Pliers

Ultimate safety with comfort



Larger teeth for holding circular objects i.e. screws, pipes, etc.

High performance cutting edges, extra hardened by special Ceta Form process

Plastic components resistant to all petroleum products

**DuoTech**  
ergonomic handles

# C-PLUS 1000V Screwdrivers (VDE)

## G01 Series

C-PLUS 1000V Slotted Screwdrivers (VDE)

VDE 0682 Teil 201, DIN ISO 2380



CODE NO	mm	mm	
G01-025-075	2.5	75	12
G01-030-100	3.0	100	12
G01-035-100	3.5	100	12
G01-040-100	4.0	100	12
G01-055-125	5.5	125	12
G01-065-150	6.5	150	12
G01-080-175	8.0	175	12

## G02 Series

C-PLUS 1000V Phillips Screwdrivers (VDE)

VDE 0682 Teil 201, DIN ISO 8764



CODE NO	+	mm	
G02-000-060	PH0	60	12
G02-001-080	PH1	80	12
G02-002-100	PH2	100	12
G02-002-150	PH2	150	12
G02-003-150	PH3	150	12

## G03 Series

C-PLUS 1000V Pozidriv Screwdrivers (VDE)

VDE 0682 Teil 201, DIN ISO 8764

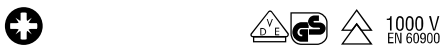

CODE NO	+	mm	
G03-000-060	PZ0	60	12
G03-001-080	PZ1	80	12
G03-002-100	PZ2	100	12
G03-002-150	PZ2	150	12
G03-003-150	PZ3	150	12

## G05 Series

C-PLUS 1000V Terminal Screwdrivers (VDE)

VDE 0682 Teil 201, DIN ISO 8764

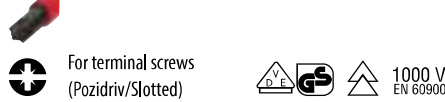

CODE NO	+	mm	
G05-001-080	#1	80	12
G05-002-100	#2	100	12

## G06 Series

C-PLUS 1000V Hexagon Screwdrivers (VDE)

VDE 0682 Teil 201



CODE NO	mm	mm	
G06-030-080	3	80	12
G06-040-080	4	80	12
G06-050-080	5	80	12
G06-060-100	6	100	12

## G07 Series

C-PLUS 1000V Nut Drivers (VDE)

VDE 0682 Teil 201, DIN 3125, ISO 2236



CODE NO	mm	mm	
G07-050-125	5	125	12
G07-055-125	5.5	125	12
G07-060-125	6	125	12
G07-070-125	7	125	12
G07-080-125	8	125	12
G07-090-125	9	125	12
G07-100-125	10	125	12
G07-110-125	11	125	12
G07-120-125	12	125	12
G07-130-125	13	125	12

## G26/BT

C-PLUS 1000V Bit Driver

VDE 0682 Teil 201



CODE NO	mm	mm	
G26/BT	1/4	100	12



# 07 VDE 1000V Tools and Multimeters

## C-PLUS 1000V Screwdriver Sets (VDE)

### G05-B02

2 Piece C-PLUS 1000V Terminal Screwdriver Set (VDE)



x2



CODE NO	
G05-B02	1

G05 #1x80, #2x100 mm

### G99-401

4 Piece C-PLUS 1000V Screwdriver Set (VDE) - Slotted/Phillips



x3

x1



CODE NO	
G99-401	1

G01 2.5x75, 4.0x100, 5.5x125 mm  
 G02 PH2x100 mm

### G99-402

4 Piece C-PLUS 1000V Screwdriver Set (VDE) - Slotted/Pozidriv



x3

x1



CODE NO	
G99-402	1

G01 2.5x75, 4.0x100, 5.5x125 mm  
 G03 PZ2x100 mm

### G07-B05

5 Piece C-PLUS 1000V Nut Driver Set (VDE)



x5



CODE NO	
G07-B05	1

G07 6.0x125, 7.0x125, 8.0x125, 10x125 mm, 13x125 mm

### G99-701

7 Piece C-PLUS 1000V Screwdriver Set (VDE) - Slotted/Phillips + Tester



x5

x2



CODE NO	
G99-701	1

G01 3.0x100, 4.0x100, 5.5x125, 6.5x150 mm  
 G02 PH1x80, PH2x100 mm  
 6105CP Voltage Tester, Short

### G99-702

7 Piece C-PLUS 1000V Screwdriver Set (VDE) - Slotted/Pozidriv + Tester



x5

x2



CODE NO	
G99-702	1

G01 3.0x100, 4.0x100, 5.5x125, 6.5x150 mm  
 G03 PZ1x80, PZ2x100 mm  
 6105CP Voltage Tester, Short

### G99-901

9 Piece C-PLUS 1000V Screwdriver Set (in Vinyl Wallet)



x5

x2

x2



CODE NO	
G99-901	1

G01 3.0x100, 4.0x100, 5.5x125, 6.5x150 mm

G03 PZ1x80, PZ2x100 mm

G02 PH1x80, PH2x100 mm

6105CP Voltage Tester (Short)

### SG99 Series

C-PLUS 1000V Screwdriver Set Display Packs (VDE)



CODE NO	
SG99-701	1
12x G99-701	
SG99-702	1
12x G99-702	

# Slimline 1000V Screwdrivers (VDE)

Unlimited access in critical working areas



Precision machined, ultimate fit non-peel black finish tip

Dielectric tested blade insulation directly molded onto the blade thus safeguarding against electricity

Refined ergonomic design and premium quality plastic materials for a comfortable grip

2K Handle technology for high torque transmission with less stress



Every tool is individually tested in a water bath at 10.000 Volts according to DIN EN 60900, IEC 900 norms.

## G01S Series C-PLUS 1000V Slotted Screwdrivers (VDE-Slimline)

VDE 0682 Teil 201, DIN ISO 2380



CODE NO	mm	mm	
G01S-035-100	3.5	100	12
G01S-040-100	4.0	100	12
G01S-055-125	5.5	125	12

## G05S-002-100 C-PLUS 1000V Terminal Screwdriver (VDE-Slimline)

VDE 0682 Teil 201, DIN ISO 8764



CODE NO		mm	
G05S-002-100	#2	100	12

## G02S Series C-PLUS 1000V Phillips Screwdrivers (VDE-Slimline)

VDE 0682 Teil 201, DIN ISO 8764

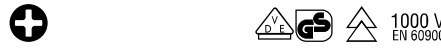

CODE NO		mm	
G02S-001-080	PH1	80	12
G02S-002-100	PH2	100	12

## G99-701S 7 Piece C-PLUS 1000V Screwdriver Set (VDE-Slimline) - Slotted/PH



- ⊖ x4
- ⊕ x2
- ⊕ x1



CODE NO	
G99-701S	1

- ⊖ G01S 3.5x100, 4.0x100, 5.5x125 mm
- ⊕ G02S PH1x80, PH2x100 mm
- ⊕ G05S #2x100 mm
- ⊖ 6105CP Voltage Tester, Short

## G03S Series C-PLUS 1000V Pozidriv Screwdrivers (VDE-Slimline)

VDE 0682 Teil 201, DIN ISO 8764



CODE NO		mm	
G03S-001-080	PZ1	80	12
G03S-002-100	PZ2	100	12

## G99-702S 7 Piece C-PLUS 1000V Screwdriver Set (VDE-Slimline) - Slotted/PZ



- ⊖ x4
- ⊕ x2
- ⊕ x1



CODE NO	
G99-702S	1

- ⊖ G01S 3.5x100, 4.0x100, 5.5x125 mm
- ⊕ G03S PZ1x80, PZ2x100 mm
- ⊕ G05S #2x100 mm
- ⊖ 6105CP Voltage Tester, Short

# 07 VDE 1000V Tools and Multimeters

## Voltage Testers

### New Voltage Testers

Maximum safety in an ergonomic design



- Handle in Ceta Form C-PLUS design
- Premium quality impact resistant plastic material
- High quality Silicon Chrome Vanadium steel blade
- Solid brass earthing contact



#### 6105CP C-PLUS Voltage Tester (VDE-Short)

VDE 0680/06, DIN 57680/6, TS 13108

**new**



For 110 to 250V, with clips

CODE NO	Ø mm	mm	
6105CP	3.0	140	24
<b>Display carded</b>			12

For display carded delivery = Item code + X

#### 6106CP C-PLUS Voltage Tester (VDE-Long)

VDE 0680/06, DIN 57680/6, TS 13108

**new**



For 110 to 250V

CODE NO	Ø mm	mm	
6106CP	3.5	170	24
<b>For display carded delivery = Item code + X</b>			12

#### 6105 Single-Pole Voltage Tester (Short)

DIN 57680/6, TS 13108



For 110 to 250V, with clips

CODE NO	Ø mm	mm	
6105	3.0	140	24

#### 6106 Single-Pole Voltage Tester (Long)

DIN 57680/6, TS 13108



For 110 to 250V

CODE NO	Ø mm	mm	
6106	3.5	180	24

#### 6106EX Single-Pole Voltage Tester (Long)



For 100V to 500V, highly durable blade

CODE NO	Ø mm	mm	
6106EX	4.0	187	24

#### G09-NC1 Non-Contact AC Voltage Detector



**(MAX. 1000 V)**



For 90V – 1000V AC, aural and visual notifications, CAT II insulation, 2 x 1.5V AAA batteries, 6 hours of battery time

CODE NO	mm	mm	
G09-NC1	4.5	152	20

#### G09-06 Universal Two-Pole Voltage Tester

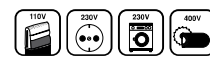

For testing domestic wiring, automobile circuitry and electronic equipment, plastic body with LED indicators

CODE NO	AC(V)	DC(V)	
G09-06	110-380	12-48	10

#### GRT-M Series Rethreading Tools



For cleaning out and cutting damaged threads in electrical boxes, precision ground HSS tap

CODE NO	M SIZE	mm	
GRT-M35	M3.5x0.6	118	12
GRT-M40	M4.0x0.7	118	12

# 1000V Pliers / Cutters (VDE)

## G10 Series

1000V Combination Pliers (VDE)

VDE 0682 Teil 201, DIN ISO 5746



Ideal for live working up to 1000V AC or 1500V DC, suitable for cutting soft and hard wire

CODE NO	mm "	Ø mm	
G10-18-0160	160 - 6"	1.8	6
G10-18-0180	180 - 7"	2.0	6
G10-18-0200	200 - 8"	2.5	6

## G12 Series

1000V Diagonal Cutters (VDE)

VDE 0682 Teil 201, DIN ISO 5749



Ideal for live working up to 1000V AC or 1500V DC, suitable for cutting soft and hard wire

CODE NO	mm "	Ø mm	
G12-18-0140	140 - 5-1/2"	1.8	6
G12-18-0160	160 - 6"	2.0	6
G12-18-0180	180 - 7"	2.5	6

## G14 Series

1000V Power Diagonal Cutters (VDE)

VDE 0682 Teil 201, DIN ISO 5749



**piano plus**



Ideal for live working up to 1000V AC or 1500V DC, suitable for cutting all wires (incl. piano wire)

CODE NO	mm "	Ø mm	
G14-18-0180	180 - 7"	2.0	6
G14-18-0200	200 - 8"	2.2	6

## G10H Series

1000V High Leverage Combination Pliers (VDE)

VDE 0682 Teil 201, DIN ISO 5746



Ideal for live working up to 1000V AC or 1500V DC, dramatically less effort required for cutting compared to traditional pliers, suitable for cutting soft and hard wire

CODE NO	mm "	Ø mm	
G10H-18-0180	180 - 7"	2.0	6
G10H-18-0200	200 - 8"	2.5	6

## G12H-18-0160

1000V High Leverage Diagonal Cutter (VDE)

VDE 0682 Teil 201, DIN ISO 5749

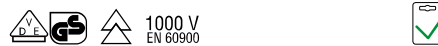

Ideal for live working up to 1000V AC or 1500V DC, dramatically less effort required for cutting compared to traditional cutters, suitable for cutting soft and hard wire

CODE NO	mm "	Ø mm	
G12H-18-0160	160 - 6"	2.0	6

## SG18-24

24 Piece 1000V Pliers (VDE) Display Pack



CODE NO	
SG18-24	1



# 07 VDE 1000V Tools and Multimeters

## 1000V Pliers / Cable Shears (VDE) / Control Cabinet Keys

### G15 Series

1000V Long Nose Pliers (VDE)

VDE 0682 Teil 201, DIN ISO 5745



Ideal for live working up to 1000V AC or 1500V DC, suitable for cutting soft and hard wire

CODE NO	mm "	Ø mm	6
G15-18-0160	160 - 6"	1.6	6
G15-18-0200	200 - 8"	1.6	6

### G17-18-0160

1000V Flat Nose Pliers (VDE)

VDE 0682 Teil 201, DIN ISO 5745



Ideal for live working up to 1000V AC or 1500V DC, serrated gripping jaws

CODE NO	mm "	6
G17-18-0160	160 - 6"	6

### G20-18-0160

1000V Wire Stripping Pliers (VDE)

VDE 0682 Teil 201



Ideal for live working up to 1000V AC or 1500V DC, for stripping of single / multi-strand conductors' plastic insulations

CODE NO	mm "	mm <sup>2</sup>	6
G20-18-0160	160 - 6"	10	6

### G16 Series

1000V Bent Long Nose Pliers (VDE)

VDE 0682 Teil 201, DIN ISO 5745



Ideal for live working up to 1000V AC or 1500V DC, suitable for cutting soft and hard wire

CODE NO	mm "	Ø mm	6
G16-18-0160	160 - 6"	1.6	6
G16-18-0200	200 - 8"	1.6	6

### G18-18-0160

1000V Round Nose Pliers (VDE)

VDE 0682 Teil 201, DIN ISO 5745



Ideal for live working up to 1000V AC or 1500V DC, for bending wire loops

CODE NO	mm "	6
G18-18-0160	160 - 6"	6

### G25-58-0250

1000V Water Pump Pliers (VDE)

VDE 0682 Teil 201, DIN ISO 8976



Ideal for live working up to 1000V AC or 1500V DC, 9-position adjustment, box-joint design

CODE NO	mm "	Ø max. mm	6
G25-58-0250	250 - 10"	28	6

### G30-58-0170

RZR Series 1000V Cable Shears (VDE)

VDE 0682 Teil 201



Ideal for live working up to 1000V AC or 1500V DC, for cutting copper and aluminum cables

Not suitable for steel wire and wire ropes

CODE NO	mm "	Ø max. mm	6
G30-58-0170	170 - 6-1/2"	15	6

### G30-48-0160

1000V Cable Shears (VDE)

VDE 0682 Teil 201



Ideal for live working up to 1000V AC or 1500V DC, for cutting copper and aluminum cables

Not suitable for steel wire and wire ropes

CODE NO	mm "	Ø mm	6
G30-48-0160	160 - 6"	10	6

### E75-081

Control Cabinet Key - 8 Profiles

new

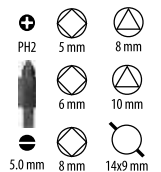
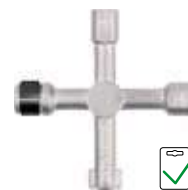

For control cabinets and shut-off systems in supply of gas, water and electricity, die-casted zinc

CODE NO	mm	12
E75-081	71	12

# 1000V Tool Sets (VDE)

## G99-18-02A

2 Piece 1000V Pliers Set (VDE)



G10-18-0180 (180 mm)  
G12-18-0160 (160 mm)



CODE NO



G99-18-02A

1

## G99-18-03A

3 Piece 1000V Pliers Set (VDE)



G10-18-0180 (180 mm)  
G12-18-0160 (160 mm)  
G15-18-0160 (160 mm)



CODE NO



G99-18-03A

1

## G99-18-05 Series

5 Piece 1000V Pliers and Screwdriver Sets (VDE)

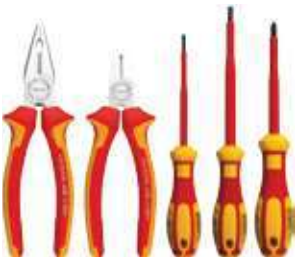

1000 V  
EN 60900



CODE NO



G99-18-05PH

1

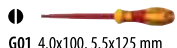

G01 4.0x100, 5.5x125 mm

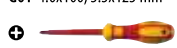

G02 PH2x100 mm

G12-18-0160

G99-18-05PZ

1

Content: Same as G99-18-05PH but with Pozidriv screwdrivers instead of Phillips

## G99-18-W09 Series

9 Piece 1000V Pliers and Screwdriver Sets (VDE-in Vinyl Wallet)



1000 V  
EN 60900



CODE NO



G99-18-W09PH

1



G01 2.5x75, 4x100, 5.5x125 mm

G10-18-0180

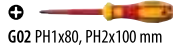

G02 PH1x80, PH2x100 mm

G12-18-0160



6105CP Voltage Tester (Short)

G15-18-0160

G99-18-W09PZ

1

Content: Same as G99-18-W09PH but with Pozidriv screwdrivers instead of Phillips

## G99-18-W12 Series

12 Piece 1000V Pliers and Screwdriver Sets (VDE-in Vinyl Wallet)



1000 V  
EN 60900



CODE NO



G99-18-W12PH

1



G01 2.5x75, 4x100, 5.5x125 mm

G10-18-0180

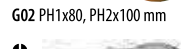

G02 PH1x80, PH2x100 mm

G12-18-0160

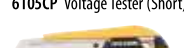

6105CP Voltage Tester (Short)

G15-18-0160



J45C

E25-AS06 6 mm2

P05-0316 3mx16mm

G99-18-W12PZ

1

Content: Same as G99-18-W12PH but with Pozidriv screwdriver instead of Phillips

# 07 VDE 1000V Tools and Multimeters

## Multimeters and Clampmeters

### G80-AAC1

Digital Multimeter (AC/DC Current-Auto Ranging)



**TRUE  
RMS**



NCV function, MAX/MIN mode, data hold, backlit display, REL mode, frequency/duty cycle, auto power off and beeper alarm, anti-high voltage circuit design, 1000V CATII, large LCD display, 2xAAA batteries

CODE NO		
G80-AAC1	1	

FUNCTION	INTERVALS	ACCURACY
DC Voltage	400mV/4V/40V/400V/1000V	±(0.5%+5)
AC Voltage	400mV/4V/40V/400V/750V	±(0.8%+10)
DC Current	400uA/4000uA/40mA/400mA/4A/20A	±(1.0%+5)
AC Current	400uA/4000uA/40mA/400mA/4A/20A	±(1.5%+10)
Resistance	400Ω/4kΩ/40kΩ/400kΩ/4MΩ/40MΩ	±(0.8%+2)
Capacitance	4nF/40nF/400nF/4uF/40uF/200uF	±(2.5%+5)
	40nF/400nF/4uF/40uF/400uF/4mF/40mF	
Frequency	10Hz/100Hz/1kHz/10kHz/100kHz/1MHz	±(0.5%+4)
Temperature	-40°C~1000°C	±(1.0%+5)
	-OFF ~1832°F	±(1.0%+5)

### G80-MDC1

Digital Multimeter (DC Current-Manual Ranging)



Voltage (AC/DC), current (DC) and resistance functions, backlit LCD display, 1000V CAT IV, 1x9V battery

CODE NO		
G80-MDC1	1	

FUNCTION	INTERVALS	ACCURACY
DC Voltage	200mV/2V/20V/200V/600V	±(0.5%+4)
AC Voltage	200V/600V	±(1.2%+10)
DC Current	20uA/200uA/2mA/20mA/200mA/10A	±(0.8%+3)

### G85-ADC1

Digital Clampmeter (AC/DC Current-Auto Ranging)



**TRUE  
RMS**



MAX/MIN mode, data hold, clamp jaw lighting, backlit display, REL mode, frequency/duty cycle, auto power off and warning functions, anti-high voltage circuit design, 600V CATIII, large LCD display, 2xAAA batteries

CODE NO	Clamp Span max. mm	
G85-ADC1	52	1

FUNCTION	INTERVALS	ACCURACY
DC Voltage	400mV/4V/40V/400V/1000V	±(0.5%+5)
AC Voltage	400mV/4V/40V/400V/750V	±(1.0%+5)
DC Current	400A/1000A	±(2.0%+5)
AC Current	400A/1000A	±(2.0%+5)
Resistance	400Ω/4kΩ/40kΩ/400kΩ/4MΩ/40MΩ	±(0.8%+3)
Capacitance	4nF/40nF/400nF/4uF/40uF	±(3.5%+10)
Frequency	100Hz/1kHz/10kHz/100kHz/1MHz/10MHz	±(2%+5)
Temperature	-40°C~750°C	±(1.0%+5)

### G85-AAC1

Digital Clampmeter (AC Current-Auto Ranging)



**TRUE  
RMS**



MAX/MIN mode, data hold, clamp jaw lighting, backlit display, REL mode, frequency/duty cycle, auto power off and warning functions, anti-high voltage circuit design, 600V CATIII, large LCD display, 2xAAA batteries

CODE NO	Clamp Span max. mm	
G85-AAC1	52	1

FUNCTION	INTERVALS	ACCURACY
DC Voltage	200mV/2V/20V/200V/1000V	±(0.5%+5)
AC Voltage	200mV/2V/20V/200V/750V	±(1.0%+5)
AC Current	200A/1000A	±(2.0%+5)
Resistance	200Ω/2kΩ/20kΩ/200kΩ/2MΩ/20MΩ	±(0.8%+3)
Temperature	-40°C~1000°C	±(1.0%+5)

## Infrared Thermometer

### G90-IR550

Infrared Thermometer



Built-in laser pointer, backlit LCD display, data storage, max/min/average/DIF data storage, high/low heat alarm function, alert function on pre-set temperature, set to zero function, low battery warning, auto power off, 1x9V battery

CODE NO		
G90-IR550	1	

TECHNICAL SPECIFICATIONS		
Measurement Range	-50°C~550°C / -58°F~1022°F	
Accuracy (Deviation)	±1.5°C or ±1.5%	
Measurement Unit Selection	°C / °F	
Distance / Target Ratio	D:S=12:1	
Auto power off	Appr. 6 Sec.	
Measurement speed	≤ 0.5 seconds	
Adjustable ignition ratio	0.1 ~ 1	
Led screen display	3 digits	
Power consumption	≤50mW	
Battery	9V battery (6F22or equivalent)	

8

**CETA FORM**®

Electronic Screwdrivers and Pliers



# 08 Electronic Screwdrivers and Pliers

## Electronics Screwdrivers



Precision machined, ultimate fit, non-peel black finish tip

Highly durable, Chrome Vanadium Molybdenum steel

Soft-grip handle for extra ergonomics

Ultra-slim grip enables fast twisting and finger-tip accuracy

Broad handle base provides increased grip

Minimum friction with free-rotating cap

## Electronics Pliers



Hot drop forged, hardened and tempered steel

Replaceable sheet steel springs

Induction hardened, precision milled cutting edges

Refined ergonomic handle design for a comfortable grip

2K Handle technology for a silk smooth feeling



Box joint construction

Welded sheet steel spring mechanism

Induction hardened, precision milled cutting edges

Hot drop forged, hardened and tempered quality stainless steel

PVC handle

# C-TRONIC Electronics Screwdrivers

## H01 Series

Electronics Slotted Screwdrivers

DIN 8320, DIN 5264



CODE NO	mm	mm	
H01-12-040	1.2	40	12
H01-15-040	1.5	40	12
H01-18-060	1.8	60	12
H01-20-060	2.0	60	12
H01-20-100	2.0	100	12
H01-25-080	2.5	80	12
H01-25-100	2.5	100	12
H01-30-080	3.0	80	12
H01-30-100	3.0	100	12
H01-30-150	3.0	150	12
H01-35-080	3.5	80	12
H01-40-080	4.0	80	12
H01-40-100	4.0	100	12
H01-40-150	4.0	150	12

## H02 Series

Electronics Phillips Screwdrivers

DIN 5260, ISO 8764



CODE NO		mm	
H02-00-060	PH00	60	12
H02-0-060	PH0	60	12
H02-1-080	PH1	80	12

## H99-12-06

6 Piece Electronics Screwdriver Set - Slotted/Phillips



CODE NO	
H99-12-06	1

- H01 1.5x40, 2.0x60, 2.5x80, 3.0x80 mm
- ⊕ H02 PH00x60, PH0x60 mm

## H03 Series

Electronics Pozidriv Screwdrivers

DIN ISO 8764-1, TS 59-5



CODE NO		mm	
H03-0-060	PZ0	60	12
H03-1-080	PZ1	80	12

## H04 Series

Electronics TORX Screwdrivers



CODE NO		mm	
H04-04-040	T4	40	12
H04-05-040	T5	40	12
H04-06-040	T6	40	12
H04-07-040	T7	40	12
H04-08-040	T8	40	12
H04-09-060	T9	60	12
H04-10-060	T10	60	12
H04-15-060	T15	60	12
H04-20-060	T20	60	12

## H05 Series

Electronics Pentalobe Screwdrivers



For Pentalobe screws which are used on Apple products

CODE NO		mm	
H05-02-040	P2	40	12
H05-05-040	P5	40	12

## H99-04-06

6 Piece Electronics Screwdriver Set - TORX



CODE NO	
H99-04-06	1

- ⊛ H04 T5x40, T6x40, T7x40, T8x40, T9x60, T10x60 mm

## H06 Series

Electronics Hexagon Screwdrivers

new



CODE NO	mm	"	mm	
H06-15-040	1.5	-	40	12
H06-20-060	2.0	5/64	60	12
H06-25-080	2.5	-	80	12
H06-30-080	3.0	-	80	12
H06A-0116	-	1/16	40	12
H06A-0332	-	3/32	80	12
H06A-0764	-	7/64	80	12

## H99-JK-06

6 Piece Jewellers Screwdriver Set

new



CODE NO	
H99-JK-06	1

- 1.4x85, 2.0x90, 2.4x100, 3.0x110mm
- ⊕ PH0x100, PH1x110 mm

## H99-06-06

6 Piece Electronics Screwdriver Set - Hexagon

new



CODE NO	
H99-06-06	1

- ⊙ H06 1.5x40, 2 (5/64")x60, 2.5x80, 3x80, 3/32"x80, 7/64"x80 mm

# 08 Electronic Screwdrivers and Pliers

## C-TRONIC Comfort Electronics Pliers

### H20S-120SB

Electronics Diagonal Cutter (Small Bevel)

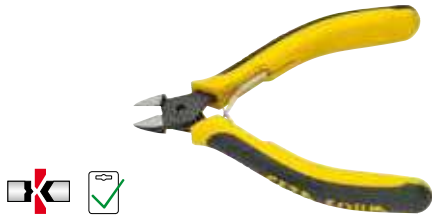

Cutting edges for soft and medium hard wire, screw joint design

CODE NO	mm	Ø mm	
H20S-120SB	120	1.0	6

### H20T-120SB

Electronics Diagonal Cutter (Tapered Head-Small Bevel)

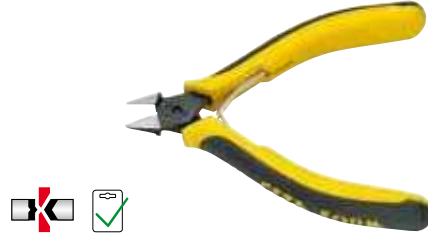

Cutting edges for soft and medium hard wire, screw joint design

CODE NO	mm	Ø mm	
H20T-120SB	120	1.0	6

### H21N-130SB

Electronics Oblique End Cutter (Extra Narrow Head)



Cutting edges for soft and medium hard wire, offset head, box-joint design

CODE NO	mm	Ø mm	
H21N-130SB	130	1.0	6

### H20S-120FL

Electronics Diagonal Cutter (Flush Cut)



Cutting edges for soft and medium hard wire, screw joint design

CODE NO	mm	Ø mm	
H20S-120FL	120	1.0	6

### H22-130

Electronics Combination Pliers

new



Cutting edges for soft and medium hard wire, lap joint design

CODE NO	mm	Ø mm	
H22-130	130	1.0	6

### H23S-130

Electronics Short Needle Nose Pliers (Serrated)

new



Serrated gripping jaws, box-joint design

CODE NO	mm		
H23S-130	130		6

### H20C-118SB

Electronics Diagonal Cutter (Slim Head-Small Bevel)



Cutting edges for soft and medium hard wire, screw joint design

CODE NO	mm	Ø mm	
H20C-118SB	118	1.0	6

### H21S-125SB

Electronics End Cutter



Cutting edges for soft and medium hard wire, box-joint design

CODE NO	mm	Ø mm	
H21S-125SB	125	1.0	6

### H23F-130

ex code H23-130

Electronics Short Needle Nose Pliers (Flat)

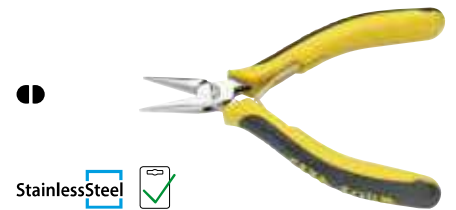

Flat gripping jaws, box-joint design

CODE NO	mm		
H23F-130	130		6

# C-TRONIC Comfort Electronics Pliers

**H24-130**  
Electronics Bent Needle Nose Pliers

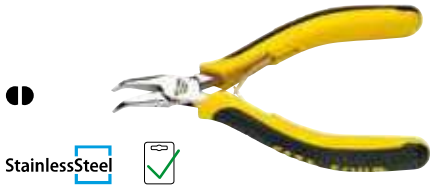

Serrated gripping jaws, box-joint design

CODE NO	mm	
H24-130	130	6

**H26-130**  
Electronics Round Nose Pliers



For forming wire loops, box-joint design

CODE NO	mm	
H26-130	130	6

**H20-W04**  
4 Piece Electronics Pliers Set (in Vinyl Wallet)



CODE NO	
H20-W04	1
<b>4PC:</b> H20S-120SB, H21S-125SB, H23S-130, H27-130	

**H25-155**  
Electronics Long Needle Nose Pliers



Serrated gripping jaws, box-joint design

CODE NO	mm	
H25-155	155	6

**H27-130**  
Electronics Flat Nose Pliers



Flat gripping jaws, box-joint design

CODE NO	mm	
H27-130	130	6

**H20-W06**  
6 Piece Electronics Pliers Set (in Vinyl Wallet)



CODE NO	
H20-W06	1
<b>6 PC:</b> H20S-120SB, H21S-125SB, H23S-130, H25-155, H26-130, H27-130	



# 08 Electronic Screwdrivers and Pliers

## C-TRONIC Basic Electronics Pliers

### H30S-110SB

Electronics Diagonal Cutters (Small Bevel)



StainlessSteel



Cutting edges for soft and medium hard wire, box-joint design

CODE NO	mm	∅ mm	
H30S-110SB	110	1.0	6
	For display carded delivery = Item code + X		6

### H30T-110SB

Electronics Diagonal Cutters (Tapered Head-Small Bevel)



StainlessSteel



Cutting edges for soft and medium hard wire, box-joint design

CODE NO	mm	∅ mm	
H30T-110SB	110	1.0	6
	For display carded delivery = Item code + X		6

### H33S-120

Electronics Short Needle Nose Pliers (Serrated)



StainlessSteel



Serrated gripping jaws, box-joint design

CODE NO	mm	
H33S-120	120	6
	For display carded delivery = Item code + X	

### H30S-110FL

Electronics Diagonal Cutters (Flush Cut)



StainlessSteel



Cutting edges for soft and medium hard wire, box-joint design

CODE NO	mm	∅ mm	
H30S-110FL	110	1.0	6
	For display carded delivery = Item code + X		6

### H31S-120SB

Electronics End Cutter



StainlessSteel



Cutting edges for soft and medium hard wire, box-joint design

CODE NO	mm	∅ mm	
H31S-120SB	120	1.0	6
	For display carded delivery = Item code + X		6

### H33F-120

Electronics Short Needle Nose Pliers (Flat)



StainlessSteel



Flat gripping jaws, box-joint design

CODE NO	mm	
H33F-120	120	6
	For display carded delivery = Item code + X	

### H30C-105SB

Electronics Diagonal Cutters (Slim Head-Small Bevel)



StainlessSteel



Cutting edges for soft and medium hard wire, box-joint design

CODE NO	mm	∅ mm	
H30C-105SB	105	1.0	6
	For display carded delivery = Item code + X		6

### H31N-120SB

Electronics Oblique End Cutter (Extra Narrow Head)



StainlessSteel



Cutting edges for soft and medium hard wire, offset head, box-joint design

CODE NO	mm	∅ mm	
H31N-120SB	120	1.0	6
	For display carded delivery = Item code + X		6

### H34S-115

Electronics Bent Needle Nose Pliers



StainlessSteel



Serrated gripping jaws, box-joint design

CODE NO	mm	
H34S-115	115	6
	For display carded delivery = Item code + X	

# C-TRONIC Basic Electronics Pliers

## H35S-140 Electronics Long Needle Nose Pliers



StainlessSteel

Serrated gripping jaws, box-joint design

CODE NO	mm	
H35S-140	140	6
	For display carded delivery = Item code + X	6

## H36-120 Electronics Round Nose Pliers

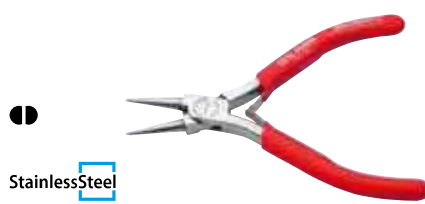

StainlessSteel

For forming wire loops, box-joint design

CODE NO	mm	
H36-120	120	6
	For display carded delivery = Item code + X	6

## H37-120 Electronics Flat Nose Pliers

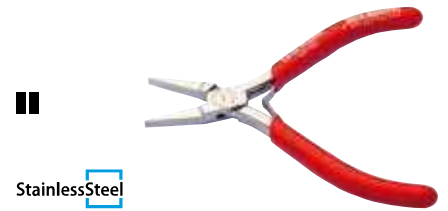

StainlessSteel

Flat gripping jaws, box-joint design

CODE NO	mm	
H37-120	120	6
	For display carded delivery = Item code + X	6

## H30-W04 4 Piece C-TRONIC Basic Electronics Pliers Set (in Vinyl Wallet)



StainlessSteel

CODE NO	
H30-W04	1
<b>4 PC:</b> H30S-110SB, H31S-120SB, H33S-120, H37-120	

## H30-W06 6 Piece C-TRONIC Basic Electronics Pliers Set (in Vinyl Wallet)



StainlessSteel

CODE NO	
H30-W06	1
<b>6 PC:</b> H30S-110SB, H31S-120SB, H33S-120, H35S-140, H36-120, H37-120	

## H30-W10 10 Piece C-TRONIC Electronics Pliers and Screwdriver Set (in Vinyl Wallet)



CODE NO	
H30-W10	1



H30S-110SB



H33S-120



H35S-140

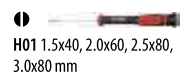

**H01** 1.5x40, 2.0x60, 2.5x80, 3.0x80 mm

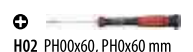

**H02** PH00x60, PH0x60 mm



H43-120-SA



# 08 Electronic Screwdrivers and Pliers

## Professional Tweezers

Ceta Form presents its new tweezers range developed especially to professional requirements. The new programme comprises precision, general purpose, cross-over and insulated product families. The large range addresses requirements in electronics, watchmaking, computer and telecommunication sectors.



### StainlessSteel

- Precision

For precision assembly work, non-serrated slim tips. Anti-magnetic, acid-resistant stainless steel

- General Purpose

Universal use, serrated narrow tips. Stainless steel.

- Insulated

PVC insulated, serrated, wide and round tips. Stainless steel.

- Cross-Over

For effortless gripping of small parts. Stainless steel.

#### H40-AA-SA Pointed Tweezers



Suitable for precise assembly, straight jaws, thin tips, anti-magnetic, acid-resistant, stainless steel

CODE NO	mm	
H40-AA-SA	130	1

#### H40-00-SA Pointed Tweezers



Suitable for precise assembly, straight jaws, thin tips, anti-magnetic, acid-resistant, stainless steel

CODE NO	mm	
H40-00-SA	120	1

#### H40-1-SA Pointed Tweezers



Suitable for precise assembly, straight jaws, thin tips, anti-magnetic, acid-resistant, stainless steel

CODE NO	mm	
H40-1-SA	120	1

#### H40-3C-SA Pointed Tweezers



Suitable for precise assembly, straight jaws, thin tips, anti-magnetic, acid-resistant, stainless steel

CODE NO	mm	
H40-3C-SA	110	1

#### H40-5-SA Needle Pointed Tweezers



Suitable for very precise assembly, straight jaws, extra thin tips, anti-magnetic, acid-resistant, stainless steel

CODE NO	mm	
H40-5-SA	110	1

#### H40-7-SA Needle Pointed Tweezers (Bent)



Suitable for very precise assembly, bent jaws, extra thin tips, anti-magnetic, acid-resistant, stainless steel

CODE NO	mm	
H40-7-SA	120	1

# Professional Tweezers

## H40-2A-SA

Round Slim Shape Tweezers



2 mm wide rounded tips, straight jaws, anti-magnetic, acid-resistant, stainless steel

CODE NO	mm	
H40-2A-SA	115	1

## H43G-150-SA

Pointed Tweezers (Centering Pin)



Universal use, thin tips, toothed jaws, serrated holding area, stainless steel

CODE NO	mm	
H43G-150-SA	150	1

## H43G-150B-SA

Pointed Tweezers (Centering Pin-Bent)



Universal use, bent thin tips, toothed jaws, serrated holding area, stainless steel

CODE NO	mm	
H43G-150B-SA	155	1

## H43 Series

Blunt Shape Tweezers- Serrated



Universal use, wide rounded tips, toothed jaws, serrated holding area, stainless steel

CODE NO	mm	
H43-120-SA	120	1
H43-140-SA	140	1

## H44-160-SA

Cross-Over Tweezers



Suitable for picking up very small objects without applying high force, stainless steel

CODE NO	mm	
H44-160-SA	160	1

## H44-160B-SA

Cross-Over Tweezers (Bent)



Suitable for picking up very small objects without applying high force, stainless steel

CODE NO	mm	
H44-160B-SA	160	1

## H44T-160-SA

Cross-Over Tweezers



Suitable for picking up very small objects without applying high force, stainless steel

CODE NO	mm	
H44T-160-SA	160	1

## H43-125B-SA

Blunt Shape Tweezers - Serrated (Bent)



Universal use, wide rounded bent tips, toothed jaws, serrated holding area, stainless steel

CODE NO	mm	
H43-125B-SA	125	1

## H45D-150-SA

Insulated Tweezers



PVC insulated, wide rounded tips, toothed jaws, stainless steel

CODE NO	mm	
H45D-150-SA	150	1

## H45D-150B-SA

Insulated Tweezers (Bent)



PVC insulated, wide rounded bent tips, toothed jaws, stainless steel

CODE NO	mm	
H45D-150B-SA	150	1

## H40-R04

4 Piece Tweezers Set



CODE NO	
H40-R04	1

H44-115-SA

H43-120-SA

H43T-110-SA

H43-125B-SA

# 08 Electronic Screwdrivers and Pliers

## Soldering Tools

**H55**  
Gas Soldering Iron



Adjustable power, spare tip available

CODE NO	mm	
H55	185	1

**H55-SC010**  
Spare Conical Tip (for H55)



CODE NO	mm	
H55-SC010	1.0	6•

**H59AL**  
Aluminum Desoldering Pump (PTFE Nozzle)



CODE NO	mm	
H59AL	195	6•

**H60-3**  
3 Piece Soldering Aid Kit



Hook, reamer, knife, scraper, brush and fork tips in a single kit

CODE NO	mm	
H60-3	175	1

**H56-0710**  
Soldering Wire - Unleaded / 100 gr



Sn99.3 Cu0.7

CODE NO	mm	
H56-0710	0.7	1

**H56-1220**  
Soldering Wire - Unleaded / 200 gr



Sn99.3 Cu0.7

CODE NO	mm	
H56-1220	1.2	1

**H57-1516**  
Desoldering Braid



CODE NO	W / mm	m	
H57-1516	1.5	1.6	1

**H62-YC**  
Anti Static Wrist Strap (with Cord)



Protection from static electricity, resistance: < 10K Ohm (Wrist Strap), 1M Ohm 10% (Cord)

CODE NO		
H62-YC		1

**H63**  
Fiberglass Scratch Brush



For cleaning of contacts, rotary mechanism, plastic casing

CODE NO	mm	
H63	120	6•

**H64**  
Dust Brush



Black bristles, wooden handle

CODE NO	mm	
H64	160	6•

**H65-3**  
3 Piece Antistatic Alignment Kit



CODE NO		
H65-3		1

**H65-10**  
10 Piece Plastic Alignment Kit



CODE NO		
H65-10		1

# 9

## Plumbing Tools

**CETA FORM**®

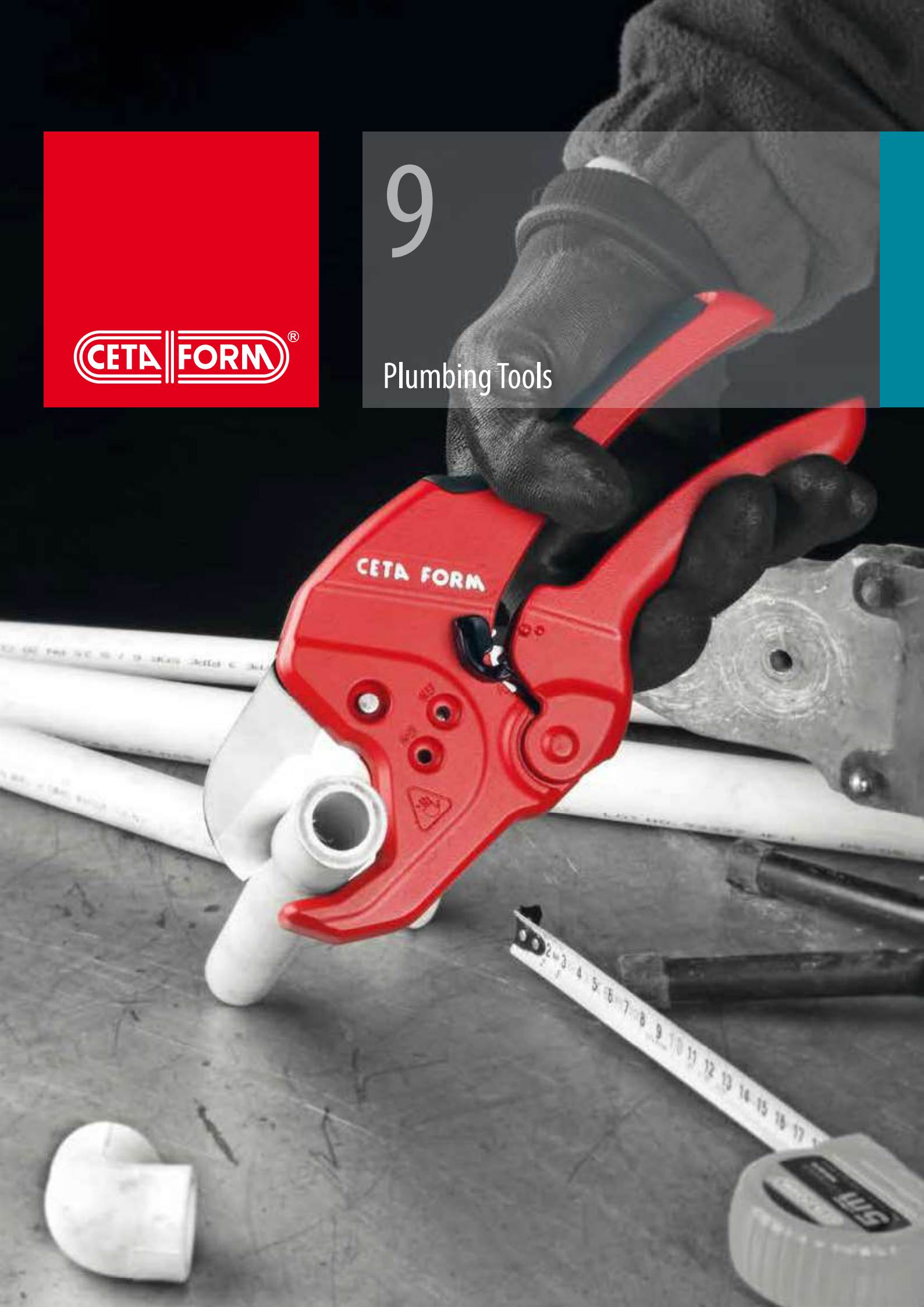

# 09 Plumbing Tools

## Pipe Wrenches

### I01 Series

Swedish Pattern Pipe Wrenches (90° Jaws)

DIN 5234, TS 3796-A



Jaws set at 90°

CODE NO	∅ "	mm	
I01-10	1	320	1
I01-15	1-1/2	425	1
I01-20	2	555	1

### I02 Series

Swedish Pattern Pipe Wrenches (S Jaws)

DIN 5234, TS 3796-A

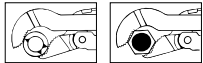



S-shaped jaws set at 90°

CODE NO	∅ "	mm	
I02-10	1	320	1
I02-15	1-1/2	425	1
I02-20	2	535	1

### I01-/A Series

Spare Nuts (for I01, I02, I03 Series)

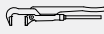

CODE NO		
I01-10/A	1"	6
I01-15/A	1-1/2"	6
I01-20/A	2"	6

### I06 Series

Heavy Duty Pipe Wrenches





Especially for heavy duty work

CODE NO	∅ "	mm	
I06-10	1-1/2	250	1
I06-12	2	300	1
I06-14	2	350	1
I06-18	2-1/2	450	1
I06-24	3	600	1
I06-36	5	900	1

### I06-A Series

Spare Heads (for I06 Series)





CODE NO		
I06-10/A	I06-10	1
I06-12/A	I06-12	1
I06-14/A	I06-14	1
I06-18/A	I06-18	1
I06-24/A	I06-24	1
I06-36/A	I06-36	1

### I06/B Series

Spare Nuts (for I06 Series)

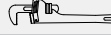

CODE NO		
I06-10/B	I06-10	6
I06-12/B	I06-12	6
I06-14/B	I06-14	6
I06-18/B	I06-18	6
I06-24/B	I06-24	6
I06-36/B	I06-36	6

### I11 Series

Chain Pipe Wrenches





Twin serration reversible jaws

CODE NO	∅ "	mm	
I11-40	4	900	1
I11-60	6	1000	1

### I11-R Series

Spare Chains (for I11 Series)

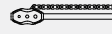

CODE NO		
I11-40R	I11-40	1
I11-60R	I11-60	1

### I12-40

Mini Chain Pipe Wrench

**new**  
design





Twin serration jaws, forged

CODE NO	∅ "	mm	
I12-40	4	300	1

### I12-40R

Spare Chain (for I12-40)



CODE NO		
I12-40R	I12-40	1



# PPRC Pipe Cutters

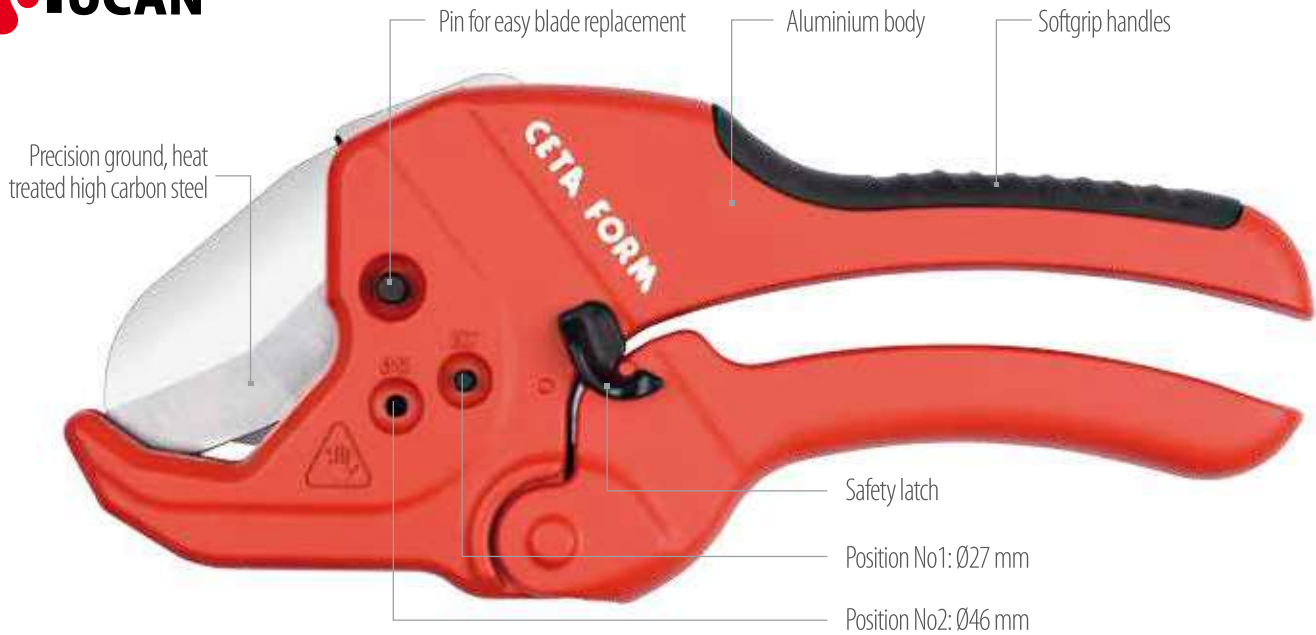

- For PE, PP, PVC, PVDF, PB, EXP and VPE plastic pipes
- Smooth and precise cut
- One-handed operation
- Can also be used for hoses

2 opening positions adjustable by a spring loaded pin



## I21-2 Series PPRC Pipe Cutters (Adjustable Capacity)



For cutting PVC, PP, PE, PVDF, PB, PEX and VPE plastic pipes

CODE NO	Ø max. mm	mm	
I21-42-2	42	230	6
I21-63-2	63	290	3

## I21-2R Series Spare Blades (for I21-2 Series)



CODE NO		
I21-42-2R	I21-42-2	1
I21-63-2R	I21-63-2	1

## I21-63 PPRC Pipe Cutter



For cutting PVC, PP, PE, PVDF, PB, PEX and VPE plastic pipes

CODE NO	Ø max. mm	mm	
I21-63	63	280	1

## I21-63R Spare Blade (for I21-63)



CODE NO		
I21-63R	I21-63	1

## I20-190 PPRC Pipe Cutter - Basic



For cutting PVC, PP, PE, PVDF, PB, PEX and VPE plastic pipes

CODE NO	Ø max. mm	mm	
I20-190	42	190	6

## I20-190R Spare Blade (for I20-190)



CODE NO		
I20-190R	I20-190	1

# 09 Plumbing Tools

## Tubing Cutters

**I30-2**  
Steel Pipe Cutter



For cutting steel pipes, steel body

CODE NO	∅ mm	mm	
I30-2	10 - 60	380	1

**I32-2**  
Tubing Cutter



For cutting copper and light alloy pipes, light alloy body

CODE NO	∅ mm	mm	
I32-2	3 - 30	150	12

**I30-2R**  
Spare Blade (for I30-2)



CODE NO	∅ mm	
I30-2R	32	1

**I34**  
Telescopic Tubing Cutter



For cutting copper and light alloy pipes, light alloy body, deburrer included

CODE NO	∅ mm	mm	
I34	6-35	150	4

**I38-2**  
Mini Tubing Cutter



For cutting copper and light alloy pipes, light alloy body

CODE NO	∅ mm	mm	
I38-2	3 - 16	50	50

**I32-2R**  
Spare Blade (for I32-2 and I38-2) - 2 Pieces



The code represents a 2 piece package

CODE NO	∅ mm	
I32-2R	18.5	1 pack

**I50**  
Flaring Tool

**new**



For forming 45° conical flared ends on copper and light alloy pipes

CODE NO	CAPACITY (∅ mm)	
I50	4-16	1

**I34-2R**  
Spare Blade (for I34) - 2 Pieces



The code represents a 2 piece package

CODE NO	∅ mm	
I34-2R	18.5	1 pack

10

**CETA FORM**<sup>®</sup>

Cutting Tools and Files



# 10 Cutting Tools and Files

## Ceta Form Aviation Snips Redesigned for maximum performance

Forged in Germany

**new**  
design

- High carbon special tool steel
- Easy cutting with minimum effort thanks to the well-designed compound leverage mechanism
- Cutting edges with micro serration for slip-proof working
- Durable self-opening spring
- Ergonomic handles for a comfortable grip



### J04-250L

Aviation Tin Snips (Left Cut)

**new**  
design



Cuts up to 1.2 mm cold rolled steel / 0.9 mm stainless steel, high-leverage design: effortless cuts

CODE NO	mm	mm	
J04-250L	40	250	6

### J04-250S

Aviation Tin Snips (Straight Cut)

**new**  
design



Cuts up to 1.2 mm cold rolled steel / 0.9 mm stainless steel, high-leverage design: effortless cuts

CODE NO	mm	mm	
J04-250S	40	250	6

### J04-R03

3 Piece Aviation Tin Snips Set

**new**



CODE NO	
J04-R03	1



J04-250R



J04-250S



J04-250L

### J04-250R

Aviation Tin Snips (Right Cut)

**new**  
design



Cuts up to 1.2 mm cold rolled steel / 0.9 mm stainless steel, high-leverage design: effortless cuts

CODE NO	mm	mm	
J04-250R	40	250	6

### J04-300S

Aviation Tin Snips (Long Cut)



Cuts up to 1.2 mm cold rolled steel / 0.9 mm stainless steel, high-leverage design: effortless cuts

CODE NO	mm	mm	
J04-300S	83	300	6

## Metal Snips

### J01 Series Punch Snips

**new**  
design



Cuts up to 1.0 mm cold rolled steel / 0.5 mm stainless steel

CODE NO	mm	DIRECTION	
J01-250L	250	left	6
J01-250R	250	right	6

### J07-250 Berlin Pattern Snips

**new**  
design



Cuts up to 1.0 mm cold rolled steel / 0.5 mm stainless steel

CODE NO	mm	
J07-250	250	6

### J00-SS Spring for J01 / J07 Series



For use on J01 Series and J07-250

CODE NO	
J00-SS	1

### J06-2 Series English Pattern Snips



For long straight cuts on cold rolled steel and stainless steel

CODE NO	mm	mm	
J06-200-2	46	200	6
J06-250-2	57	250	6
J06-300-2	68	300	6

## Jewellers' Snips and Bolt Cutters

### J16-180S Jeweller's Snips (Straight)



For cuts on light weight sheet metals, straight blades

CODE NO	mm	mm	
J16-180S	31	180	6

### J16-180B Jeweller's Snips (Curved)



For cuts on light weight sheet metals, curved blades

CODE NO	mm	mm	
J16-180B	29	180	6

### J10 Series Bolt Cutters



For cutting rods  
Cutting capacities quoted for 80 kgf/mm<sup>2</sup> rods

CODE NO	mm	mm	
J10-450	450	6	1
J10-600	600	8	1
J10-750	750	10	1
J10-900	900	12	1

### J10-R Series Replacement Blades (for J10 Series)



CODE NO		
J10-450R	J10-450	1
J10-600R	J10-600	1
J10-750R	J10-750	1
J10-900R	J10-900	1

## Multi-Purpose Scissors

### J17-190 Multi-Purpose Cutter (Straight)



**StainlessSteel**



For cuts on a diverse range of materials (light metal, fabric, plastic, cardboard etc.)

CODE NO	mm	mm	
J17-190	40	190	6

### J17-190B Multi-Purpose Cutter (Offset)



**StainlessSteel**



For cuts on a diverse range of materials (light metal, fabric, plastic, cardboard etc.)

CODE NO	mm	mm	
J17-190B	40	190	6

### J18 Series Stationary Scissors



**StainlessSteel**



For cuts on a diverse range of materials

CODE NO	mm	mm	
J18-230	84	230	10
J18-250	104	250	10



# 10 Cutting Tools and Files

## Pruning Shears and Hacksaws

### J22-215R

Pruning Shears (Revolving Handle)



SK-5 steel replaceable blade, forged aluminium handles, unique revolving handle design for added comfort

CODE NO	mm	
J22-215R	210	6
J22-215RR	Spare Blade	1

### J22-215P

Pruning Shears (Forged Aluminium Handles)



SK-5 steel replaceable blade

CODE NO	mm	
J22-215P	210	6
J22-215PR	Spare Blade	6

### J30-300

Hacksaw Frame (in-Handle Fixing System)

DIN 6473



For 12" - 300 mm blades, rapid in-handle blade fixing system

CODE NO	mm	
J30-300	430	10

### J32-300

Hacksaw Frame

DIN 6473



For 12" - 300 mm blades

CODE NO	mm	
J32-300	425	10

### J22-215C

Pruning Shears (Cast Aluminium Body)

new



SK-5 steel replaceable blade

CODE NO	mm	
J22-215C	215	6

### J22A-200

Anvil Pruner

new



Allows cut against a fixed base plate (anvil): no cutting impact and better force transmission, SK-5 steel replaceable blade

CODE NO	mm	
J22A-200	200	6

### J36-150

Mini Hacksaw

DIN 6473



For 6" - 150 mm blades

CODE NO	mm	
J36-150	260	12

### J35.B Series

Hacksaw Blades (HSS Bi-Metal) - 10 Pieces

DIN 6494, ISO 2336-1



Unbreakable



HSS alloy teeth, spring steel back

The code represents a 10 piece package

CODE NO	mm	TPI*	
J35-18B	300	18	10 packs
J35-24B	300	24	10 packs

### J23-190

Trimming Shears



Especially for trimming during harvest

CODE NO	mm	mm	
J23-190	53	190	10

### J36-R

Mini Hacksaw Blades - 10 Pieces



Spring steel body, pinned design, for use with J36-150

The code represents a 10 piece package

CODE NO	mm	TPI*	
J36-R	150	18	10 packs



# Holesaws

## J40 Series

Holesaws (HSS Bi-Metal)

**DuraMAX**



DuraMAX quality, super HSS alloy teeth, 4/6 variable pitch tooth design, spring steel body

CODE NO	Ø mm	Ø"	mm	mm	mm
J40-014	14	9/16	55	6	6
J40-016	16	5/8	55	6	6
J40-017	17	11/16	55	6	6
J40-019	19	3/4	50	6	6
J40-020	20	25/32	50	6	6
J40-021	21	13/16	50	6	6
J40-022	22	7/8	50	6	6
J40-024	24	15/16	50	6	6
J40-025	25	1	50	6	6
J40-027	27	1-1/16	50	6	6
J40-029	29	1-1/8	50	6	6
J40-030	30	1-3/16	50	6	6
J40-032	32	1-1/4	50	6	6
J40-033	33	1-5/16	50	6	6
J40-035	35	1-3/8	50	6	6
J40-037	37	1-7/16	50	6	6
J40-038	38	1-1/2	44	6	6
J40-040	40	1-9/16	44	6	6
J40-041	41	1-5/8	44	6	6
J40-043	43	1-11/16	44	6	6
J40-044	44	1-3/4	44	6	6
J40-046	46	1-13/16	44	6	6
J40-048	48	1-7/8	44	6	6
J40-051	51	2	44	6	6
J40-052	52	2-1/16	44	6	6
J40-054	54	2-1/8	44	6	6
J40-057	57	2-1/4	44	6	6
J40-060	60	2-3/8	44	6	6
J40-064	64	2-1/2	44	6	6
J40-065	65	2-9/16	44	6	6
J40-067	67	2-5/8	44	6	6
J40-068	68	2-11/16	44	6	6
J40-070	70	2-3/4	44	6	6
J40-073	73	2-7/8	44	6	6
J40-076	76	3	44	6	6
J40-079	79	3-1/8	44	6	6
J40-083	83	3-1/4	44	6	6
J40-086	86	3-3/8	44	6	6
J40-089	89	3-1/2	44	6	6
J40-092	92	3-5/8	44	6	6
J40-095	95	3-3/4	44	6	6
J40-098	98	3-7/8	44	6	6
J40-102	102	4	44	6	6
J40-105	105	4-1/8	44	6	6
J40-111	111	4-3/8	44	6	6
J40-114	114	4-1/2	44	6	6
J40-121	121	4-3/4	44	6	6
J40-127	127	5	44	6	6
J40-140	140	5-1/2	44	6	6
J40-152	152	6	44	6	6



## J40-A1

Holesaw Arbor #1 (for J40 Series) - Hexagon Shank



Drive: 11 mm (7/16"), Thread: 1/2" - 20 UN

CODE NO	mm	mm	mm
J40-A1	14- 29	93	10

## J40-A2

Holesaw Arbor #2 (for J40 Series) - Hexagon Shank



Drive: 11 mm (7/16"), Thread: 5/8" - 18 UNF

CODE NO	mm	mm	mm
J40-A2	30-152	116	10

## J40-A3

Holesaw Arbor #3 (for J40 Series) - SDS-Plus Shank



Drive: SDS-Plus, Thread: 1/2" - 20 UNF

CODE NO	mm	mm	mm
J40-A3	14- 29	130	6

## J40-A4

Holesaw Arbor #4 (for J40 Series) - SDS-Plus Shank



Drive: SDS-Plus, Thread: 5/8" - 18 UNF

CODE NO	mm	mm	mm
J40-A4	30-152	153	6

## J40-PD Series

Spare HSS Pilot Drills (for Holesaw Arbors)



CODE NO	mm	mm
J40-PD1	for A1 and A3	6 •
J40-PD2	for A2 and A4	6 •

## J40-P13

13 Piece Holesaw Set

**DuraMAX**



CODE NO	mm
J40-P13	1



J40 20, 22, 25, 32, 35, 40, 44, 51, 60, 64 mm

J40-A1 1/2"-20 UNF

J40-A2 5/8"-18 UNF

L 4 mm

# Ceta Form Hole Cutting Saws

- Thanks to HSS teeth, spring steel body, 4/6 variable pitch tooth design, provides a clean, vibration free cut on tough surfaces and materials.
- Special tooth design with side slots and holes for chip removal.
- Suitable for drills and drill saw machines

**DuraMAX**



# 10 Cutting Tools and Files

## RECIPROCATING SAW BLADES

### J40R-ME150

Reciprocating Saw Blade (for Metal) - 5 Pieces



For thin sheet steel, pipes and shapes, 18 TPI teeth, bimetal body  
The code represents a package with indicated quantity

CODE NO	Ref.	mm	Blades Per Pack
J40R-ME150	S922EF	150	5

### J40R-MB150

Reciprocating Saw Blade (for Metal) - 5 Pieces



For thick sheet steel, pipes and shapes, 14 TPI teeth, bimetal body  
The code represents a package with indicated quantity

CODE NO	Ref.	mm	Blades Per Pack
J40R-MB150	S922BF	150	5

### J40R-MB225

Reciprocating Saw Blade (for Metal)



For thick sheet steel, pipes and shapes, 14 TPI teeth, bimetal body  
The code represents a package with indicated quantity

CODE NO	Ref.	mm	Blades Per Pack
J40R-MB225	S1122BF	225	5
J40R-MB225B	S1122BF	225	100

### J40R-DH225

Reciprocating Saw Blade (for Wood & Metal)



For studded wood, sheet steel, pipes and aluminium shapes, 10 TPI teeth, bimetal body  
The code represents a package with indicated quantity

CODE NO	Ref.	mm	Blades Per Pack
J40R-DH225	S1122HF	225	5
J40R-DH225B	S1122HF	225	100

### J40R-PV210F

Reciprocating Saw Blade (For Pallet Repair)



For repairing pallets, 10/14 TPI teeth, bimetal body  
The code represents a package with indicated quantity

CODE NO	Ref.	mm	Blades Per Pack
J40R-PV210F	S722VFR	210	5
J40R-PV210FB	S722VFR	210	100

### J40R-WL240

Reciprocating Saw Blade (for Wood) - 5 Pieces



For hard wood, knotless wood, tree pruning, 4/5 TPI teeth, HCS body  
The code represents a package with indicated quantity

CODE NO	Ref.	mm	Blades Per Pack
J40R-WL240	S1531L	240	5

## JIGSAW BLADES

### J40J-WB100

Jigsaw Blade (for Wood-Basic) - 5 Pieces



8 TPI for cutting hard and soft woods, plywood and plastics, medium-rough cuts, HCS, T shank  
The code represents a 5 piece package

CODE NO	Ref.	mm	50 packs
J40J-WB100	T111C	100	50 packs

### J40J-WF100

Jigsaw Blade (for Wood-Fast Cutting) - 5 Pieces



6 TPI for cutting hard and soft woods, plywood and plastics, straight and very fast cuts, HCS, T shank  
The code represents a 5 piece package

CODE NO	Ref.	mm	50 packs
J40J-WF100	T144D	100	50 packs

### J40J-WF100C

Jigsaw Blade (for Wood-Fast/Curved Cutting) - 5 Pieces



6 TPI for cutting hard and soft woods, plywood and plastics, fast coarse, curved cuts, HCS, T shank  
The code represents a 5 piece package

CODE NO	Ref.	mm	50 packs
J40J-WF100C	T244D	100	50 packs

### J40J-WC100

Jigsaw Blade (for Wood-Clean Cutting) - 5 Pieces



5-6 TPI for cutting hard and soft woods, plywood and plastics, fine clean cuts, HCS, T shank  
The code represents a 5 piece package

CODE NO	Ref.	mm	50 packs
J40J-WC100	T101D	100	50 packs

### J40J-MB075

Jigsaw Blade (for Metal-Basic) - 5 Pieces

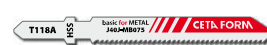

24 TPI for cutting metals up to 3 mm thickness, straight cuts, HSS, T shank  
The code represents a 5 piece package

CODE NO	Ref.	mm	50 packs
J40J-MB075	T118A	75	50 packs

### J40J-A100

Jigsaw Blade (for Aluminium) - 5 Pieces



8 TPI for cutting aluminium/non-ferrous metals and plastics, straight cuts, HSS, T shank  
The code represents a 5 piece package

CODE NO	Ref.	mm	50 packs
J40J-A100	T127D	100	50 packs

# Ceta Form Snap-Off Knives

Excellent ergonomic, unmatched performance



4 types

- Stainless steel blade housing
- Auto-lock mechanism
- Highly ergonomic design
- SK3 quality blades

**J45CP**  
Snap-Off Knife - 18 mm



Stainless steel blade housing, auto-lock mechanism, ships with 2xJ45-R blades

CODE NO	mm	mm	
J45CP	165	18	24
	For display carded delivery = Item code + X 12		

**J45CPM**  
Snap-Off Knife (Metal Body)- 18 mm



Stainless steel blade housing, auto-lock mechanism, ships with 2xJ45-R blades

CODE NO	mm	mm	
J45CPM	155	18	24
	For display carded delivery = Item code + X 12		

**J45CPM/D**  
Snap-Off Knife (Metal Body - Dial Blade Lock)- 18 mm



Stainless steel blade housing, auto-lock mechanism, ships with 2xJ45-R blades

CODE NO	mm	mm	
J45CPM/D	155	18	24
	For display carded delivery = Item code + X 12		

**J45C**  
Compact Snap-Off Knife - 18 mm



Stainless steel blade housing, auto-lock mechanism, ships with 2xJ45-R blades

CODE NO	mm	mm	
J45C	163	18	24

**J45CM**  
Compact Snap-Off Knife (Space Grey) - 18 mm



Stainless steel blade housing, auto-lock mechanism, ships with 2xJ45-R blades

CODE NO	mm	mm	
J45CM	163	18	24

Our snap-off knife range is 100% Ceta Form designed and manufactured



# 10 Cutting Tools and Files

## Snap-Off Knives / Trimming Knives / Blades

### J46CPM

Snap-Off Knife (Metal Body) - 9 mm



Stainless steel blade housing, auto-lock mechanism, ships with 1xJ45-R blades

CODE NO	mm	mm	
J46CPM	140	9	24

### J46SL

Slim9 Steel Body Snap-Off Knife - 9 mm



Slim design, stainless steel body, auto-lock mechanism, ships with 1xJ45-R blades

CODE NO	mm	mm	
J46SL	105	9	24

### J45-RDM

18 mm Snap-Off Knife Blade - 10 Pieces

**DuraMAX**



DuraMAX quality, SK2 steel, sharper and more durable, 7 segments  
The code represents a 10 piece package

CODE NO	mm	mm	
J45-RDM	108	18	10 packs •

### J47-R

Trapezoid Trimming Knife Blade - 10 Pieces



High carbon steel

The code represents a 10 piece package

CODE NO	mm	mm	
J47-R	60	19	10 packs •

### J47TK-S

Safety Trimming Knife (Trapezoid Blade)



Auto-retracting safety system, zinc alloy body, ships with 1xJ47-R spare blade

CODE NO	mm	mm	
J47TK-S	175	19	10

### J47TK

Trimming Knife (Trapezoid Blade)



Zinc alloy body, ships with 1xJ47-R spare blade

CODE NO	mm	mm	
J47TK	175	19	10

### J45-R

18 mm Snap-Off Knife Blade - 10 Pieces



High carbon SK3 steel, 7 segments  
The code represents a 10 piece package

CODE NO	mm	mm	
J45-R	108	18	10 packs •

### J47-RH

Hooked Trimming Knife Blade - 10 Pieces



High carbon steel

The code represents a 10 piece package

CODE NO	mm	mm	
J47-RH	60	19	10 packs •

### J47SPQ

Foldable Trimming Knife (Trapezoid Blade)



Rapid blade change mechanism, aluminium body, foldable design, thumb cushion

CODE NO	mm	mm	
J47SPQ	158	19	12

### J44-067

Wallboard Saw



For cutting plasterboard, chipboard or hardboard, high carbon steel body, 7 TPI

CODE NO	mm/inch	mm	
J44-067	160-6"	300	6

### J46-R

9 mm Snap-Off Knife Blade - 10 Pieces



High carbon SK3 steel, 12 segments  
The code represents a 10 piece package

CODE NO	mm	mm	
J46-R	85	9	10 packs •

# Ceta Form Files



**E** Engineer's Files – for stock removal and surface finish requirements on machined components.

**S** Saw Files – for sharpening wood working saws and similar thin edges.

**R** Rasps – used on wood, leather and similar soft materials for rapid stock removal.

**Double cut:**  
Mainly for steel and other materials.

**Single cut:**  
For a good surface finish, sharpening saws, lathe filing and fitters requirements.

**Rasp cut:**  
For soft materials and wood.  
Produces a rough surface.

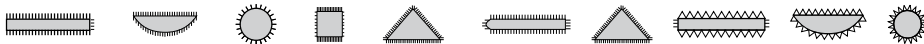

## J55 Series Flat Files



**Double-cut surfaces**

CODE NO	mm "	mm	
<b>Bastard</b>			
J55-106	150 – 6"	16	12 •
J55-108	200 – 8"	20	12 •
J55-110	250 – 10"	25	12 •
J55-112	300 – 12"	30	6 •
<b>Second</b>			
J55-206	150 – 6"	16	12 •
J55-208	200 – 8"	20	12 •
J55-210	250 – 10"	25	12 •
J55-212	300 – 12"	30	6 •
<b>Smooth</b>			
J55-306	150 – 6"	16	12 •
J55-308	200 – 8"	20	12 •
J55-310	250 – 10"	25	12 •
J55-312	300 – 12"	30	6 •

## J55-H Series Flat Files (Softgrip Handle)



**Same specs as J55 series, with softgrip handle**

CODE NO	mm "	mm	
<b>Bastard</b>			
J55-106H	150 – 6"	16	6
J55-108H	200 – 8"	20	6
J55-110H	250 – 10"	25	6
J55-112H	300 – 12"	30	6
<b>Second</b>			
J55-206H	150 – 6"	16	6
J55-208H	200 – 8"	20	6
J55-210H	250 – 10"	25	6
J55-212H	300 – 12"	30	6
<b>Smooth</b>			
J55-306H	150 – 6"	16	6
J55-308H	200 – 8"	20	6
J55-310H	250 – 10"	25	6
J55-312H	300 – 12"	30	6

## J55F Series Tapered Flat Files



**Double-cut surfaces**

CODE NO	mm "	mm	
<b>Second</b>			
J55F-206	150 – 6"	16	12 •
J55F-208	200 – 8"	20	12 •
J55F-210	250 – 10"	25	12 •
J55F-212	300 – 12"	30	6 •

## J55F-H Series Tapered Flat Files (Softgrip Handle)



**Same specs as J55F series, with softgrip handle**

CODE NO	mm "	mm	
<b>Second</b>			
J55F-206H	150 – 6"	16	6
J55F-208H	200 – 8"	20	6
J55F-210H	250 – 10"	25	6
J55F-212H	300 – 12"	30	6

## J55W-206 Warding File

**new**



**Double-cut surfaces**

CODE NO	mm "	mm	
<b>Second</b>			
J55W-206	150 – 6"	15	12 •

## J55W-206H Warding File (Softgrip Handle)

**new**



**Double-cut surfaces**

CODE NO	mm "	mm	
<b>Second</b>			
J55W-206H	150 – 6"	15	6

# 10 Cutting Tools and Files

## Engineer's Files

### J56 Series Half-Round Files



Double-cut surfaces, edges and surfaces tapered to the tip

CODE NO	mm "	mm	
<b>Bastard</b>			
J56-106	150 – 6"	16	12 •
J56-108	200 – 8"	20	12 •
J56-110	250 – 10"	24.5	12 •
J56-112	300 – 12"	29.5	6 •
<b>Second</b>			
J56-206	150 – 6"	16	12 •
J56-208	200 – 8"	20	12 •
J56-210	250 – 10"	24.5	12 •
J56-212	300 – 12"	29.5	6 •
<b>Smooth</b>			
J56-306	150 – 6"	16	12 •
J56-308	200 – 8"	20	12 •
J56-310	250 – 10"	24.5	12 •
J56-312	300 – 12"	29.5	6 •

### J56-H Series Half-Round Files (Softgrip Handle)



Same specs as J56 series, with softgrip handle

CODE NO	mm "	mm	
<b>Bastard</b>			
J56-106H	150 – 6"	16	6
J56-108H	200 – 8"	20	6
J56-110H	250 – 10"	24.5	6
J56-112H	300 – 12"	29.5	6
<b>Second</b>			
J56-206H	150 – 6"	16	6
J56-208H	200 – 8"	20	6
J56-210H	250 – 10"	24.5	6
J56-212H	300 – 12"	29.5	6
<b>Smooth</b>			
J56-306H	150 – 6"	16	6
J56-308H	200 – 8"	20	6
J56-310H	250 – 10"	24.5	6
J56-312H	300 – 12"	29.5	6

### J57 Series Round Files



Double-cut surfaces, tapered to the tip

CODE NO	mm "	mm	
<b>Bastard</b>			
J57-106	150 – 6"	6	12 •
J57-108	200 – 8"	7.5	12 •
J57-110	250 – 10"	9.5	12 •
J57-112	300 – 12"	12	6 •
<b>Second</b>			
J57-206	150 – 6"	6	12 •
J57-208	200 – 8"	7.5	12 •
J57-210	250 – 10"	9.5	12 •
J57-212	300 – 12"	12	6 •

### J57-H Series Round Files (Softgrip Handle)



Same specs as J57 series, with softgrip handle

CODE NO	mm "	mm	
<b>Bastard</b>			
J57-106H	150 – 6"	6	6
J57-108H	200 – 8"	7.5	6
J57-110H	250 – 10"	9.5	6
J57-112H	300 – 12"	12	6
<b>Second</b>			
J57-206H	150 – 6"	6	6
J57-208H	200 – 8"	7.5	6
J57-210H	250 – 10"	9.5	6
J57-212H	300 – 12"	12	6

### J58 Series Square Files



Double-cut surfaces, tapered to the tip

CODE NO	mm "	mm	
<b>Bastard</b>			
J58-106	150 – 6"	6	12 •
J58-108	200 – 8"	8	12 •
J58-110	250 – 10"	9.5	12 •
J58-112	300 – 12"	12	6 •
<b>Second</b>			
J58-206	150 – 6"	6	12 •
J58-208	200 – 8"	8	12 •
J58-210	250 – 10"	9.5	12 •
J58-212	300 – 12"	12	6 •

### J58-H Series Square Files (Softgrip Handle)



Same specs as J58 series, with softgrip handle

CODE NO	mm "	mm	
<b>Bastard</b>			
J58-106H	150 – 6"	6	6
J58-108H	200 – 8"	8	6
J58-110H	250 – 10"	9.5	6
J58-112H	300 – 12"	12	6
<b>Second</b>			
J58-206H	150 – 6"	6	6
J58-208H	200 – 8"	8	6
J58-210H	250 – 10"	9.5	6
J58-212H	300 – 12"	12	6



## Three Square Files

### J59 Series Three Square Files



Double-cut surfaces, tapered to the tip

CODE NO	mm "	mm "	
<b>Bastard</b>			
J59-106	150 – 6"	11	12 •
J59-108	200 – 8"	15	12 •
J59-110	250 – 10"	17.5	12 •
J59-112	300 – 12"	20	6 •
<b>Second</b>			
J59-206	150 – 6"	11	12 •
J59-208	200 – 8"	15	12 •
J59-210	250 – 10"	17.5	12 •
J59-212	300 – 12"	20	6 •

### J59-H Series Three Square Files (Softgrip Handle)



Same specs as J59 series, with softgrip handle

CODE NO	mm "	mm "	
<b>Bastard</b>			
J59-106H	150 – 6"	11	6
J59-108H	200 – 8"	15	6
J59-110H	250 – 10"	17.5	6
J59-112H	300 – 12"	20	6
<b>Second</b>			
J59-206H	150 – 6"	11	6
J59-208H	200 – 8"	15	6
J59-210H	250 – 10"	17.5	6
J59-212H	300 – 12"	20	6

## Saw Files

### J64 Series Milled Files



Single-cut surfaces, one round edge

CODE NO	mm "	mm "	
<b>Second</b>			
J64-206	150 – 6"	16	12 •
J64-208	200 – 8"	20	12 •
J64-210	250 – 10"	25	12 •
J64-212	300 – 12"	30	6 •

### J64-H Series Milled Files (Softgrip Handle)



Same specs as J64 series, with softgrip handle

CODE NO	mm "	mm "	
<b>Second</b>			
J64-206H	150 – 6"	16	6
J64-208H	200 – 8"	20	6
J64-210H	250 – 10"	25	6
J64-212H	300 – 12"	30	6

### J65 Series Taper Saw Files



Single-cut surfaces, tapered to the tip

CODE NO	mm "	mm "	
<b>Bastard</b>			
J65-106	150 – 6"	12	12 •
J65-107	175 – 7"	14	12 •
J65-108	200 – 8"	16	12 •
<b>Second</b>			
J65-204	100 – 4"	6	12 •
J65-245	112 – 4-1/2"	7	12 •
J65-205	125 – 5"	7	12 •
J65-206	150 – 6"	9	12 •

### J65-H Series Taper Saw Files (Softgrip Handle)



Same specs as J65 series, with softgrip handle

CODE NO	mm "	mm "	
<b>Bastard</b>			
J65-106H	150 – 6"	12	6
J65-107H	175 – 7"	14	6
J65-108H	200 – 8"	16	6

### J65D-207 Double Ended Saw File



Single-cut surfaces

CODE NO	mm "	mm "	
<b>Second</b>			
J65D-207	175 – 7"	6	12 •

### J66 Series Round Chainsaw Files



Single-cut surfaces

CODE NO		mm "	
<b>Second</b>			
J66-640	5/32	4	150 – 6" 12 •
J66-848	3/16	4.8	200 – 8" 12 •
J66-855	7/32	5.5	200 – 8" 12 •

WHICH HANDLE FOR WHICH FILE ?			6"	7"	8"	10"	12"
<b>Engineer's Files</b>							
		J55, J55F, J55W Files	J71-03	–	J71-05	J71-05	J71-05
		J56 Half-Round File	J71-03	–	J71-05	J71-05	J71-05
		J57 Round File	J71-04	–	J71-04	J71-06	J71-06
		J58 Square File	J71-04	–	J71-04	J71-06	J71-06
		J59 Three Square File	J71-04	–	J71-04	J71-06	J71-06
<b>Saw Files</b>							
		J64 Milled File	J71-03	–	J71-05	J71-05	J71-05
		J65 Taper Saw File	J71-06	J71-06	J71-06	–	–
<b>Rasps</b>							
		J67 Cabinet Rasp	–	–	J71-05	J71-05	–
		J68 Half-Round Rasp	–	–	J71-05	J71-05	J71-05
		J70 Round Rasp	–	–	J71-04	J71-06	J71-06

# 10 Cutting Tools and Files

## Rasps and File Sets

### J67 Series

Cabinet Rasps



Rasp-cut surfaces

CODE NO	mm "	mm	
<b>Bastard</b>			
J67-108	200 – 8"	20	12 •
J67-110	250 – 10"	25	12 •

### J67-H Series

Cabinet Rasps (Softgrip Handle)



Same specs as J67 series, with softgrip handle

CODE NO	mm "	mm	
<b>Bastard</b>			
J67-108H	200 – 8"	20	6
J67-110H	250 – 10"	25	6

### J72-A Series

5 Piece File Sets (Combination A)



CODE NO	
J72-0851A	1
<b>200 mm</b>	
J55-108H, J55-208H, J56-108H, J57-108H, J58-108H	
J72-1051A	1
<b>250 mm</b>	
J55-110H, J55-210H, J56-110H, J57-110H, J58-110H	

### J68 Series

Half Round Rasps



Rasp-cut surfaces, tapered to the tip

CODE NO	mm "	mm	
<b>Bastard</b>			
J68-108	200 – 8"	20	12 •
J68-110	250 – 10"	24	12 •
J68-112	300 – 12"	29	6 •

### J68-H Series

Half Round Rasps (Softgrip Handle)



Same specs as J68 series, with softgrip handle

CODE NO	mm "	mm	
<b>Bastard</b>			
J68-108H	200 – 8"	20	6
J68-110H	250 – 10"	24	6
J68-112H	300 – 12"	29	6

### J72-B Series

5 Piece File Sets (Combination B)



CODE NO	
J72-0851B	1
<b>200 mm - Bastard Cut</b>	
J55-108H, J56-108H, J57-108H, J58-108H, J59-108H	
J72-0852B	1
<b>200 mm - Second Cut</b>	
J55-208H, J56-208H, J57-208H, J58-208H, J59-208H	

### J70 Series

Round Rasps



Rasp-cut surfaces, tapered to the tip

CODE NO	mm "	mm	
<b>Bastard</b>			
J70-108	200 – 8"	8	12 •
J70-110	250 – 10"	10	12 •
J70-112	300 – 12"	12	6 •

### J70-H Series

Round Rasps (Softgrip Handle)



Same specs as J70 series, with softgrip handle

CODE NO	mm "	mm	
<b>Bastard</b>			
J70-108H	200 – 8"	8	6
J70-110H	250 – 10"	10	6
J70-112H	300 – 10"	12	6

### J71 Series

Softgrip File Handles



For use with standard and saw files

CODE NO	mm	
J71-03	95	12
J71-04	95	12
J71-05	103	12
J71-06	103	12

# Needle Files

## J75-H26

Flat Needle File



CODE NO	mm	mm	
J75-H26	160 - 6"	7.5	12 •

## J75-F26

Tapered Flat Needle File (Warding File)



CODE NO	mm	mm	
J75-F26	160 - 6"	7.5	12 •

## J75-HR26

Half Round Needle File



CODE NO	mm	mm	
J75-HR26	160 - 6"	6.9	12 •

## J75-R26

Round Needle File



CODE NO	mm	mm	
J75-R26	160 - 6"	4	12 •

## J75-R06

6 Piece Needle File Set



CODE NO	
J75-R06	10
6 PC: J75-F26, J75-H26, J75-HR26, J75-R26, J75-S26, J75-TS26	

## J75-S26

Square Needle File



CODE NO	mm	mm	
J75-S26	160 - 6"	3.5	12 •

## J75-TS26

Three Square Needle File



CODE NO	mm	mm	
J75-TS26	160 - 6"	5	12 •

## J75-K26

Knife Needle File



CODE NO	mm	mm	
J75-K26	160 - 6"	7.2	12 •

## J75-R12

12 Piece Needle File Set



CODE NO	
J75-R12	10
12 PC: J75-F26x2, J75-H26x2, J75-HR26, J75-R26, J75-S26, J75-TS26, J75-K26, J75-B26, J75-C26, J75-O26	

## J75-B26

Barrette Needle File



CODE NO	mm	mm	
J75-B26	160 - 6"	7	12 •

## J75-C26

Crossing Needle File



CODE NO	mm	mm	
J75-C26	160 - 6"	6.6	12 •

## J75-O26

Oval Needle File



CODE NO	mm	mm	
J75-O26	160 - 6"	4.6	12 •

## J76-R06

6 Piece Diamond Needle File Set



CODE NO	
J76-R06	10

# 10 Cutting Tools and Files

## Scrapers

### J80-200

Flat Scraper

DIN 8350 Form A



Straight sharp tip, enamelled, special tool steel, wooden handle

CODE NO		 mm	
J80-200	20	200	10



### J81-200

Triangular Scraper

DIN 8350 Form B



Pointed tip, enamelled, special tool steel, wooden handle



CODE NO		 mm	
J81-200	10	200	10

### J82 Series

Triangular Hollow Scrapers



Pointed tip, enamelled, special tool steel, wooden handle



CODE NO		 mm	
J82-150	14	150	10
J82-200	16	200	10

### J83-200

Triangular Spoon Scraper



Pointed tip, enamelled, special tool steel, wooden handle

CODE NO		 mm	
J83-200	14	200	6

# 11



## Hammers and Chisels



# 11 Hammers and Chisels

## Engineer's Hammers and Special Hammers

### Ceta Form Machinist's Hammers

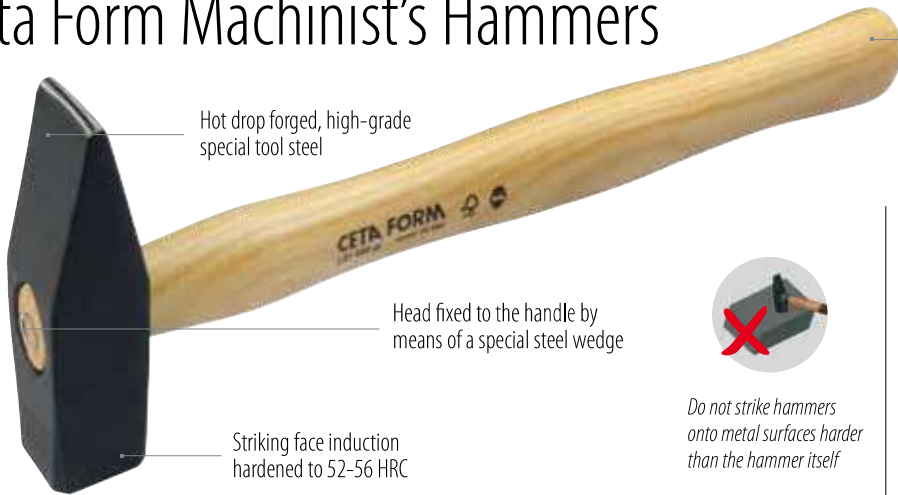

Hot drop forged, high-grade special tool steel

Double ovened ergonomic contoured ashwood handle

Head fixed to the handle by means of a special steel wedge



Do not strike hammers onto metal surfaces harder than the hammer itself

Striking face induction hardened to 52-56 HRC

#### L01 Series Machinist's Hammers

DIN 1041, ISO 15601, TS 5-1



CODE NO	gr	mm	
L01-100	100	265	6
L01-200	200	280	6
L01-300	300	300	6
L01-500	500	320	6
L01-1000	1000	360	6
L01-1500	1500	380	4
L01-2000	2000	400	4

Spare Handles (for L01 Series)



CODE NO	gr	mm	
L01-H100	100	265	12
L01-H200	200	280	12
L01-H300	300	300	12
L01-H500	500	320	12
L01-H1000	1000	360	12
L01-H1500	1500	380	6
L01-H2000	2000	400	6

#### L02 Series Ball Pein Hammers

ISO 15601, TS 5-2



Handle protector

CODE NO	oz	gr	mm	
L02-08	8	227	300	6
L02-12	12	340	325	6
L02-16	16	450	350	6
L02-24	24	700	375	6
L02-32	32	910	400	6

#### L07-450 Claw Hammer (Solid One Piece Forged)



Single piece forged, polished finish (electrofilmed)

CODE NO	Oz-g	mm	
L07-450	16-450	340	6

#### L12DB Series Dead Blow Hammers

new



Metal balls inside the head providing recoilless work

CODE NO	mm	lb	mm	
L12DB-35	35	1.0	290	10
L12DB-45	45	1.5	305	10
L12DB-50	50	2.0	325	8

#### L16 Series Rubber Mallets DIN 5128, TS 5-27



Hard rubber head

CODE NO	mm	mm	
L16-30	55	300	6
L16-40	60	310	6
L16-50	65	315	6

#### L12 Series Soft Face Hammers



Interchangeable plastic heads, casted body (powder coated finish)

CODE NO	mm	mm	
L12-30	30	280	6
L12-40	40	300	6
L12-50	50	340	6



Spare Plastic Heads (for L12 Series) - Single

CODE NO	mm	M	
L12-R30	30	M12	6•
L12-R40	40	M16	6•
L12-R50S	50	M20	6•

#### L17-40 Aluminium Hammer



CODE NO	mm	mm	
L17-40	40	300	6

#### L18 Series Copper Hammers



CODE NO	gr	mm	
L18-750	750	320	6
L18-1000	1000	350	6
L18-1500	1500	360	6

# Punches and Chisels

## L25-2 Series

### Flat Chisels

DIN 6453, TS 492-1



For heavy duty cutting and shaping, 60° regrindable tip

CODE NO	mm	mm	
L25-150-2	150	18	12
L25-200-2	200	24	12
L25-250-2	250	28	6
L25-300-2	300	30	6

## L25-G-2 Series

### Flat Chisel (with Plastic Guard)

DIN 6453, TS 492-1



Structural specs same as L25-2 series, with plastic hand guard

CODE NO	mm	mm	
L25-250G-2	250	28	6
L25-300G-2	300	30	6

Spare plastic guard (for L25-G-2 Series)



CODE NO	mm	
L25G-250-2	117	6•
L25G-300-2	117	6•

## L27 Series

### Cold Flat Chisels

DIN 6453, TS 492-1



For cutting, shaping and removing cold metals

CODE NO	mm	mm	
L27-125	125	12	12
L27-150	150	16	12
L27-175	175	20	12

## L28 Series

### Cross Cut Chisels

DIN 6453, TS 492-2



For cutting or grooving keyways or slots

CODE NO	mm	mm	
L28-125	125	5	12
L28-150	150	7	12

## L29 Series

### Centre Punches

DIN 7252, TS 2338-3



For piercing or marking on metal for starting drills

CODE NO	mm	mm	
L29-3	3	100	12
L29-4	4	120	12
L29-5	5	150	12

## L29AT

### Automatic Center Punch

DIN 7252, TS 2338-2



Single handed use, adjustable impact power, non-slip knurled body, replaceable tip (L29ATR)

CODE NO	mm	mm	
L29AT	3	150	20
L29ATR	Spare Tip (for L29AT)		25

## L30 Series

### Taper Pin Punches

DIN 6458, TS 2338-2



For loosening frozen or tight pins and keys

CODE NO	mm	mm	
L30-2	2	120	12
L30-3	3	120	12
L30-4	4	120	12
L30-5	5	120	12
L30-6	6	120	12

## L31 Series

### Parallel Pin Punches

DIN 6450, TS 2338-1



For driving out and removing already loosened pins

CODE NO	mm	mm	
L31-2	2	150	12
L31-3	3	150	12
L31-4	4	150	12
L31-5	5	150	12
L31-6	6	150	12
L31-8	8	150	12
L31-10	10	150	12

## L35-61

### 6 Piece Chisel and Punch Set



CODE NO	
L35-61	10

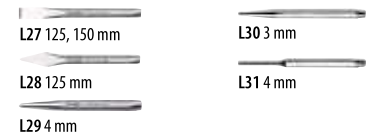

## L35-62

### 6 Piece Parallel Pin Punch Set



CODE NO	
L35-62	10

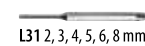

## L20-120

### Crow Bar with Open and Pointed Ends



One end with straight tip, other end pointed tip, special tool steel

CODE NO	cm	mm	
L20-120	120	30	1

# 11 Hammers and Chisels

## Punch and Chisel Sets

### L35A-11

5 Piece Chisel and Punch Set (ANSI Spec.)

**new**



CODE NO	
L35A-11	1

- L27A 5/8 x 6-3/4 inch
- L29A 1/8 x 4-7/8 inch
- L30A 1/8 x 5-1/8 inch
- L31A 2 PC: 1/8 x 5-3/16, 3/16 x 5-7/8 inch

### L35A-11

11 Piece Chisel and Punch Set (ANSI Spec.)

**new**



CODE NO	
L35A-11	1

- L27A 3 PC: 3/8 x 5-1/2, 1/2 x 6, 5/8 x 6-3/4 inch
- L29A 3/16 x 6 inch
- L30A 3 PC: 3/32 x 5-1/4, 5/32 x 6, 3/16 x 6-1/4 inch
- L31A 3 PC: 3/32 x 4-7/32, 5/32 x 5, 3/16 x 5-7/8 inch
- Chisel gauge 2-5/8 inch

### L40-P14

14 Piece Hollow Punch Set

**new**



CODE NO	
L40-P14	1

- L40 14 PC: 5, 6, 8, 10, 11, 13, 16, 19, 22, 25, 28, 32, 35 mm + Driver

## Wood Chisels



### L50-2 Series

Wood Chisels (Softgrip Handle)

DIN 5139, ISO 2729, TS 531



Precision ground cutting edges, polished finish (electrofilmed)

CODE NO	mm 	mm 	
L50-06-2	6	140	10
L50-08-2	8	140	10
L50-10-2	10	140	10
L50-12-2	12	140	10
L50-14-2	14	140	10
L50-16-2	16	140	10
L50-18-2	18	140	10
L50-20-2	20	140	10
L50-22-2	22	140	10
L50-25-2	25	140	10
L50-30-2	30	140	10

### L50-W6-2

6 Piece Softgrip Handle Wood Chisel Set (Wooden Boxed)



CODE NO	
L50-W6-2	1

- 6 PC: 6, 10, 12, 16, 20, 25 mm

### L50-B4-2

4 Piece Softgrip Handle Wood Chisel Set



CODE NO	
L50-B4-2	1

- 4 PC: 6, 12, 20, 25 mm



### L50W Series

Wood Chisels (Exclusive Line)

DIN 5139, ISO 2729, TS 531



Precision ground cutting edges, polished finish (electrofilmed), dark stained beech handle

CODE NO	mm 	mm 	
L50-06W	6	120	10
L50-08W	8	122	10
L50-10W	10	124	10
L50-12W	12	126	10
L50-14W	14	128	10
L50-16W	16	130	10
L50-18W	18	132	10
L50-20W	20	134	10
L50-22W	22	136	10
L50-25W	25	140	10
L50-30W	30	144	10

### L50-W6W

6 Piece Exclusive Line Wood Chisel Set (Wooden Boxed)



CODE NO	
L50-W6W	1

- 6 PC: 6, 10, 12, 16, 20, 25 mm



12



Specialist Automotive Tools



# 12 Specialist Automotive Tools

## Test Kits

### N11-02A

Compression Tester Kit (for Petrol Engines)



CASE WxHxD (mm)  
3 25 x 14 0 x 4 0



For testing the compression of petrol engines, kit contains 150 mm coupling adaptor and 350 mm flexible adaptor (14/18 mm threaded)

CODE NO	CAPACITY psi / kPa	
N11-02A	0-300 / 0-2000	1

### N11-03

Vacuum and Pressure Test / Bleed Kit



CASE WxHxD (mm)  
3 5 0 x 3 1 0 x 9 0

Helps identify a variety of faults including fuel, ignition, transmission, emission and air conditioning/heating, also suitable for bleeding brake and clutch systems

CODE NO	CAPACITY bar	
N11-03	(-1) - 4	1

### N11-05

Diesel Injector Flow Test Kit (Common Rail)



CASE WxHxD (mm)  
3 8 0 x 2 9 0 x 6 0



Measures return fuel flow on diesel vehicles up to 6 cylinders (Common Rail), identifies faulty injectors easily, tubes for quick tests and bottles for longer, more accurate tests

CODE NO	
N11-05	1

### N11-02B-2

Compression Tester Kit (for Diesel Engines)



CASE WxHxD (mm)  
3 8 0 x 2 8 0 x 6 0



Kit for testing the compression of diesel engines, comprehensive range of dummy glow plugs and injectors

CODE NO	CAPACITY bar/psi	
N11-02B-2	70/1000	1

### N11-20

Mechanic's Stethoscope



Used to identify the source of engine noise (i.e.: damaged valves, blown gaskets etc.), plastic ear pieces, supplied with 210 mm extension probe (fixed probe: 80 mm)

CODE NO	
N11-20	1



# Cooling and Fuel System

## N12-01 Cooling System Pressure Test Kit



CASE WxHxD (mm)  
410 x 380 x 90

Complete kit for the detection of leakages in cooling systems of cars, wide model coverage

**Updated content: Now covers more models**

CODE NO	
N12-01	1

## N12-01B Cooling System Pressure Test Kit (Universal Adaptors)



CASE WxHxD (mm)  
400 x 370 x 80

Kit for the detection of leakages in cooling systems of cars, conical adaptors in the kit allow for universal coverage

CODE NO	
N12-01B	1

## N12-04AB Refractometer (Suitable for AdBlue®)

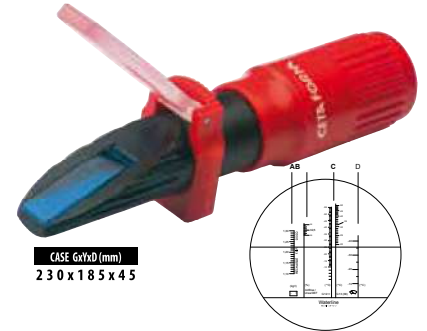



CASE GxVxD (mm)  
230 x 185 x 45

4 in 1 measurement tool:

- \*Antifreeze
- \*Battery Acid
- \*Washer fluid antifreeze
- \*Adblue additive

Can be used on vehicles which use ethylene glycol as coolant or sulphuric acid as battery fluid. Waterline adjustment screw, visual clarity adjustment, pipette for draining fluid.

CODE NO		
N12-04AB	150	1

## N12-05P Antifreeze Tester (with Reservoir)





- 1- Large and easy to read dial
- 2- Hydrostatic liquid lock
- 3- Temperature balancing twin rotor measuring unit
- 4- Intake canal preventing air bubbles

CODE NO	TEMPERATURE RANGE °C	
N12-05P	0/-40	1

## N12-05 Antifreeze Tester



Suitable for measuring ethylene glycol (Antifreeze) density inside radiator, tubular shatterproof composite body

CODE NO		
N12-05	200	1

# 12 Specialist Automotive Tools

## Cooling and Fuel System

### N12-10

Hose Clamp Pliers (for Spring Band Hose Clamps)



For tag-type hose clamps, rotating tips

CODE NO	mm	
N12-10	220	6

### N12-12HD

CV Joint Boot Band Pliers (Heavy Duty)



10  
3/8"

For installing CV joint clamps on axle boots (Hyrel) with preset torque values, used in conjunction with a torque wrench

CODE NO	mm	
N12-12HD	265	1

### N12-1625

Fluid Line Clamp



Used to stop fuel flow temporarily, knob adjustment

CODE NO	mm	
N12-1625	25	1

### N12-10L

Long Reach Hose Clamp Pliers (for Spring Band Hose Clamps)

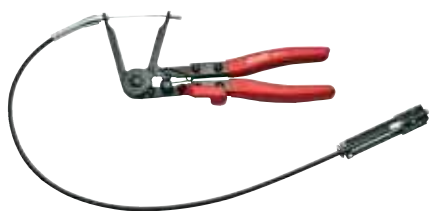

For tag-type hose clamps, 680 mm bowden shaft for restricted areas

CODE NO	mm	
N12-10L	230	12

### N12-13

Hose Clamp Pliers (for CLIC Clamps)



For CLIC and CLIC-R hose clamps

CODE NO	mm	
N12-13	180	6

### N12-25 Series

Fuel Tank Sender Unit Wrenches (2 Arms)



Used on floating rings in fuel tanks, 2 arms

CODE NO	mm	mm	
N12-251	80-120	24	1
N12-252	114-174	24	1

### N12-12

Hose Clamp Pliers (for Ear Hose Clamps)



For ear-type hose clamps (found on vacuum hoses, fuel and cooling systems), also suitable for CV joint clamps

CODE NO	mm	
N12-12	230	12

### N12-P16 Series

Flexible Hose Clamps



Stops flow inside flexible hoses, high quality plastic, includes locking ring

CODE NO	mm	max. mm	
N12-P1615	155	15	12
N12-P1630	185	30	12
N12-P1660	250	60	12

# Ignition System

## C17-R Series

3/8" Drive 6 Point Spark Plug Sockets (Retaining Rubber)

ISO 11168



10  
3/8"



6-Point, retaining rubber

CODE NO	mm	"	mm	
C17-R16	16	5/8	63	12 •
C17-R18	18	-	63	12 •
C17-R21	21	13/16	65	12 •
For display carded delivery = Item code + X				6

## C17-R14C

3/8" Drive 12 Point Spark Plug Socket (Retaining Clip)

ISO 11168



10  
3/8"

For 14 mm spark plugs, with metal clip holder

**Suitable for both 6 and 12 point plugs**

These series come with an integrated metal clip with 5 leaves allowing for maximum grip, also resistant against heat



CODE NO	mm	"	mm	
C17-R14C	14	-	63	6 •
For display carded delivery = Item code + X				6

## C17-R14ML

3/8" Drive 12 Point Spark Plug Socket (Magnetic-Extra Long)

ISO 11168



10  
3/8"



For 14 mm spark plugs, retaining magnet

**Suitable for both 6 and 12 point plugs**

CODE NO	mm	"	mm	
C17-R14ML	14	-	250	6 •
For display carded delivery = Item code + X				6

## C27-R Series

1/2" Drive 6 Point Spark Plug Sockets (Retaining Rubber)

ISO 11168



12.5  
1/2"



6-Point, retaining rubber

CODE NO	mm	"	mm	
C27-R16	16	5/8	67	12 •
C27-R21	21	13/16	67	12 •
For display carded delivery = Item code + X				6

## C27-RM Series

1/2" Drive 6 Point Spark Plug Sockets (Magnetic)

ISO 11168



12.5  
1/2"



6-Point, retaining magnet

CODE NO	mm	"	mm	
C27-R16M	16	5/8	67	6 •
C27-R21M	21	13/16	67	6 •
For display carded delivery = Item code + X				6

## B32-S Series

T-Handle Swivel Spark Plug Socket Wrenches



Swiveling 6-point socket, retaining magnet, with 3/8" drive female end

CODE NO	mm	"	mm	
B32-16S	16	5/8	510	6
B32-21S	21	13/16	510	6

## N13-10R04

4 Piece 3/8" Drive Glow Plug Socket Set



10  
3/8"



Set for installing / removing glow plugs, universal joint sockets, 72 mm socket depth

CODE NO	
N13-10R04	10
4 PC: 8, 9, 10, 12 mm	

## N13-PC14

Spark Plug Pliers (Curved Long Nose)

new



For removal of spark plug boot in deep-seated engine applications

CODE NO	MIN. mm	mm	
N13-PC14	14	290	6

## R28S-P1420

20 Piece M14 C-Coil Thread Repair Kit (Spark Plug Threads)



CASE WxHxD (mm)  
245 x 125 x 40



Kit for the repair of damaged or worn-out spark plug threads, patented placement tang, high quality Chrome Nickel stainless steel female threads, HSS drill tap

CODE NO	
R28S-P1420	1

	M14x1.25
	No. 8 - 3 piece assembly
	2 mm L Key
	R28-SC14/1 M14x1.25 h: 7.7 mm (5 pc)
	R28-SC14/2 M14x1.25 h: 11.0 mm (5 pc)
	R28-SC14/3 M14x1.25 h: 15.0 mm (5 pc)

# 12 Specialist Automotive Tools

## Oil Service

### N14-01 Series

Oil Filter Cap Wrenches

10  
3/8"



Cap type, prevents damage to the filter housing, low profile design for tight spaces, heavy gauge steel

Max. torque 115 Nm (85 lbf. ft)

<b>N14-016514</b>	Japanese Cars
<b>N14-016606</b>	FIAT
<b>N14-017612</b>	FORD, PEUGEOT, RENAULT
<b>N14-017614</b>	BMW, MERCEDES, PORSCHE, VW, AUDI, SEAT
<b>N14-018616</b>	BMW, VOLVO
<b>N14-019515</b>	FORD: Transit van

CODE NO	∅ mm	Flutes	
N14-016514	65	14	12
N14-016606	66	6	12
N14-017612	76	12	12
N14-017614	76	14	12
N14-018616	86	16	12
N14-019515	95	15	12

### N14-01S Series

3/8" Drive Oil Filter Sockets (Low Profile)

10  
3/8"



Low profile design for use on cartridge steel filters

<b>N14-01S27</b>	MERCEDES A-Class, FORD TDCi, NISSAN DCi, Renault
<b>N14-01S32</b>	OPEL Astra-G/Corsa-B/Zafira
<b>N14-01S36</b>	BMW 24V, FORD DuraTorq diesel / Transit, MERCEDES 116 MB Vito Cdi, OPEL 16V

CODE NO	∅ mm	
N14-01S27	27	12
N14-01S32	32	12
N14-01S36	36	12

### N14-027414

1/2" Drive Oil Filter Cap Wrench (Aluminum)

12.5  
1/2"



Cap type, aluminum material for minimum risk of damage to filter housing, low profile design for tight spaces

**N14-027414** AUDI, BMW, MERCEDES, VW

CODE NO	∅ mm	Flutes	
N14-027414	74	14	12

### N14-01K09

9 Piece Oil Filter Cap Wrench Set (Euro Vehicles)



CASE Width (mm)  
330 X 260 X 70

Suitable for most Euro vehicles on the market, 3/8" drive content, supplied with 3/8"-1/2" adaptor

CODE NO	
N14-01K09	1



**N14-01**  
∅ mm 66 (6 Flutes), 76 (12 Flutes),  
76 (14 Flutes), 86 (16 Flutes)



**N14-01S**  
∅ mm 27 (6 Flutes),  
32 (6 Flutes), 36 (6 Flutes)



**N14-027414**  
∅ mm 74 (14 Flutes)



**C21-91S** D1/2" - E3/8"

### N14-03 Series

Oil Filter Wrenches (with Double Chain)



Very high clamping power, swivel head, duplex chain for security

CODE NO	∅ mm	mm	
N14-031	60-110	230	1
N14-032	60-160	230	1
<b>N14-033</b>	<b>60-195</b>	<b>230</b>	<b>1</b>

### N14-03SQ Series

Oil Filter Wrenches (with Thin Double Chain)

**new**



12.5  
1/2"

For operation in restricted areas, very high clamping power, duplex chain for security

CODE NO	∅ mm	
N14-031SQ	60-110	1
N14-032SQ	70-170	1

### N14-04 Series

Oil Filter Band Wrenches



Pin fixed adjustable diameter

CODE NO	∅ mm	mm	
N14-041	60- 80	190	1
N14-042	80-110	190	1

# Oil Service

## N14-05 Series

Oil Filter Strap Wrenches

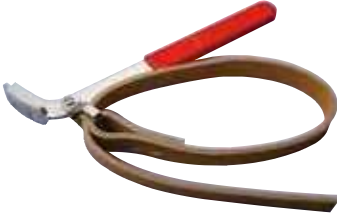

Reinforced rubberised strap

CODE NO	∅ max. mm	mm	
N14-051	160	225	6
N14-052	200	225	6



Spare Strap (for N14-05 Series)

CODE NO		
N14-051R	N14-051	1
N14-052R	N14-052	1

## N14-061S

Oil Filter Band Wrench (Ergo Grip)



High strength non slip metal strap, durable ergonomic handle

CODE NO	∅ mm	mm	
N14-061S	60-100	155	6



Spare Strap (for N14-06 Series)

CODE NO		
N14-06R	N14-061S, N14-06	10 •

## N14-081

Adjustable Oil Filter Pliers

**new**



Slip joint design quickly adjusts to most filter sizes

CODE NO	∅ mm	mm	
N14-081	60-100	300	1

## N14-071

3 Arm Oil Filter Claw Wrench



**10**  
3/8"



Self-adjusting mechanism: higher applied torque for tighter claw grip, 3/8" drive, supplied with 3/8" M-1/2" F adaptor

CODE NO	∅ mm	
N14-071	65-120	1

## N14-072

1/2" Drive 3 Arm Oil Filter Claw Wrench (Commercial Vehicles)



**12.5**  
1/2"



For commercial vehicles, also used on air dryer cartridges, self-adjusting mechanism: higher applied torque for tighter claw grip, 1/2" drive

CODE NO	∅ mm	
N14-072	95-165	1

## N14-10

Oil Drain Plug Wrench



For removal and installation of female oil drain plugs

CODE NO	∅ mm	mm	
N14-10	8x10	285	6

## N14-12S Series

3/8" Drive Square Oil Drain Plug Sockets



For removal and installation of female oil drain plugs

CODE NO	∅ mm	mm	
N14-12S08	8	40	1
N14-12S10	10	40	1
N14-12S12	12	40	1

## N14-12R09

9 Piece 3/8" Drive Oil Drain Plug Socket Set



**10**  
3/8"

CODE NO	
N14-12R09	1
N14-12S 8, 10, 12 mm	
N14-12H 8, 10, 12, 14, 17 mm	
	T-HANDLE 3/8"x165 mm



# 12 Specialist Automotive Tools

## Engine Timing

### N15-T1PE

Crankshaft Pulley Removal Tool  
(for Ribbed Pulleys)



10  
3/8"

For removal of crankshaft and auxiliary pulleys, grooved legs for ribbed pulleys, low profile design for tight spaces

CODE NO			
N15-T1PE	45-175	19	1

### N15-T2UNI

Universal Pulley Wrench



For retaining the camshaft sprockets when replacing the timing belt or during engine maintenance work

CODE NO			
N15-T2UNI	60-220	400	1

### N15-T3UNI

6 Piece Belt Tension Locking Pin Set



For locking the camshaft sprockets when changing the timing belt

CODE NO	
N15-T3UNI	1
<b>6 PC:</b> 0.79mm / .0310", 1.24mm / .0490", 1.37mm / .0540", 1.49mm / .0585", 1.68mm / .0660", 1.92mm / .0760"	

### N15-K1VAG

Timing Tool Kit (VAG 1.2D, 1.4D, 1.6D, 1.9D, 2.0D Tdi PD/CR)



#### Applications:

**Audi:** A1, A3, A4, A5, A6, Q5, TT / **Seat:** Alhambra, Altea, Cordoba, Ibiza, Leon, Toledo / **Skoda:** Fabia, Fabia II, Octavia, Octavia II, Roomster, Superb, Superb II, Yeti / **VW:** Amarok, Beetle, Bora, Caddy, EOS, Fox, Golf, Jetta, Lupo, Passat/CC, Polo, Scirocco, Sharan, Tiguan, Touran, Transporter / **Dodge:** Caliber / **Ford:** Galaxy / **Mitsubishi:** Grandis, Lancer, Outlander

#### Engine Codes:

**VAG Pompe (Pompe Duse):** AJM, AMF, ANU, ARL, ASZ, ATD, AUY, AVB, AVF, AVQ, AWX, AXB, AXC, AXR, AZV, BAY, BDJ, BDK, BEW, BGW, BHC, BHW, BJB, BKC, BKD, BKE, BKP, BLB, BLS, BLT, BMA, BMM, BMN, BMP, BMR, BMS, BMT, BNA, BNM, BNV, BPW, BPX, BPZ, BRB, BRC, BRD, BRE, BRF, BRM, BRR, BRS, BRT, BRU, BSS, BST, BSU, BSV, BSW, BTB, BUK, BUY, BUZ, BVA, BVE, BVF, BVG, BVH, BVK, BWB, BWV, BXE, BXF, BXJ

**VAG (Common Rail):** CAAA, CAAB, CAAC, CAE, CAGA, CAGB, CAGC, CAHA, CAHB, CAYA, CAYB, CAYC, CAYD, CAYE, CBAA, CBAB, CBAC, CBBA, CBBB, CBDA, CBDB, CBDC, CBEA, CCHA, CCHB, CDBA, CDCA, CEGA, CFCA, CFFA, CFFB, CFFG, CFHA, CFHB, CFHC, CFHE, CFHF, CFJA, CFWA, CGLA, CGLB, CJAA, CJCA, CJC, CLCA, CLCB, CLJA, CLNA, CMEA

**Dodge:** ECD

**Ford:** ANU, ASZ, AUY

**Mitsubishi:** BWC, BSY

CODE NO	
N15-K1VAG	1
N15-K1VAG/1	Crankshaft Setting Tool (A)
N15-K1VAG/2	Crankshaft Setting Tool (B)
N15-K1VAG/3	Injection Pump Locking Pins - 1 pair

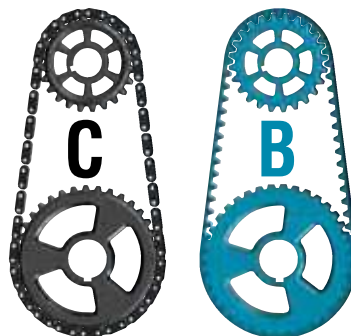

### N15-K2VAG.U

Timing Tool Kit (VW/Audi 1.2/1.4 TFSI - 1.4/1.6 FSI)



#### Applications:

**Audi:** A1, A3 / **Seat:** Altea, Cordoba, Ibiza, Leon, Toledo / **Skoda:** Fabia II, Octavia II, Roomster, Super II, Yeti / **VW:** Caddy, Eos, Golf, Jetta, Passat, Polo, Scirocco, Tiguan, Touran

#### Engine Codes:

AXU, BAG, BKG, BLN, BLF, BLG, BLP, BMY, BTS, BWK, CAVA, CAVB, CAVC, CAVD, CAVE, CAVF, CAXA, CAXC, CBZA, CBZB, CBZC, CDGA, CSMA

CODE NO	
N15-K2VAG.U	1



N15-K2VAG.U/1	Camshaft Alignment Tool
N15-K2VAG.U/2	TDC Position Tool (for use with Dial Gauge)
N15-K2VAG.U/3	Tensioner Locking Pin
N15-K2VAG.U/4	Crankshaft Locking Bolt
N15-K2VAG.U/5	Camshaft Locking Clamp

### N15-K2VAG.12

Timing Tool Kit (VAG 1.2 TSI)

new



#### Applications:

**Audi:** A1, A3 / **Seat:** Altea, Ibiza, Leon, Toledo / **Skoda:** Fabia II, Octavia II, Praktik, Rapid, Roomster, Yeti / **VW:** Beetle, Caddy, Golf Plus, Golf VI, Jetta, Polo, Touran  
Engine Codes: CBZA, CBZB, CBZC

CODE NO	
N15-K2VAG.12	1
N15-K2VAG.U/4	Crankshaft Locking Bolt
N15-K2VAG.U/5	Camshaft Locking Clamp

# Engine Timing

## N15-K3VAG

Timing Tool Kit (VW/Seat/Skoda 1.2 6/12V)



**Applications:**

Seat: Cordoba, Ibiza / Skoda: Fabia, Fabia II, Roomster / VW: Fox, Polo

**Engine Codes:**

AWY, AZQ, BBM, BMD, BME, BXV, BZG, CEVA, CGPA, CGPB, CHFA, CHFB, CJLA

CODE NO



N15-K3VAG

1



- N15-K3VAG/1 Camshaft Locking Clamp - 1 pair
- N15-K3VAG/2 Crankshaft Locking Bolt (A)
- N15-K3VAG/3 Crankshaft Locking Bolt (B)

## N15-K1BMW

Timing Tool Kit (BMW 2.0, 3.0D N47/N57)



**Applications:**

116d, 118d, 120d, 123d, 316d, 318d, 320d, 325d, 330d/xd, 520d, 525d, 530d, 530d GT, 535d, 535d GT, 730d/Ld, 740d, 740d xDrive, X1 sDrive 1.8d/2.0d, X1 xDrive 1.8d/2.0d/2.3d, X3 2.0d, X3 xDrive 1.8d/3.0d, X5 3.0d, X5 xDrive 4.0d, X6 xDrive 3.0d/4.0d

**Engine Codes:**

D20A, D20B, D20U0, D2000, D20T0, D30U0, D3000, D3001, D30T0

CODE NO



N15-K1BMW

1



- N15-K1BMW/1 Camshaft Alignment Tool
- N15-K1BMW/2 Crankshaft Pulley Turning Tool
- N15-K1BMW/3 High Pressure Pump Sprocket Removal Tool
- N15-K1BMW/4 Flywheel Plate Timing Pin
- BT/8008 Socket Adaptor (1/2" - 10 mm)

## N15-K2BMW

Timing Tool Kit (BMW/Mini 1.4, 1.6 N13)



Kit also suitable for Citroen and Peugeot models, please refer to the detailed application and engine codes list

**Applications:**

BMW: 114i, 116i, 118i, 316i, 320i, 520i (TR) / Citroen: C3, C3 Picasso, DS3, C4, DS4, DS5 / Mini: One, Cooper, Cooper S / Peugeot: 207/CC, RC, 208/GTI, 307, 308/GTI, 3008, 408/Sport, 508, RCZ

**Engine Codes:**

BMW: N13  
Mini: N18  
PSA: EP3/EP3C, EP6/EP6C, EP6CDT, EP6CDT MD, EP6CDTM, EP6DT, EP6DTS

CODE NO



N15-K2BMW

1

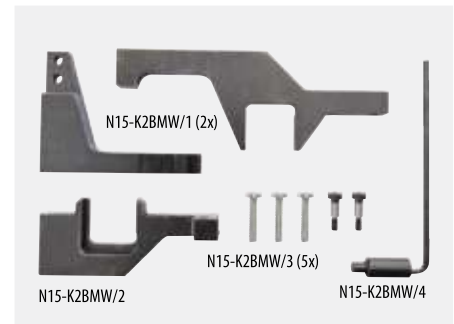

- N15-K2BMW/1 Camshaft Alignment Tool (Inlet) - Supplied in 2 parts
- N15-K2BMW/2 Camshaft Alignment Tool (Exhaust)
- N15-K2BMW/3 Locking Bolts - 5 pieces
- N15-K2BMW/4 Crankshaft Setting Pin

## N15-T1BMW

Injection Pump Puller (BMW 1.8, 2.0, 3.0D)



For the safe removal of the fuel pump when removing the pump sprocket, and to retain the position of the pump sprocket in-sit, whilst the pump is being removed from the engine

**Applications:**

M47, M47T2, M47TU, M57, M57TU engines on BMW 318d, 320d (E46) - 1988 to 2005 / 318td, 320td, 525d, 530d, 530, 535 (E60-61) - 2000 to 2006

CODE NO



N15-T1BMW

1



# 12 Specialist Automotive Tools

## Engine Timing

### N15-K1FIA

Timing Tool Kit (FIAT 1.3 MultiJet/OPEL 1.3 CDTI)



Kit also suitable for Suzuki and Ford models, please refer to the detailed application and engine codes list

#### Applications:

Alfa Romeo: MiTo / Fiat: 500, Albea (TR), Doblo/Cargo, Fiorino, Grande Punto, Idea, Linea, Panda, Puntì, Punto Evo, Qubo / Ford: Ka / Lancia: Musa, Ypsilon / Suzuki: Ignis, Splash, Swift, Wagon R+ / Vauxhall/ Opel: Agila, Agila\* B, Astra-H, Astra-J, Combo-C, Corsa-C, Corsa-D, Meriva-A, Meriva-B, Tigra-B

#### Engine Codes:

Fiat Group: 169A1.000, 188A8.000, 188A9.000, 199A2.000, 199A3.000, 199A9.000, 199B1.000, 199B2.000, 223A9.000  
Suzuki: D13A, Z13DT, Z13DTJ  
Vauxhall/Opel: A13DTC, A13DTE, A13DTR, D13A, LDV/A13DTC, LSF/A13DTE, Y13DT, Y13DTH, Z13DT, Z13DTI, Z13DTH, Z13DTJ, Z13DTR

CODE NO



N15-K1FIA

1



N15-K1FIA/1 Crankshaft Locking Tool

N15-K1FIA/2 Tensioner Locking Tool

N15-K1FIA/3 Flywheel Locking Tool

N15-K1FIA/4 Camshaft Locking Clamp - 1 pair

N15-K1FIA/5 Flywheel Locking Pin

### N15-K2FIA

Timing Tool Kit (FIAT 1.2, 1.4 16V)



#### Applications:

Alfa Romeo: Giulietta, MiTo / Fiat: 500, Albea (TR), Brava/Bravo, Grande Punto, Idea, Linea, Marea/Weekend, Palio Weekend, Panda, Punto, Stilo  
Lancia: Delta, Musa, Ypsilon

#### Engine Codes:

169A3.000, 176B9.000, 182B2.000, 188A5.000, 192B2.000, 198A1.000, 198A4.000, 199A6.000, 199A8.000, 843A1.000

CODE NO



N15-K2FIA

1

### N15-K3FIA

Timing Tool Kit  
(FIAT 1.6D, 1.9D, 2.0D, 2.4D JTD/MultiJet)



#### Applications:

Alfa Romeo: 145, 146, 147, 156, 159, 166, Brera, Crosswagon, Giulietta, GT, MiTo, Spider / Fiat: Brava/Bravo, Cromia, Doblo/Cargo, Grande Punto, Idea, Linea, Marea/Weekend, Multipla, Palio Weekend, Punto, Punto Evo, Sedici, Stilo, Strada Pick-Up / Lancia: Delta, Kappa, Lybra, Musa, Thesis

#### Engine Codes:

182B4.000, 182B9.000, 185A6.000, 186A6.000, 186A8.000, 186A9.000, 188A2.000, 188A7.000, 188B2.000, 192A1.000, 192A3.000, 192A5.000, 192A8.000, 192A9.000, 192B1.000, 192B4.000, 192B5.000, 198A2.000, 198A3.000, 198A6.000, 199A5.000, 223A7.000, 223B1.000, 323.02, 325.01, 342.02, 350A2.000, 350A3.000, 362.02, 371.01, 838A8.000, 839A5.000, 839A6.000, 841C.000, 841G.000, 841H.000, 841M.000, 844A1.000, 844A2.000, 937A2.000, 937A3.000, 937A4.000, 937A5.000, 937A6.000, 939A1.000, 939A2.000, 939A3.000, 939A7.000, 939A8.000, 939A9.000, 940A3.000, 940A4.000, 940A5.000, 955A3.000, 955A4.000, D19AA

CODE NO



N15-K3FIA

1

### N15-M1FIA

Master Timing Tool Kit (FIAT)

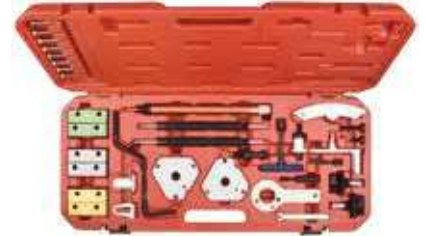

CASE WxHxD (mm)  
590 x 264 x 60

Complete kit for timing belt/chain change almost for all Fiat group diesel and petrol engines

#### Applications:

1.2, 1.4, 1.6, 1.8 16V petrol engines  
1.9D/TD, 1.9JTD, 2.4TD/JTD diesel engines

CODE NO



N15-M1FIA

1

### N15-M1PSA

Master Timing Tool Kit (CITROEN/PEUGEOT)



CASE WxHxD (mm)  
590 x 264 x 60

Complete kit for timing belt/chain change almost for all PSA group diesel and petrol engines

#### Applications:

1.0, 1.1, 1.4, 1.6, 1.6 VTS, 1.8 16V, 1.9, 2.0, 2.0 16V, 2.2 16V petrol engines  
1.4, 1.5, 1.7, 1.8, 1.9, 2.1, 2.5 D/TD/TDI diesel engines  
1.4, 1.6, 2.0, 2.2 HDI diesel engines

CODE NO



N15-M1PSA

1

# Engine Timing

## N15-K2REN

Timing Tool Kit  
(RENAULT 1.4, 1.6, 1.8, 2.0 16V)



**Applications:**

Renault: Avantime, Clio II, Clio III/Sport, Espace/Grand Espace, Kangoo/Trekka, Kangoo II/Be Bop, Laguna, Laguna II, Laguna III, Logan/MCV, Megane, Megane II, Megane III/Sport, Megane/Scenic, Modus/Grand Modus, Scenic/RX4, Scenic/Grand Scenic II, Trafic II, Twingo II/Sport / Nissan: Kubistar, Primastar / Vauxhall/Opel: Vivaro

**Engine Codes:**

K4J: 730, 732, 740  
K4M: 708, 730, 732, 752, 753, 760, 761, 764, 812, 813  
F4P: 720, 722, 760, 770, 771, 772, 773, 774, 775  
F4R: 700, 701, 712, 713, 714, 715, 720, 722, 730, 732, 740, 741, 744, 746, 762, 763, 764, 765, 766, 767, 770, 771, 774, 776, 780, 784, 786, 787, 790, 791, 792, 794, 795, 796, 797, 800, 802, 810, 811, 820, 830, 832, 867, 870, 874, 886, 887, 896, 897

CODE NO



N15-K2REN

1

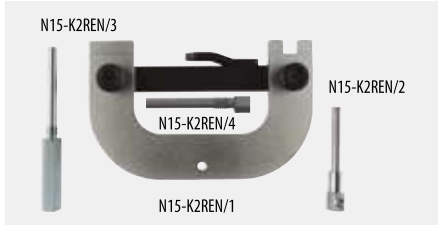

- N15-K2REN/1 Camshaft Setting Tool
- N15-K2REN/2 Crankshaft Timing Pin (A)
- N15-K2REN/3 Crankshaft Timing Pin (B)
- N15-K2REN/4 Crankshaft Timing Pin (C)

## N15-T1REN

Camshaft Sprocket Holding Tool  
(RENAULT 1.4, 1.6 16V)



For camshaft sprocket holding during timing belt change, an ideal addition to kit N15-K2REN

**Applications:**

1.4, 1.6 16V petrol engines

**Engine Codes:**

K4J: 730, 732, 740  
K4M: 708, 730, 732, 752, 753, 760, 761, 764, 812, 813

CODE NO



N15-T1REN

1

## N15-K3REN

Timing Tool Kit (RENAULT 2.2, 2.5 dCi)



Kit also suitable for Nissan and Vauxhall/Opel models, please refer to the detailed application and engine codes list

**Applications:**

Renault: Espace, Master, Trafic / Nissan: Interstar, Primastar / Vauxhall/Opel: Movano, Vivaro

**Engine Codes:**

G9U, G9T

CODE NO



N15-K3REN

1

N15-K3REN/3

1

## N15-K1FRD

Timing Tool Kit  
(FORD 2.0D, 2.2D, 2.4D TDCi/TDdi - Duratorq)



**Applications:**

Ford: Mondeo, Transit / LDV: Convoy

**Engine Codes:**

ABFA, D2FA, D2FB, D3FA, D4FA, D5BA, D6BA, D0FA, F3FA, F4FA, F5FA, F6BA, F6BB, F6FA, H9FA, HJBA, HJBB, HJBC, HJBE, N7BA, N7BB, ZSD 424

CODE NO



N15-K1FRD

1

## N15-K1UNI

Universal Timing Tool Kit



Universal kit for timing belt change on almost all car brands and models, suitable for single and twin camshaft engines

CODE NO



N15-K1UNI

1

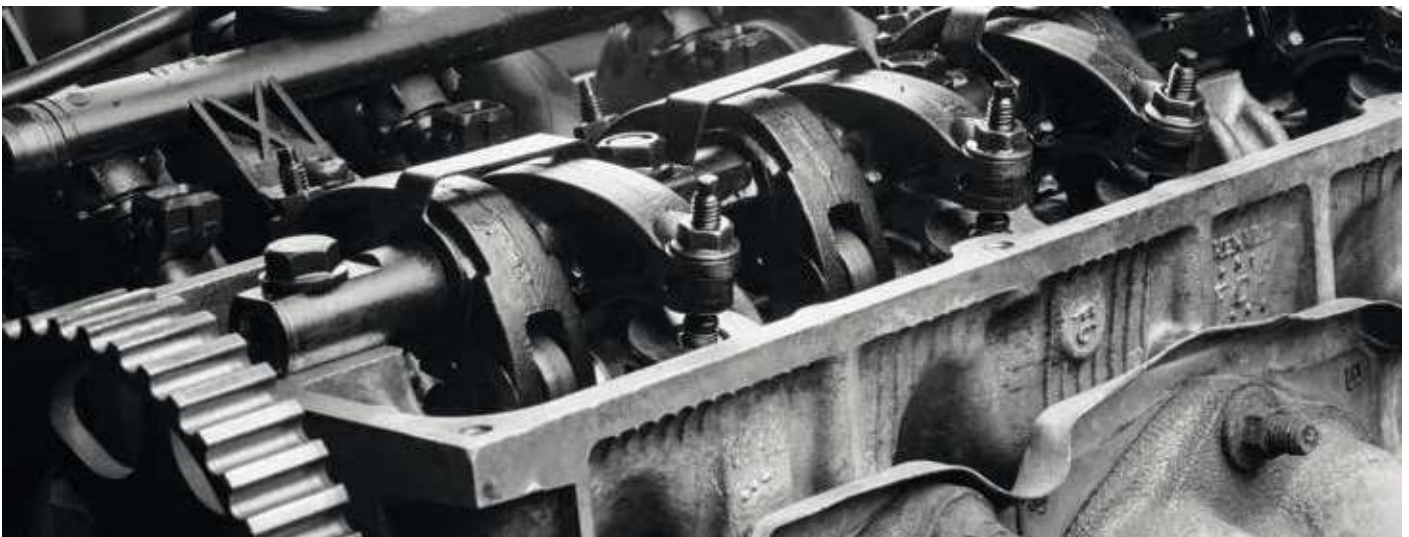

# 12 Specialist Automotive Tools

## Valve, Piston and Injectors

### N16-0101

Valve Spring Compressor



For the compression of valve springs during valve change, for most small and medium size OHV engines, parallel lift action with automatic lock

CODE NO	CAPACITY mm	mm	
N16-0101	75-225	300	1

### N16-06

13 Piece Professional Cylinder Head Service Kit



CASE WxHxD (mm)  
490 x 250 x 60

Complete kit for removal of valve springs and guides/bushings without the need to remove the head, suitable for 8V, 16V and 24V engines

CODE NO	
N16-06	1

### N16-07

Valve Stem Seal Pliers



For removal and installation of valve stem seals on 16V and 24V OHC engines, long stem, serrated tips

CODE NO	mm	
N16-07	280	6

### N16-10 Series

Piston Ring Compressors



To hold piston rings in position while inserting the pistons into cylinders, spring steel wrap, ratchet action tensioning, supplied with key

CODE NO	∅ mm	mm	
N16-1001	53-125	75	1
N16-1002	53-175	75	1
N16-1003	60-125	100	1
N16-1004	60-175	100	1
N16-1005	60-175	150	1

### N16-11 Series

Piston Ring Expanders



For assembling and dismantling piston rings

CODE NO	∅ mm	mm	
N16-1110	50-100	215	1
N16-1116	110-160	260	1

### N17-04P

Diesel Injector Puller



Suitable for removal of stubborn Bosch/Delphi injectors, slide hammer, M8/M12 and M14 adaptors

CODE NO	
N17-04P	1

### N17-052208

1/2" Drive Diesel Injector Socket - 22 mm



For removal and installation of diesel injectors

**Application:**  
Nissan, VW

CODE NO	∅ mm	mm	
N17-052208	22	78	10

### N17-052211

1/2" Drive Diesel Injector Socket - 22 mm



For removal and installation of diesel injectors

**Application:**  
Audi, BMW, Mercedes, Rover, Seat, Vauxhall/Opel, Volvo, VW

CODE NO	∅ mm	mm	
N17-052211	22	110	10

### N17-052708

1/2" Drive Diesel Injector Socket - 27 mm



For removal and installation of diesel injectors

**Application:**  
BMW, Fiat, Ford, Peugeot

CODE NO	∅ mm	mm	
N17-052708	27	78	10

# Exhaust System

## N18-10

Exhaust Spring Clamp Removal Tool (VAG)



For the removal and installation of spring clamps used to attach exhaust system to manifold (VAG vehicles), used with 17 mm wrenches

CODE NO	CAPACITY mm	mm	
N18-10	23-62	17	1

## N18-1522S

3/8" Drive Oxygen (Lambda) Sensor Socket



10  
3/8"



Suitable for heated and unheated oxygen sensors, cut-out wiring section

CODE NO	mm	mm	
N18-1522S	22	90	10

## N18-CC

# Chain Type Exhaust Cutter

- Suitable for steel, copper and PVC pipes up to 2.6 mm
- Especially recommended for cutting exhaust pipes
- 13 blade cutter chain
- Epoxy coated
- High strength sheet steel handle



CODE NO	mm	mm	
N18-CC	15-75	250	1

## N18-CCR

Spare Cutter Chain (for N18-CC)



CODE NO	mm	
N18-CCR	380	1



# 12 Specialist Automotive Tools

## Brake System and Chassis

### N21-0101 Brake Fluid Tester (8 Tests)



For testing hydraulic brake fluid quality, colour coded bulb indicators, suitable for cars, trucks and motorbikes, 1xAAA battery (included)

**Application:**

1: DOT 3, 2: DOT 4, 3: DOT 5-1, 4: ACD elco DOT 3, 5: PENNZOIL DOT 3, 6: Prestone DOT 3, 7: Motorcraft DOT 3, 8: TOYOTA DOT 3

CODE NO	mm	
N21-0101	155	10

### N21-0102 Brake Fluid Tester (DOT 4)



For testing hydraulic brake fluid quality, suitable for DOT4 brake fluids, colour coded bulb indicators, suitable for cars, trucks and motorbikes, 1xAAA battery (included)

**Application:** DOT 4

CODE NO	mm	
N21-0102	150	25

### N21-0302 Brake Fluid Bleeder Set (Pneumatic)



For the extraction of brake fluid on wheel brake cylinders / brake calipers, pneumatic, suitable for ABS brakes, supplied complete with two refill containers

CODE NO	CAPACITY litre	
N21-0302	0.75-1	1

### N21-0410 10 Piece Brake Piston Wind-Back Tool Kit



Used to mount pistons into brake calipers during the assembly of new brake pads, suitable for push-back and wind-back brakes

CODE NO	
N21-0410	1

### N21-20BC Caliper Gauge for Brake Discs



For accurate measurement of brake disc thickness, 0.1 mm graduated metric scale, floating jaw, supplied in plastic case

CODE NO	CAPACITY max.mm	
N21-20BC	60	1

### N21-10 Brake Caliper Brush



For cleaning dust from brake callipers, suitable for disc brakes, one row steel wire, high quality plastic handle

CODE NO	mm	
N21-10	220	1

### N22-0202 Coil Spring Compressor Set



Jaw design suitable for tight spaces under wheel arch, forged Chrome Molybdenum steel jaws and lead screws

CODE NO	CAPACITY mm	mm	
N22-0202	65-320	13	1

### N22-01P05 5 Piece Coil Spring Compressor Kit



CASE WxHxD (mm)  
510x400x120

limited with stocks

Suitable for MacPherson strut coil springs, 1000 kg capacity, supplied with 2 pairs of jaws, covers most car models on the market

CODE NO	
N22-01P05	1

### N22-01P08 8 Piece Coil Spring Compressor Kit



CASE WxHxD (mm)  
510x400x120

limited with stocks

Suitable for MacPherson strut coil springs, 1000 kg capacity, supplied with 3 pairs of jaws, covers most car models on the market

CODE NO	
N22-01P08	1

# Chassis

## C64W-H Series

1/2" Drive Impact Wheel Nut Sockets

**DuraMAX**



New model offers 5x the product lifetime of the "original" range, 6-point, color coded

CODE NO	mm	mm	
C64W-H17	17	86.5	6
C64W-H19	19	86.5	6
C64W-H21	21	86.5	6
C64W-H22	22	86.5	6

## C64W-P03

3 Piece 1/2" Drive Impact Wheel Nut Socket Set

**new**



CASE Width (mm)  
147 x 104 x 40

CODE NO	
C64W-P03	1

3 PC: 17, 19, 21 mm

## C64-H17MB

1/2" Drive Convex Wheel Nut Socket (Mercedes S-Class)



For use on wheel nuts on Mercedes S-Class series

CODE NO	mm	mm	
C64-H17MB	17	78	6

## N23-011

4-Way Wheel Nut Wrench

DIN 3119, ISO 6788



Special tool steel, hardened and tempered, zinc finish

CODE NO	mm	mm	
N23-011	17, 19, 21, 22	420	1

## N23-03 Series

Wheel Nut Wrenches for Trucks - Single End

TS 3793, DIN 899



For commercial vehicles

CODE NO	mm	mm	
N23-031735	17 x 35	400	1
N23-032038	20 x 38	400	1

## N23-0525

Wheel Balancing Weight Pliers



For installing, removing and cutting balance weights

CODE NO	mm	
N23-0525	240	12

## N23-0750

Tyre Lever



CODE NO	mm	
N23-0750	500 - 20"	6

## N22-01K05

# Coil Spring Compressor Kit

- Suitable for removing coil springs safely
- Maximum 1500 kg load
- Includes 2 pairs of jaws
- Suitable for most vehicles on the market

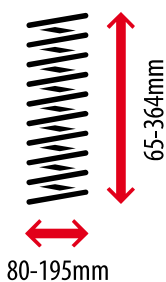

CODE NO	
N22-01K05	1

# 12 Specialist Automotive Tools

## Chassis

### N23-03K1AU

20 Piece Wheel Lock Lug Nut Socket Set (AUDI)



For clover leaf security lug nuts, use with 17 mm wheel nut sockets

CODE NO	
N23-03K1AU	1
<b>20 PC</b> No: 801, 802, 803, 504, 805, 806, 807, 808, 809, 810, 811, 812, 813, 814, 815, 816, 817, 818, 819, 820	

### N23-03K1BMW

20 Piece Wheel Lock Lug Nut Socket Set (BMW)



For clover leaf security lug nuts, use with 17 mm wheel nut sockets

CODE NO	
N23-03K1BMW	1
<b>20 PC</b> No: 41, 42, 43, 44, 45, 46, 47, 48, 49, 50, 51, 52, 53, 54, 55, 56, 57, 58, 59, 60	

### N23-03K1VW

20 Piece Wheel Lock Lug Nut Socket Set (VW)



For clover leaf security lug nuts, use with 17 mm wheel nut sockets

CODE NO	
N23-03K1VW	1
<b>20 PC</b> No: 521, 522, 523, 524, 525, 526, 527, 528, 529, 530, 531, 532, 533, 534, 535, 536, 537, 538, 539, 540	

### N23-08MC

Michelin Tyre Inflator



Official Michelin licensed product, composite body, single clip-on connector, 1.5 m hose, 1/4" air inlet, suitable for nitrogen, accuracy to UNI EN 12645:2014

CODE NO	psi - bar	
N23-08MC	145 -10	1

### N23-0811G

Tyre Inflator - Pro



63 mm dial type gauge with psi / bar indication, composite body, single clip-on connector, 1/4" air inlet

CODE NO	psi - bar	
N23-0811G	170 -12	1

### N23-0812G

Tyre Inflator



63 mm dial type gauge with psi / bar indication, die-cast body, single clip-on connector, 1/4" air inlet



CODE NO	psi - bar	
N23-0812G	170 -12	1

### N23-08TD

Digital Tyre Tread Depth Gauge



Metric and imperial readings, large display reading 0.01 mm, 1xCR2032 battery (included)



CODE NO		
N23-08TD	25	1

### N23-0825

Tyre Inflator Chuck



Zamak head, steel body (chrome finish), 1/4" air inlet, rubber handle

CODE NO			
N23-0825	1/4	250	6

### N23-0831

Tyre Pressure Gauge (for Cars)



Pen type, psi scale, features valve deflator and pocket clip, steel body (chrome finish)

CODE NO	psi		
N23-0831	10 -120	135	25

### N23-0832

Tyre Pressure Gauge (for Commercial Vehicles)



Suitable for cars and commercial vehicles, psi scale, zamak head, steel body (chrome finish)

CODE NO	psi		
N23-0832	10 -150	300	10



**N23-03 Series socket sets are not suitable for impact use**  
**CAUTION Sale to individuals is not permitted, available only for corporate sales**

# Chassis

## N23-10

### Universal Ball Joint Puller



For removing ball joint pivots of steering tie rods, stabilizers, etc., suitable for cars and light commercial vehicles

CODE NO	∅ mm	h <sup>max</sup> mm	
N23-10	22	50	1

## N23-11

### Universal Ball Joint Puller (2-Stage Lever Position)



For removing ball joint pivots of steering tie rods, stabilizers, etc., especially for German cars

CODE NO	∅ mm	h <sup>max</sup> mm	
N23-11	22	12-50	1

## N23-12 Series

### Ball Joint Pullers



For removing ball joint pivots of steering tie rods, stabilizers, etc.

CODE NO	Wxh mm	∅ mm	
N23-1218	36x38	18	1
N23-1225	45x47	25	1
N23-1230	62x66	30	1
N23-1240	62x77	40	1
N23-1246	81x81	46	1

## N23-14 Series

### Tie Rod / Ball Joint Separator



For fast removal of track rod and push rod ends, pitman arms and other parts of the steering

CODE NO	∅ mm	mm	
N23-1418	18	400	1
N23-1424	24	300	1

## N23-15 Series

### Steering Arm Removal Wrenches



For removal of steering arms, for use with 30 mm wrenches  
N23-15P: for cars, N23-15C: for commercial vehicles

CODE NO	∅ mm	mm	
N23-15P	34.5 - 39.5	430	1
N23-15C	37.5 - 44	435	1

## N23-15 Series

### Steering Arm Removal Wrenches



For removal of steering arms on vehicles, for use with 27 mm wrenches and 1/2" square drive tools

CODE NO	∅ mm	mm	
N23-1500	28-35	400	1
N23-1501	35-45	400	1

## N23-42

### Universal Clutch Aligner



For aligning / centering clutch plate to the pressure plate, for cars and commercial vehicles up to 5 tons, plastic body, supplied with 3 metal expansion mandrels

CODE NO	
N23-42	10

## N23-38

### Special Retaining Ring Pliers (Angled Jaws-Centering Hole)



For circlips on cardan shafts and gear boxes, angled tips with centering hole

CODE NO	mm	
N23-38	210	20

## N23-39

### Special Retaining Ring Pliers (Straight Jaws)



For circlips on outside lockrings (shafts) i.e.: gearboxes, chequered straight tips

CODE NO	mm	
N23-39	210	20

# 12 Specialist Automotive Tools

## Body and Trim Tools

### N31-1105

5 Piece Trim and Upholstery Removal Set



Set for trim and trim stud removal, durable polyamide material, minimum damage to panels



CODE NO	
N31-1105	1

### N31-12

Trim Clip Removal Tool



Used to remove the plastic fixing clips on door trims



CODE NO		
N31-12	150	6

### N31-13

Trim Clip Removal Pliers



Used to remove the plastic fixing clips on door trims



CODE NO		
N31-13	240	12

### N33-04

Bodywork File Holder



For 14" bodywork files, control knob to adjust curve

CODE NO		DELIVERY	
N33-04	370	N33-04F + N33-04R	1
N33-04F	370	Holder only	1



N33-04R	350	Spare File	6*
---------	-----	------------	----



### N33-04RC Series

Bodywork File (Curved Cut)

**DuraMAX**



Flat, milled curved cut, long life

CODE NO		TPI*	
N33-04R1C	350	9	12*
N33-04R2C	350	12	12*

TPI: Teeth per inch



### N33-04RD Series

Bodywork File (Diagonal Cut)

**DuraMAX**



Flat, milled diagonal cut, long life

CODE NO		TPI*	
N33-04R1D	350	9	12*
N33-04R2D	350	12	12*
N33-04R3D	350	18	12*

TPI: Teeth per inch

### N31-14

Wiper Arm Extractor



For the fast and safe removal of taper mounted windscreen wiper arms, ball-end thrust bolt

CODE NO		
N31-14	16	1

### N33-05C

Punch / Flange Combination Tool



Forms crimped edges on sheet metals, punches holes for spot-welding (MIG), time-saving tool

CODE NO		L mm	
N33-05C	5	10	1

### N36-1002

Suction Lifter (Two Heads)



For glass, tiles, plastic, sheet metal etc., push-lock levers, holds up to 80 kg in horizontal position

CODE NO			
N36-1002	115	410	1

# Pull Clamps

## N37-02SM1

Small Mouth Pull Clamp



Single way operation pull clamp for tight spaces  
Clamping Area: width 44 mm / depth 24 mm

CODE NO	CAPACITY ton	
N37-02SM1	5	1

## N37-02SJ1

Symmetric Jaw Pull Clamp



Single way operation pull clamp, symmetric jaws  
Clamping Area: width 37 mm / depth 15 mm

CODE NO	CAPACITY ton	
N37-02SJ1	3	1

## N37-02HD1

Heavy Duty Pull Clamp



Single way operation heavy duty pull clamp  
Clamping Area: width 46 mm / depth 21 mm

CODE NO	CAPACITY ton	
N37-02HD1	5	1

## N37-02SM2

Small Mouth Pull Clamp (Two Way)



Two way operation pull clamp for tight spaces  
Clamping Area: width 44 mm / depth 24 mm

CODE NO	CAPACITY ton	
N37-02SM2	5 (I) -2 (II)	1

## N37-02AJ1

Asymmetric Jaw Pull Clamp



Single way operation pull clamp, asymmetric jaws  
Clamping Area: width 37 mm / depth 15 mm

CODE NO	CAPACITY ton	
N37-02AJ1	3	1

## N37-02FR1

Frame Rack Pull Clamp



Single way operation, flat profile pull clamp  
Clamping Area: width 118 mm / depth 18 mm

CODE NO	CAPACITY ton	
N37-02FR1	5	1



# 12 Specialist Automotive Tools

## Electrical and Battery Systems

### N41-10 Battery Fluid Tester



Suitable for measuring the electrolyte density inside battery fluid, tubular composite body, easy to read indicator

CODE NO	mm	
N41-10	200	1

### G09-11 Car Electric Circuit Tester



Brass body with test light, 850 mm cable with alligator clip

CODE NO	DC (V)	
G09-11	6-24	10

### G09-16 Car Electric Circuit Tester - Pro



Spring loaded, pointed probe for testing through insulation, twin LEDs indicate live circuit and polarity, 850 mm cable with alligator clip

CODE NO	DC (V)	
G09-16	3-48	10

### N42-01M10 1/2" Drive Spline (XZN) Alternator Socket



For the removal and installation of the V-(ribbed) belt pulley on the alternator

CODE NO		mm	
N42-01M10	M10	17	25

### N42-01T50 1/2" Drive TORX Alternator Socket



For the removal and installation of the V-(ribbed) belt pulley on the alternator

CODE NO		mm	
N42-01T50	T50	17	25

### N42-01K13 13 Piece Alternator Pulley Removal Kit



CASE WxHxD (mm)  
270 x 200 x 60

Complete kit for the removal and installation of the V-(ribbed) belt pulley on the alternator

CODE NO	
N42-01K13	1

### N43-01K1UNI 12 Piece Terminal Release Tool Kit (Universal)



CASE WxHxD (mm)  
330 x 260 x 70

**Content:**  
N43-01T 12 PC: (01 + 02 + 04 + 01S + 02S + 04S + 10 + 14 + 15 + 20 + 30 + 31)

CODE NO	
N43-01K1UNI	1

### N43-01K1VAG 11 Piece VW/Audi Terminal Release Tool Kit (VAG)



CASE WxHxD (mm)  
330 x 260 x 70

**Content:**  
N43-01T 11 PC: (01 + 04 + 01S + 04S + 10 + 11 + 12 + 13 + 20 + 30 + 31)

CODE NO	
N43-01K1VAG	1

### N43-1020 20 Piece Radio Release Tool Set



Selection of keys for removal of car radios, supplied in pouch

**Applications:**  
Audio Brands: Alpine, Blaupunkt, Becker, JVC, Pioneer, VDO  
Car Models: BMW, Fiat, Ford, Mercedes, Opel, PSA, Renault, VAG

CODE NO	
N43-1020	1

# Electrical and Battery Systems

## N43-01T/01-04

Ejection Tools (for Round Contacts)



For round snap-in receptacles, including dismantling sleeve, folding handle design

**Applications:**

**N43-01T01 + N43-01T01S:** BMW, Mercedes-Benz, Fiat, MAN, Opel, Porsche, Seat, Skoda, VW/Audi

**N43-01T02 + N43-01T02S:** Ford, Opel, PSA, Renault

**N43-01T04 + N43-01T04S:** BMW, Mercedes-Benz, Fiat, MAN, Opel, Porsche, Seat, Skoda, VW/Audi

CODE NO	for contact sizes ∅ mm	
N43-01T01	1.5	1
N43-01T02	2.3	1
N43-01T04	3.5	1

## N43-01TS Series

Spare Dismantling Sleeves (for N43-01T Series)



Spare sleeves for use with N43-01T01 to N43-01T04

CODE NO		
N43-01T01S	N43-01T01	1
N43-01T02S	N43-01T02	1
N43-01T04S	N43-01T04	1

## N43-01T10

Ejection Tool (for Micro-Timer II, III Contacts)



For flat plug-in sockets, Micro-Timer II, III contacts, folding handle design

**Applications:**

Mercedes-Benz, Opel, Porsche, PSA, Renault, Saab, Seat, Skoda, VW/Audi

CODE NO	for contact sizes □ mm	
N43-01T10	1.6	1

## N43-01T11

Ejection Tool (for Flat Plug-in Sockets) - 0.64 mm



For flat plug-in sockets with asymmetrically positioned latches in terminals with two release channels, folding handle design

**Applications:** Seat, Skoda, VW/Audi

CODE NO	for contact sizes □ mm	
N43-01T11	0.64	1

## N43-01T/12-13

Ejection Tools (for Flat Plug-in Sockets)



For flat plug-in sockets with asymmetrically positioned latches in terminals with two release channels, folding handle design

**Applications:** Seat, Skoda, VW/Audi

CODE NO	for contact sizes □ mm	
N43-01T12	2.8	1
N43-01T13	4.8	1

## N43-01T14

Ejection Tool (for Flat Plug-in Sockets)



For flat plug-in sockets, Maxi Power Timer contacts, folding handle design

**Applications:**

Mercedes-Benz, VW/Audi

CODE NO	for contact sizes □ mm	
N43-01T14	9.5	1

## N43-01T15

Ejection Tool (for Pit-Pod Contacts)



For flat plug-in sockets, Pit-Pod contacts, folding handle design

**Applications:** For all vehicle makes

CODE NO	for contact sizes □ mm	
N43-01T15	various	1

## N43-01T20

Ejection Tool (for JPT/SPT Contacts)



For flat plug-in sockets in terminals with two release channels, JPT/SPT contacts, folding handle design

**Applications:** BMW, Mercedes-Benz, Fiat, Ford, MAN, Opel, PSA, Renault, Saab, VW/Audi

CODE NO	for contact sizes □ mm	
N43-01T20	2.8, 5.8	1

## N43-01T30

Ejection Tool (for Micro-Timer I Contacts)



For flat plug-in sockets, Micro-Timer I contacts and ABS plug-in housing, folding handle design

**Applications:** Fiat, Ford, Mazda, Opel, PSA, Renault, Saab, VW/Audi

CODE NO	for contact sizes □ mm	
N43-01T30	1.6	1

## N43-01T/31-32

Ejection Tools (for Standard Flat Contacts)



For flat plug-in sockets locked in terminals with single release channel, folding handle design

**Applications:**

**N43-01T31:** BMW, Mercedes-Benz, Ford, MAN, Opel, Porsche, PSA, Renault, Seat, Skoda, VW/Audi

**N43-01T32:** BMW, PSA, Renault

CODE NO	for contact sizes □ mm	
N43-01T31	2.8, 5.8	1
N43-01T32	2.8	1





# 13



## Measuring Tools



# 13 Measuring Tools

## P01 Series

### Pro Brake Tape Measures

Sets new standards in design and quality

- Blade accuracy to EC class II
- Double-side printed blades with Nylon coating for maximum durability
- Magnetic hook
- Self-locking stop mechanism for complete control when retracting blade
- ABS case in piano black finish



- 1 Magnet
- 2 Nominal length of the tape
- 3 Accuracy class
- 4 CE logo
- 5 Ec pattern approval no
- 6 Brand

CODE NO	m	mm	
P01-0522	5	22	8
P01-0527	5	27	8
P01-0827	8	27	8

## P12-40 Laser Distance Meter

EEC II accuracy class, LCD screen, 2xAAA batteries



Maximum 2mm precision deviation in 40m

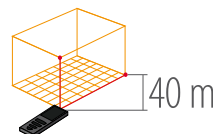

CODE NO	m	Accuracy mm	
P12-40	40	±2	1

P05B Series

# Compact Tape Measures

new

High quality at an affordable price

- Blade accuracy to EC class II
- Designed to have the smallest housing in class for easy handling
- Unique double stop mechanism
- Strong magnetic hook

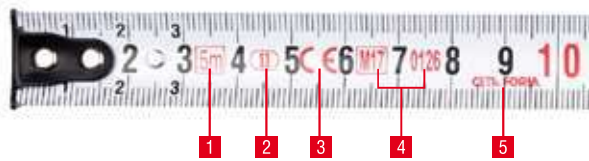

- 1 Nominal length of the tape
- 2 Accuracy class
- 3 CE logo
- 4 Ec pattern approval no
- 5 Brand

CODE NO	m	mm	
P05B-0519	5	19	8
P05B-1025	10	25	8

P05 Series  
Tape Measures

Compact



EEC class II accuracy, metric, double stop

CODE NO	m	mm	
P05-0316	3	16	12
P05-0516	5	16	12
P05-0519	5	19	12
P05-0525	5	25	12
P05-1025	10	25	8

P05A Series  
Tape Measures (Inch/Metric)

Compact



EEC class II accuracy, inch/metric, double-stop

CODE NO	m	mm	
P05A-0316	3m-10ft	16	12
P05A-0519	5m-16ft	19	12

P05S-0519  
Stainless Steel Tape Measure

Compact



StainlessSteel

All metallic components in stainless steel, perfect for wet environments, EEC class II accuracy, metric, double stop

CODE NO	m	mm	
P05S-0519	5	19	12

# 13 Measuring Tools

## Pocket Tape Measures / Long Tape Measures / Chalk Line Set

### P03 Series C-Pro Tape Measures

**new**



**C Pro**

EEC II accuracy class, metric, double side printed blade, softgrip ABS case

CODE NO	m	mm	Box
P03-0316	3	16	12
P03-0519	5	19	8
P03-0525	5	25	8

### P03N Series C-Pro Tape Measures



**C Pro**

EEC II accuracy class, metric, double side printed blade, softgrip ABS case

CODE NO	m	mm	Box
P03-0316N	3	16	12
P03-0519N	5	19	8
P03-0525N	5	25	8

### P17-B03 Chalk Line Set

**new**



Line Level included



Self-chalking line, metal end support, softgrip ABS case, folding winder, supplied complete with a bottle of chalk

CODE NO	m	Box
P17-B03	30	1

### P10 Series C-Grip Long Tape Measures (Fiberglass Blade)

**new design**



**C Grip**

EEC class II accuracy, metric, double side printed fiberglass blade, loop with retractable claw, softgrip ABS case, geared rewind mechanism

CODE NO	m	mm	Box
P10-10	10	15	1
P10-20	20	15	1
P10-30	30	15	1

### P07 Series C-Pro Long Tape Measures (Steel Blade)

**new design**



**C Pro**

EEC class II accuracy, metric, steel blade, loop with retractable claw, ergonomic plastic frame, geared rewind mechanism

CODE NO	m	mm	Box
P07-20	20	13	1
P07-30	30	13	1
P07-50	50	13	1

### 29100D Dipping Weight (for 29100 Series)



Engraved scale, MS58 brass material

CODE NO	mm	Weight	Box
29100D	100	500	1

### P05-AD2 Adhesive Tape Measure



EEC class II accuracy adhesive tape, can be cut to size, ideal for workbenches, saw tables, counters etc.

CODE NO	m	mm	Box
P05-AD2	2	13	12

### 29100 Series Tank Dipping Tape Measures (Stainless Steel Blade)



StainlessSteel



For depth measurement of liquids in tanks or silos, EEC class II accuracy, stainless steel blade, aluminium frame construction  
**Tapes ship with 29100D dipping weight**

CODE NO	m	mm	Box
29110	10	13	1
29120	20	13	1

## Vernier Calipers

### P45D Digital Vernier Caliper



Metric and imperial reading, large display reading 0.01 mm and 0.0005", zero setting control, depth gauge, stainless steel body, 1xSR44 battery (included), supplied in plastic case

CODE NO		
P45D	150 mm	10

### P45A Series Vernier Caliper



Metric reading 0.02 mm, depth gauge, stainless steel body, supplied in plastic case

CODE NO		
P45A	150 mm	10

## Micrometers / Gauges / Rulers

### P47 Series External Micrometers



0.01 mm graduations, clamping ring and ratchet stop, carbide tipped anvils, heat plates, supplied in plastic case

CODE NO		
P47-025	0- 25 mm	1
P47-050	25- 50 mm	1
P47-075	50- 75 mm	1
P47-100	75-100 mm	1

### P15 Series Stainless Steel Rules



**StainlessSteel**

Precision class II, metric, stainless steel, photoengraved, anti-reflection treatment, supplied in pouch

CODE NO			
P15-015	15	13	50
P15-030	30	25	10
P15-050	50	30	10
P15-100	100	30	10

### P54-20S Feeler Gauge (Metric-20 Blade)



100 mm long tapered blades, hardened and polished, steel case with thumbscrew

CODE NO	mm		
P54-20S	0.05-1.00	100	6

### P54A-25S Feeler Gauge (SAE-25 Blade)



100 mm long tapered blades, hardened and polished, steel case with thumbscrew

CODE NO	inch		
P54A-25S	0.0015-0.025	100	6

### P55-52MW Screw Pitch Gauge (Metric / Whitworth - 52 Blade)



For ISO 60° metric and Whitworth 55° threads, stainless steel  
Metric: 0.25, 0.30, 0.35, 0.40, 0.45, 0.5, 0.6, 0.7, 0.75, 0.8, 0.9, 1.0, 1.25, 1.5, 1.75, 2.0, 2.5, 3.0, 3.5, 4.0, 4.5, 5.0, 5.5, 6.0 mm  
Whitworth: 4, 4-1/2, 5, 6, 7, 8, 9, 10, 11, 12, 13, 14, 16, 18, 19, 20, 22, 24, 25, 26, 28, 30, 32, 36, 40, 48, 60, 62 TPI

CODE NO	mm	W	
P55-52MW	0.25-6	62-4	5



# 13 Measuring Tools

## Spirit Levels

### Aluminium Spirit Levels

Top quality range of spirit levels developed for construction professionals. Each level calibrated in the factory. Magnet and non-magnet versions available.

30 Years Vial Warranty

**ACCUVISION**

#### P21 Series



Pro quality, 0.5 mm/m (0.029°) accuracy, ultrasonic welded block vials, shockproof end caps, rigid aluminium box section

CODE NO	cm	
P21-030	30	10
P21-040	40	10
P21-050	50	10
P21-060	60	10
P21-070	70	10
P21-080	80	10
P21-100	100	10
P21-120	120	10
P21-150	150	10

#### P21-M Series Magnetic



Pro quality, 0.5 mm/m (0.029°) accuracy, ultrasonic welded block vials, shockproof end caps, rigid aluminium box section, built-in rare earth magnets

CODE NO	cm	
P21-060M	60	10
P21-080M	80	10
P21-100M	100	10

#### P21-012M Handy Type



**new**



Pro quality, 0.5 mm/m (0.029°) accuracy, ultrasonic welded block vials, shockproof end caps, rigid aluminium box section, built-in magnets, for horizontal measurement

CODE NO	cm	
P21-012M	12	10

#### P24M-022 Torpedo / Cast Body



Pro quality, 3 vials, 0.50 mm/m (.0029°) accuracy, ultrasonic welded block vials, built-in magnets

CODE NO	cm	
P24M-022	22	12

#### P26 Series Level Vials

Fluorescent liquid, ultrasonic welded, acrylic body



CODE NO	mm	mm	mm	
P26-BE1	18	9	-	12•
P26-BV1	36	17	-	12•
P26-BV2*	35	16	-	12•
P26-BH1	-	15	36	12•
P26-BH2*	-	15x16	40	12•
P26-SH1	9.5	-	31	50•
P26-SH2*	9.8	-	30	12•

\* Limited with stocks

14

**CETA FORM**®

General Maintenance and Workshop Tools

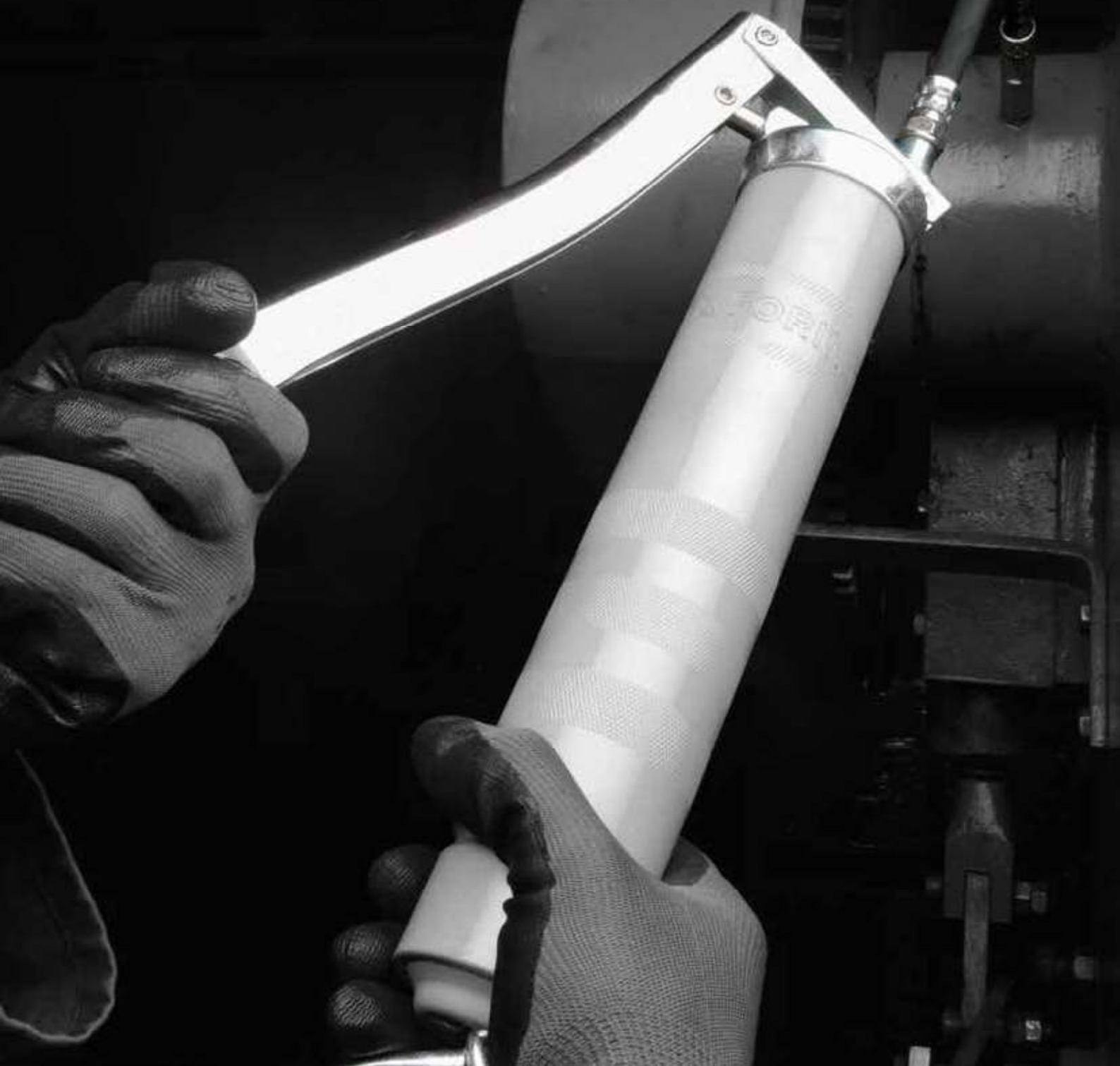

# 14 General Maintenance and Workshop Tools



## Cordless Work Lamps

Today's complex vehicles and machineries often challenge the mechanics with respect to lighting needs. The challenge is even harder when working in areas with no power supply. Ceta Form's LuMAX family of work lamps is the ideal partner for such occasions. Unique powerful and completely uniform illumination are the built-in characteristics of all lamps in this family.

R10-MAX1



700  
lumens

- 120 LUMENS
- 3 LEVELS
- 180° Adjustable Handle
- Magnet Back & Bottom
- USB Type C

R10-MAX2



400  
lumens

- 120 LUMENS
- 2 LEVELS
- 180° Adjustable Handle
- Magnet Back & Bottom
- Micro USB

R10-CL1



220  
lumens

- 80 LUMENS
- 90° Adjustable Handle
- Magnet Bottom
- Micro USB

### R10-MAX1

#### Rechargeable LED Work Light

**Main Light:** Super bright 6W COB LED 700 lumens

**Top Light:** Super bright 3W SMD LED 120 lumens

CRI: 80 CRI+ CCT: 6500K

**Battery:** 3.7V 2600 mAh Li-ion

**Runtime:** Main Light up to 5h / Top Light 7h

**Charging time:** 4h

IP65 / IK07

Battery level indicator

### R10-MAX2

#### Rechargeable LED Work Light

**Main Light:** Super bright 4W COB LED 400 lumens

**Top Light:** Super bright 3W SMD LED 120 lumens

CRI: 80 CRI+

CCT: 6500K

**Battery:** 3.7V 2600 mAh Li-ion

**Runtime:** Main Light up to 3h 30 mins / Top Light 7h

**Charging time:** 3h 30 mins

IP54 / IK07

### R10-CL1

#### Rechargeable LED Work Light

**Main Light:** 5 x 0.5W SMD LED 220 lumens

**Top Light:** 1 x 3W SMD LED 80 lumens

CRI: 80 CRI+

CCT: 6500K

**Battery:** 3.7V 2200 mAh Li-ion

**Runtime:** Main Light up to 3h 30 mins / Top Light 12h

**Charging time:** 4h

IP54 / IK07



## ColorFix Color Proofing LED Lamp

Due to the special LED features, this lamp replicates daylight. Perfect for any paint, polish, cleaning or prep-zone operation. Supplied with a replaceable glass lens resistant to all kinds of solvents and tolerating daily cleaning.

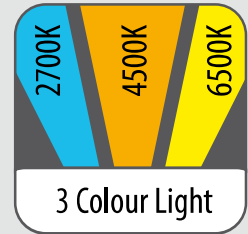

R10-MIDI



**600 lumens**



R10-CLR



**500 lumens**



R10-MD/S



### R10-MIDI

#### Midi Rechargeable LED Work Light

**Main Light:** Super bright 6W COB LED 600 lumens

**Top Light:** Super bright 1W SMD LED 120 lumens

**CRI:** 80 CRI+

**CCT:** 6500K

**Battery:** 3.7V 2600 mAh Li-ion

**Runtime:** Main Light up to 4h 30 mins / Top Light 10h

**Charging time:** 4h

IP54 / IK07

### R10-CLR

#### Rechargeable Color Proofing LED Work Light

**Main Light:** Super bright high CRI and three CCT

5W COB LED 500 lumens

**CRI:** 96 CRI+

**CCT:** 2700K - 4500K - 6500K

**Battery:** 3.7V 2600 mAh Li-ion

**Runtime:** Up to 2h 30 mins

**Charging time:** 4h

IP65 / IK07

### R10-MD/S

#### Charging Stand

Charging Stand for R10-MIDI, R10-CLR

# 14 General Maintenance and Workshop Tools

R10-MINI



120 lumens



R10-SLIM



Hook on Bottom



Stepless Dimming Switch



360° Adjustable Base

700 lumens



R10-COM



300 lumens



## R10-MINI

### Mini Rechargeable LED Work Light

**Main Light:** 7 x 0.5W SMD LED 120 lumens

**Top Light:** 1 x 1W SMD LED 100 lumens

**CRI:** 80 CRI+

**CCT:** 6500K

**Battery:** 3.7V 750 mAh Li-ion

**Runtime:** Main Light up to 3.5h / Top Light 4.5h

**Charging time:** 2h 30 mins

IP20 / IK07

## R10-SLIM

### Slim Rechargeable LED Work Light

**Main Light:** Super bright 7W COB LED 700 lumens

**Top Light:** Super bright 3W SMD LED 120 lumens

**CRI:** 80 CRI+ **CCT:** 6500K

**Battery:** 3.7V 2600 mAh Li-ion

**Runtime:** Main Light up to 16h / Top Light 7h

**Charging time:** 4h

IP54 / IK07

Battery level indicator

## R10-COM

### Compact Rechargeable LED Work Light

**Main Light:** 5 x 0.5W SMD LED 300 lumens

**CRI:** 80 CRI+

**CCT:** 6500K

**Battery:** 3.7V 1500 mAh Li-Po

**Runtime:** Up to 8h 30 mins

**Charging time:** 2h

IP54 / IK07

R14-CF07

700 lumens



R14-CF14

1400 lumens



R12-COB

120 lumens



**LED Headlamp**

Main Light: 3W COB LED 120 lumens

CRI: 80 CRI+

CCT: 6500K

Battery: 3xAAA batteries (not included), IPX4

R12-PRO

300 lumens



**R14-CF07**

**Rechargeable Compact LED Floodlight**

**Floodlight:** Super bright 7W COB LED 700 lumens

**Flashlight:** Super bright 3W COB LED 250 lumens

CRI: 80 CRI+ CCT: 6500K

**Battery:** 3.7V 2600 mAh Li-ion

**Runtime:** Floodlight up to 14h / Flashlight 4h

**Charging time:** 4h 30 mins

IP65 / IK07

Battery level indicator

**R14-CF14**

**Rechargeable Compact LED Floodlight**

**Floodlight:** Super bright 15W COB LED 1400 lumens

**Flashlight:** Super bright 5W COB LED 400 lumens

CRI: 80 CRI+ CCT: 6500K

**Battery:** 3.7V 5200 mAh Li-ion

**Runtime:** Floodlight up to 14h / Flashlight 6h

**Charging time:** 4h 30 mins

IP65 / IK07

Battery level indicator

**R12-PRO**

**Rechargeable LED Headlamp (Motion Sensor)**

**Main Light:** Super bright 3W COB LED 300 lumens

CRI: 80 CRI+

CCT: 6500K

**Battery:** 3.7V 1500 mAh Li-Po

**Runtime:** Up to 5h 30 mins

**Charging time:** 2h 30 mins

IP65 / IK07

# 14 General Maintenance and Workshop Tools

**LU-MAX PRO**

## Professional Focus Flashlights

The top flashlight programme of Ceta Form

R.P-BP

This range is developed to the needs of the most demanding user profiles. From batteries to LED chips, aluminium material to chipboards all components used are of top-notch quality. Any professional user will appreciate the performance and build quality after a short period of use.



**R.P-BP**  
**High Quality Tetron Belt Pouch**  
 Fits R.P6, R.P7, R.P7R

R.P6



**250 lumens**



R.P7



**450 lumens**

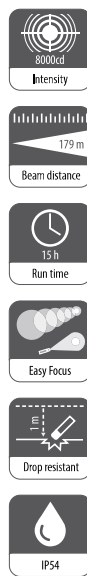

R.P7R



**1000 lumens**



**R.P6**  
**Focus Flashlight 2AA**

LED CREE XPG2 S3  
 MOD On/Off  
 Output 250 lumens  
 Run Time 9h  
 2xAA battery (included)  
 Beam Distance 89 m  
 Intensity 2000cd

**R.P7**  
**Focus Flashlight 4AAA**

LED CREE XPG2 S3  
 MOD High/Low  
 Output 50/450 lumens  
 Run Time 2-15h  
 4xAA battery (included)  
 Beam Distance 179 m  
 Intensity 8000cd

**R.P7R**  
**Rechargeable Focus Flashlight**

LED CREE XPG2 S4  
 MOD Low/Middle/High/Hidden Strobe/SOS  
 Output 50/150/500/1000 lumens  
 Runtime 2h-3h-7h-20h  
 2600 mAh Li-Ion battery (18650)  
 Beam Distance 66 m  
 Intensity 1100cd

**LU-MAX**

## LED Flashlights

A range of sturdy, compact and powerful flashlights

Comes with focus function on most models for concentrated and focused light beam.  
Aluminium models from military grade high quality material; plastic models from impact proof plastics. All models with either strap or pocket clip.



### R11-PRO

#### LED Flashlight

3W LED  
10-105 lumens  
Aluminium body  
Zoom feature  
3xAAA batteries (included)  
Pack Quantity: 12

### R11-PEN

#### Stylus LED Flashlight

1W LED  
100 lumens  
Aluminium body  
Zoom feature  
2xAAA batteries (not included)  
Pack Quantity: 12

### R11C

#### Pocket LED Flashlight

1W LED  
70 lumens  
Rubberized plastic body  
Zoom feature  
3xAAA batteries (not included)  
Pack Quantity: 12

### R15-MPL

#### LED Flashlight (with Magnetic Pickup)

3x Bright LED  
Powerful pickup magnet  
Telescoping flexible shaft  
Built-in bottom magnet  
4xLR44 batteries (included)  
Pack Quantity: 12

# 14 General Maintenance and Workshop Tools

## Mechanical Pullers

### M01 Series

Two Arm Universal Pullers



Can be used as internal and external puller by inverting the hooks, durable spindle

CODE NO	W mm	H mm	
M01-0810	80	100	1
M01-1310	130	100	1
M01-1615	160	150	1
M01-2015	200	150	1
M01-2520	250	200	1
M01-3520	350	200	1

### M01-S05

5 Piece Two Arm Universal Puller Display



CODE NO	
M01-S05	1

5 PC: M01-0810, M01-1310, M01-1615, M01-2015, M01-2520

### M05 Series

3-Arm Pullers (Self Centering Jaws)



Automatic centering, durable spindle

CODE NO	W mm	H mm	
M05-1008	100	80	1
M05-1212	120	120	1
M05-1616	160	160	1
M05-2020	200	200	1

### M10S Series

Flat Separators



Separator is closed by tightening nuts on stud bolts, in conjunction with M10P series

CODE NO	∅ mm	
M10S-0460	4- 60	1
M10S-0680	6- 80	1
M10S-1011	10-110	1

### M10P Series

Puller for Separators



For extraction of ball bearings, roller bearings and inner rings, in conjunction with M10S series

CODE NO	for	
M10P-60	M10S-0460	1
M10P-80	M10S-0680	1
M10P-11	M10S-1011	1

### M20-KIT1

Bearing Extractor Kit



Helps catch bearings between the races by properly shaped tips in kit. For 6004, 6010, 6200, 6205, 6300, 6304, 61812, 61816 bearings

CODE NO	∅ mm	
M20-KIT1	20-95	1

## Hand Riveters

### R01-STD

Hand Riveter (New Generation) new



For aluminium, steel and stainless steel rivets, interchangeable nose pieces, aluminium body

CODE NO	mm	
R01-STD	2.4 - 3.2 - 4.0 - 4.8	1

### R01-260

Hand Riveter



For aluminium, steel and stainless steel rivets, interchangeable nose pieces, aluminium body, forged steel handle

CODE NO	mm	
R01-260	2.4 - 3.2 - 4.0 - 4.8	1

### R02-280

Hand Riveter (Swivel Head)



For aluminium, steel and stainless steel rivets, 360° swiveling head, interchangeable nose pieces, aluminium body

CODE NO	mm	
R02-280	2.4 - 3.2 - 4.0 - 4.8	1

### R01-AS1

Hand Riveter (for Cherry® rivets) new



Particularly for Cherry rivets widely used in the aerospace industry, long nose design, aluminium body

CODE NO	mm	inch	
R01-AS1	2.4 - 3.2 - 4.0	3/32 - 1/8 - 5/32	1

# Hand Riveter Sets

## R03K

Hand Riveter Kit (for Nuts/Rivets)



CASE WxHxD (mm)  
320X140X40



YouTube Clip



YouTube Clip

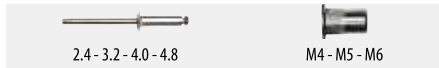

2.4 - 3.2 - 4.0 - 4.8

M4 - M5 - M6

For blind rivets and rivet nuts, riveter: aluminium body, forged steel handle, supplied as a complete kit

CODE NO	M	
R03K		1
<b>Content:</b>		
Hand riveter (1 pc.), Wrench (1 pc.), Adaptor nut (1 pc.)		
Rivet head (4 pc.), Rivet nut and bolt head (3 pc.)		

## R03K-M Series

Replacement Nozzle Bolts (for R03K)



CODE NO	M	
R03K-M04	M4	6•
R03K-M05	M5	6•
R03K-M06	M6	6•

## R03K-S Series

Replacement Nozzle Nuts (for R03K)



CODE NO	M	
R03K-S04	M4	6•
R03K-S05	M5	6•
R03K-S06	M6	6•

## R04K

Long Reach Riveter Kit (for Nuts/Rivets)



YouTube Clip



YouTube Clip

CASE WxHxD (mm)  
340X220X50



3.2 - 4.0 - 4.8 - 6.4



M4 - M5 - M6 - M8 - M10

For blind rivets and rivet nuts, foldable body riveter, very strong compared to regular riveters

CODE NO	M	
R04K		1
<b>Content :</b>		
Long reach riveter (1 pc.), Wrenches (3 pc.), Rivet head (5 pc.)		
Rivet head adaptor nut (1 pc.), Rivet head bolt (5 pc.),		
Rivet nut bearing nut loaf (5 pc.), Rivet nut adaptor (1 pc.)		

## R03K-PT

2-in-1 Power Tool Attachment for Rivets and Nuts

**new**

Rivet Adaptor



3.2 - 4.0 - 4.8 - 6.4

Rivet Nut Adaptor



M4 - M5 - M6 - M8 - M10



CASE WxHxD (mm)  
300X90X200

Easily converts cordless, pneumatic or corded drills into a power rivet / rivet nut setter, features durable bearings, supplied complete with accessories in a plastic case

CODE NO		
R03K-PT		1



## R04K-M Series

Replacement Nozzle Bolts (for R04K)



CODE NO	M	
R04K-M04	M4	6•
R04K-M05	M5	6•
R04K-M06	M6	6•
R04K-M08	M8	6•
R04K-M10	M10	6•

## R04K-S Series

Replacement Nozzle Nuts (for R04K)



CODE NO	M	
R04K-S04	M4	6•
R04K-S05	M5	6•
R04K-S06	M6	6•
R04K-S08	M8	6•
R04K-S10	M10	6•

## R04K-AS

Rivet Nut Adaptor (for R04K)



CODE NO		
R04K-AS		6•

# 14 General Maintenance and Workshop Tools

## Magnetic Pickups and Inspection Mirrors

### R15 Series

Magnetic Pick-Up Tools (Flexible Shaft)



For collecting metal parts from restricted areas, powerful rare earth magnet, flexible shaft, C-PLUS softgrip handle

CODE NO	g	mm	
R15-0500	500	510	6
R15-1000	1000	510	6
R15-1800	1800	510	6
R15-3000	3000	510	6

### R15-NTM

Telescoping Magnetic Pick-Up Tool (with Nozzle Adjuster)



For collecting metal parts from restricted areas, powerful rare earth magnet, includes a scriber useful for adjusting the nozzles of the washing system, telescoping shaft, metal clip

CODE NO	mm	
R15-NTM	150-675	1

### R20RS

Telescoping Inspection Mirror (Round-M)



Steel base mounted mirror, flexible head, telescoping shaft (750 mm in extended position), metal clip

CODE NO	mm	mm	
R20RS	30	250-750	25

### R15-TM10

Telescoping Magnetic Pick-Up Tool



For collecting metal parts from restricted areas, powerful rare earth magnet, telescoping shaft, metal clip

CODE NO	g	mm	
R15-TM10	1000	170-870	25

### R16-700

Magnetic Pick-Up and Claw Tool (Flexible Shaft)

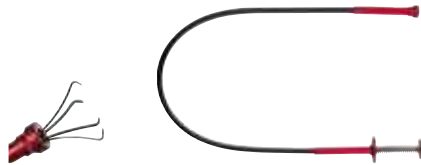

Expandable/retractable claw and pickup magnet in one tool, claw control by handle, flexible shaft

CODE NO	g	mm	
R16-700	500	700	25

### R20S

Telescoping Inspection Mirror (Square)



Steel base mounted mirror, flexible head, telescoping shaft (725 mm in extended position), stainless steel body

CODE NO	W x H mm	mm	
R20S	45x63	230-725	25

### R15-HTM

Heavy Duty Telescoping Magnetic Pick-Up Tool



For collecting metal parts from restricted areas, powerful rare earth magnet, telescoping shaft, vinyl grip

CODE NO	g	mm	
R15-HTM	2200	425-680	12

### R20R

Telescoping Inspection Mirror (Round-L)



Steel base mounted mirror, flexible head, telescoping shaft (900 mm in extended position), stainless steel body

CODE NO	mm	mm	
R20R	50	250-900	25

### R20RP

Insulated Round Inspection Mirror



Steel base mounted mirror, fixed offset head, stainless steel body

CODE NO	mm	mm	
R20RP	30	175	12

## Lubrication Tools

### R08-500

Grease Gun (Hand Type-Metal Spout)

DIN 1283, TS 7844



400 bar feed pressure, metal spout, sheet steel body, powder coated finish

CODE NO	CC	mm	Icon
R08-500	500	300	1

### R05 Series

Metallic Oil Cans (Metal Spout)



Metal spout, sheet steel body, powder coated finish

CODE NO	CC	Icon
R05-200	200	12
R05-300	300	12
R05-500	500	12
R05-1000	1000	6

### R08-500SN

Spare Nozzle (for R08-500)



Four jaw steel connector, M10 x 1.0 mm female thread

CODE NO	mm	Icon
R08-500SN	38	6

### R08-FS Series

Spare Flexible Spouts



High pressure reinforced rubber tube, M10 x 1.0 mm male threads

CODE NO	Description	mm	ex code	Icon
R08-FSN	with nozzle	330	R08-500SF	6
R08-FSY	without nozzle	300	-	6

## Magnetic Trays

### R18S

Magnetic Tray (Rectangular)



StainlessSteel



For collection of metal parts, stainless steel, magnetic base

CODE NO	WxHxD	Icon
R18S	240x140x40	1

### R18R

Magnetic Tray (Round)



StainlessSteel



For collection of metal parts, stainless steel, magnetic base

CODE NO	mm	Icon
R18R	150	1

### R09B Series

## Bench Vices

A Ceta Form bench vice is a tool of highest quality. Made purely of steel with guaranteed robustness - almost indestructible!

Induction hardened jaws



Centrally located and well-protected spindle allows for high and optimally balanced force



CODE NO	JAW WIDTH mm	CAPACITY mm	Icon
R09B-125	125	130	1
R09B-150	150	155	1
R09B-200	200	205	1

# 14 General Maintenance and Workshop Tools

## C-Coil Damaged Thread Repair Kits

### R28-M130

130 Piece C-Coil Damaged Thread Repair Kit



**BOX WxHxD (mm)**  
357 X 235 X 28

**Application:**  
M5, M6, M8, M10, M12 threads

Kit for the repair of damaged or worn-out threads, high quality Chrome Nickel stainless steel female threads, HSS drill bits/taps, special tool steel tangs/pins

CODE NO	
R28-M130	1

	M5x0.8, M6x1.0, M8x1.25, M10x1.5, M12x1.75
	5.2, 6.3, 8.3, 10.4, 12.4 mm
	No. : 8, 9, 11, 13, 15
	No. : 8, 9, 11, 13, 15
	M5x0.8, M6x1.0, M8x1.25, M10x1.5 (25 pc. each) M12x1.75 (10 pc.)

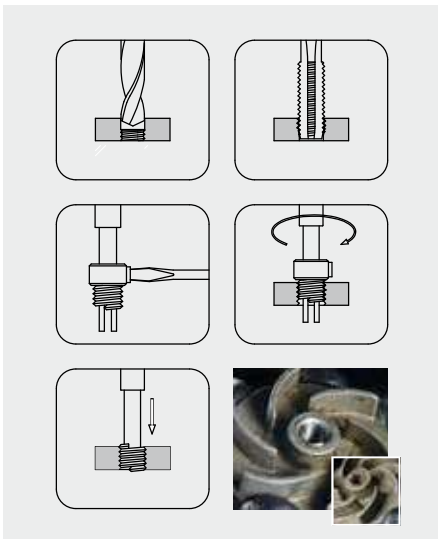

Chapter /12 Page 235



### R28-P0524

24 Piece M5 C-Coil Damaged Thread Repair Kit



**BOX WxHxD (mm)**  
245 X 125 X 40

Kit for the repair of damaged or worn-out threads (M5)

CODE NO	
R28-P0524	1

	M5x0.8		No. 8
	5.2 mm		No. 8
	M5x0.8 (20 pc.)		

### R28-P0624

24 Piece M6 C-Coil Damaged Thread Repair Kit



**BOX WxHxD (mm)**  
245 X 125 X 40

Kit for the repair of damaged or worn-out threads (M6)

CODE NO	
R28-P0624	1

	M6x1.0		No. 9
	6.3 mm		No. 9
	M6x1.0 (20 pc.)		

### R28-P0824

24 Piece M8 C-Coil Damaged Thread Repair Kit



**BOX WxHxD (mm)**  
245 X 125 X 40

Kit for the repair of damaged or worn-out threads (M8)

CODE NO	
R28-P0824	1

	M8x1.25		No. 11
	8.3 mm		No. 11
	M8x1.25 (20 pc.)		

### R28-P1019

19 Piece M10 C-Coil Damaged Thread Repair Kit



**BOX WxHxD (mm)**  
245 X 125 X 40

Kit for the repair of damaged or worn-out threads (M10)

CODE NO	
R28-P1019	1

	M10x1.5		No. 13
	10.4 mm		No. 13
	M10x1.5 (15 pc.)		

### R28-P1214

14 Piece M12 C-Coil Damaged Thread Repair Kit



**BOX WxHxD (mm)**  
245 X 125 X 40

Kit for the repair of damaged or worn-out threads (M12)

CODE NO	
R28-P1214	1

	M12x1.75		No. 15
	12.4 mm		No. 15
	M12x1.75 (10 pc.)		

### R28-SC Series

C-Coil Thread Inserts - 10 Pieces



High quality Chrome Nickel stainless steel, resistant against corrosion and wearing

The code represents a 10 piece package

CODE NO				
R28-SC05	M5	0.80		1 pack
R28-SC06	M6	1.00		1 pack
R28-SC08	M8	1.25		1 pack
R28-SC10	M10	1.50		1 pack
R28-SC12	M12	1.75		1 pack
R28-SC14/1	M14	1.25	7.7	1 pack

# Screw and Bolt Extractors / HSS Drill Bits

## R25-P05

5 Piece Screw Extractor Set

**new**  
design



For turning out worn/broken screws with left handed thread, Chrome Molybdenum steel

CODE NO



R25-P05

6

5 PC: 7/64" (3-6 mm), 9/64" (6-8 mm), 5/32" (8-11 mm), 1/4" (11-14 mm), 19/64" (14-18 mm)

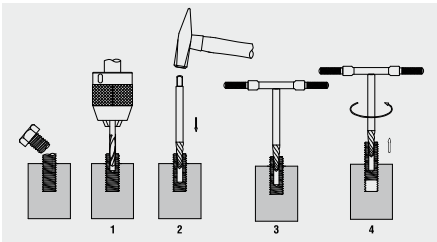

## R30 Series

1/2" Drive Roller Stud Extractor Sockets

12.5  
1/2"



For installing and removing stud bolts, roller type, unscrews both left and right hand threads

CODE NO

M

mm



CODE NO	M	mm	
R30-06	M6	60	1
R30-08	M8	60	1
R30-10	M10	69	1
R30-12	M12	69	1

## R30-R04

4 Piece 1/2" Drive Roller Stud Extractor Set

**new**  
design



12.5  
1/2"

CODE NO



R30-R04

6

4 PC: M6, M8, M10, M12

## R26-M25

25 Piece Screw Extractor Kit



BOX WxHxD (mm)  
245X125X40

Kit for turning out broken bolts and screws, HSS drill bits, special tool steel guides, pins and sleeves

Application:

M5, M6, M7, M8 (2 pc.), M9, M10, M11, M12, M14, M16 for bolts

CODE NO



R26-M25

1

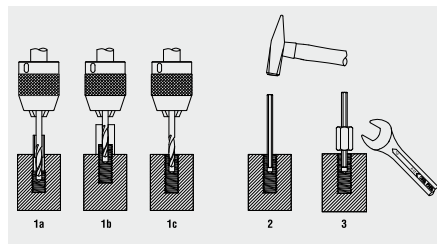

## R32 Series

1/2" Bolt Extractor Sockets



12.5  
1/2"



Special sockets for removal of even extremely worn-out bolts, helix socket profile

CODE NO

mm

mm



CODE NO	mm	mm	
R32-10	10	34	6
R32-11	11	34	6
R32-12	12	34	6
R32-13	13	34	6
R32-14	14	34	6
R32-15	15	34	6
R32-16	16	34	6
R32-17	17	34	6
R32-19	19	34	6
R32-21	21	34	6
R32-22	22	34	6
R32-24	24	34	6
R32-27	27	34	6

## R21-P19

19 Piece HSS Drill Bit Set



High quality HSS drill bits, 118° standard point

CODE NO



R21-P19

1

19 PC: 1.0, 1.5, 2.0, 2.5, 3.0, 3.5, 4.0, 4.5, 5.0, 5.5, 6.0, 6.5, 7.0, 7.5, 8.0, 8.5, 9.0, 9.5, 10.0 mm

## R32-M10

10 Piece 1/2" Drive Bolt Extractor Socket Set

**new**  
design



12.5  
1/2"



12.5  
1/2"

CODE NO



R32-M10

6

10 PC: 10, 11, 12, 13, 14, 15, 16, 17, 19 mm + removal pin

# 14 General Maintenance and Workshop Tools



## Hooks & Picks / Wire Brushes / Other Workshop Tools

**R36-1**  
Straight Pick



**StainlessSteel**

Suitable for removal of bushings, cotter pins, O-rings and seals, stainless steel shaft



CODE NO		
R36-1	80	6

**R36-2**  
Angle Pick



**StainlessSteel**

Suitable for removal of bushings, cotter pins, O-rings and seals, stainless steel shaft

CODE NO		
R36-2	80	6

**R37-25**  
Seal Scraper





Ideal for cleaning gasket wastes

CODE NO			
R37-25	25	150	6

**CM-B0**  
Bottle Opener

**new**



CODE NO		
CM-B0	145	12

**R36-3**  
90° Pick



**StainlessSteel**

Suitable for removal of bushings, cotter pins, O-rings and seals, stainless steel shaft



CODE NO		
R36-3	80	6

**R36-4**  
Hook Pick



**StainlessSteel**

Suitable for removal of bushings, cotter pins, O-rings and seals, stainless steel shaft

CODE NO		
R36-4	80	6

**R35DE**  
Engineer's Double End Scriber





For marking metals and other smooth surfaces, hardened steel tips, straight and 90° ends

CODE NO		
R35DE	235	1

**R35CT**  
Carbide Tipped Scriber



For marking metals and other materials with smooth surfaces, carbide tip, pocket clip

CODE NO		
R35CT	145	20

**R36-B04**  
4 Piece Hook and Pick Set



**StainlessSteel**



CODE NO	
R36-B04	1



**R40-4**  
Steel Wire Brush (4 Row)





Brushes made of steel wire, 4 rows, high quality plastic handle

CODE NO		
R40-4	275	12

**R41-1**  
Steel Wire Brush



Brushes made of steel wire, high quality plastic handle

CODE NO		
R41-1	245	12