

CONJUNTOS DE FERRAMENTAS

CONJUNTOS DE FERRAMENTAS	8	CONJUNTO DE ADAPTADORES	31
CONJUNTOS DE CHAVES DE CAIXA	16	KIT DE PONTAS	32
CAIXAS / MALETAS DE FERRAMENTAS	22	KIT DE CHAVES DE CAIXA	33
CONJUNTOS DE PONTAS	27	FERRAMENTAS COM ISOLAMENTO	34
CONJUNTO DE CATRACAS MINI	31		



CONJUNTOS DE FERRAMENTAS

CAIXA DE FERRAMENTAS DE 216 PEÇAS COM CHAVES HEXAGONAIS

REF.	1/4"	3/8"	1/2"	PCS	PERFIL	ACABADO					€
54034	•	•	•	216		Zincado	11.45	-	2	48	178,00€
54045	•	•	•	216		Cromado	11.45	-	2	48	179,00€

54034



REPOSIÇÕES DISPONÍVEIS

54045



REPOSIÇÕES DISPONÍVEIS



	1/2"	x14	13, 14, 15, 16, 17, 18, 19, 20, 21, 22, 24, 27, 30, 32mm
	3/8"	x10	10, 11, 12, 13, 14, 15, 16, 17, 18, 19mm
	1/4"	x13	4, 4.5, 5, 5.5, 6, 7, 8, 9, 10, 11, 12, 13, 14mm
	1/2"	x5	16, 17, 18, 19, 22mm
	3/8"	x6	10, 11, 12, 13, 14, 15mm
	1/4"	x7	4, 5, 6, 7, 8, 9, 10mm
	1/2"	x3	E20, E22, E24
	3/8"	x6	E10, E11, E12, E14, E16, E18
	1/4"	x5	E4, E5, E6, E7, E8
	7/32"	x3	1/2", 3/8", 1/4"
	1/2"	x2	125, 250mm
	3/8"	x1	125mm
	1/4"	x2	50, 100mm
	1/2"	x1	8mm
	3/8"	x1	8mm
	1/4"	x1	6mm
	1/4"	x1	6mm

	x3	1/2", 3/8", 1/4"
	1/2"	x1 adaptador 3/8" H x 1/2" M
	1/2"	x2 16, 21mm
	3/8"	x1 18mm
	1/2"	x12 8, 9, 10, 11, 12, 13, 14, 15, 16, 17, 18, 19mm
	1/2"	x7 1.27, 1.5, 2, 2.5, 3, 4, 5mm
	1/4"	x1
	1/4"	x1
	1/4"	x1
	1/2"	x1 T70
	1/2"	x1 14mm
	x3	PH0, PH1, PH2
	x3	PZ0, PZ1, PZ2
	x4	3, 4, 5, 6mm
	1/4"	x4 SL4, SL5.5, SL6.5, SL7
	x8	T8, T9, T10, T15, T20, T25, T27, T30
	x8	T8, T9, T10, T15, T20, T25, T27, T30

	8mm	x4	7, 8, 10, 12mm
	6mm	x6	2, 2.5, 3, 4, 5, 6mm
	8mm	x3	SL8, SL10, SL12
	8mm	x3	PH2, PH3, PH4
	8mm	x3	PZ2, PZ3, PZ4
	8mm	x5	T40, T45, T50, T55, T60
	6mm	x3	T5, T6, T7
	8mm	x5	T40, T45, T50, T55, T60
	6mm	x1	T7
	8mm	x4	M10, M11, M12, M13
	6mm	x5	M5, M6, M7, M8, M9
	8mm	x2	M10, M12
	6mm	x3	M5, M6, M8
	8mm	x1	TS50
	6mm	x8	TS10, TS15, TS20, TS25, TS27, TS30, TS40, TS45
		x4	0, 1, 2, 3mm
		x3	6, 8, 10mm
	6mm	x4	4, 6, 8, 10mm
		x3	1, 2, 3mm
		x4	1, 2, 3, 4mm

CONJUNTOS DE FERRAMENTAS

CAIXA DE FERRAMENTAS DE 216 PEÇAS COM CHAVES DE 12 FACES

REF.	1/4"	3/8"	1/2"	PCS	PERFIL	ACABADO					€
54250	•	•	•	216		Zincado	11.50	-	2	48	188,00€

54250



REPOSIÇÕES
DISPONÍVEIS



	1/2"	x14	13, 14, 15, 16, 17, 18, 19, 20, 21, 22, 24, 27, 30, 32mm
	3/8"	x10	10, 11, 12, 13, 14, 15, 16, 17, 18, 19mm
	1/4"	x13	4, 4.5, 5, 5.5, 6, 7, 8, 9, 10, 11, 12, 13, 14mm
	1/2"	x5	16, 17, 18, 19, 22mm
	3/8"	x6	10, 11, 12, 13, 14, 15mm
	1/4"	x7	4, 5, 6, 7, 8, 9, 10mm
	1/2"	x3	E20, E22, E24
	3/8"	x6	E10, E11, E12, E14, E16, E18
	1/4"	x5	E4, E5, E6, E7, E8
	1/2"	x3	1/2", 3/8", 1/4"
	1/2"	x2	125, 250mm
	3/8"	x1	125mm
	1/4"	x2	50, 100mm
	1/2"	x1	8mm
	3/8"	x1	8mm
	1/4"	x1	6mm
	1/4"	x1	6mm

	x3	1/2", 3/8", 1/4"
	1/2"	x1 adaptador 3/8" H x 1/2" M
	1/2"	x2 16, 21mm
	3/8"	x1 18mm
	1/2"	x12 8, 9, 10, 11, 12, 13, 14, 15, 16, 17, 18, 19mm
	1/2"	x7 1.27, 1.5, 2, 2.5, 3, 4, 5mm
	1/4"	x1
	1/4"	x1
	1/4"	x1
	1/2"	x1 T70
	1/2"	x1 14mm
	x3	PH0, PH1, PH2
	x3	PZ0, PZ1, PZ2
	x4	3, 4, 5, 6mm
	1/4"	x4 SL4, SL5.5, SL6.5, SL7
	x8	T8, T9, T10, T15, T20, T25, T27, T30
	x8	T8, T9, T10, T15, T20, T25, T27, T30

	8mm	x4	7, 8, 10, 12mm
	6mm	x6	2, 2.5, 3, 4, 5, 6mm
	8mm	x3	SL8, SL10, SL12
	8mm	x3	PH2, PH3, PH4
	8mm	x3	PZ2, PZ3, PZ4
	8mm	x5	T40, T45, T50, T55, T60
	6mm	x3	T5, T6, T7
	8mm	x5	T40, T45, T50, T55, T60
	6mm	x1	T7
	8mm	x4	M10, M11, M12, M13
	6mm	x5	M5, M6, M7, M8, M9
	8mm	x2	M10, M12
	6mm	x3	M5, M6, M8
	8mm	x1	TS50
	6mm	x8	TS10, TS15, TS20, TS25, TS27, TS30, TS40, TS45
		x4	0, 1, 2, 3mm
		x3	6, 8, 10mm
	6mm	x4	4, 6, 8, 10mm
		x3	1, 2, 3mm
		x4	1, 2, 3, 4mm

CONJUNTOS DE FERRAMENTAS

CAIXA DE FERRAMENTAS DE 179 PEÇAS COM CHAVES HEXAGONAIS

REF.	1/4"	3/8"	1/2"	PCS	PERFIL	ACABADO					€
54035	•	•	•	179		Zincado	9.00	-	2	56	149,00€
54046	•	•	•	179		Cromado	9.00	-	2	56	150,00€

54035



REPOSIÇÕES DISPONÍVEIS

54046



REPOSIÇÕES DISPONÍVEIS



	1/2" x17	10, 11, 12, 13, 14, 15, 16, 17, 18, 19, 20, 21, 22, 24, 27, 30, 32mm
	3/8" x10	10, 11, 12, 13, 14, 15, 16, 17, 18, 19mm
	1/4" x13	4, 4.5, 5, 5.5, 6, 7, 8, 9, 10, 11, 12, 13, 14mm
	1/2" x5	16, 17, 18, 19, 22mm
	3/8" x6	10, 11, 12, 13, 14, 15mm
	1/4" x7	4, 5, 6, 7, 8, 9, 10mm
	1/2" x2	E20, E24
	3/8" x6	E10, E11, E12, E14, E16, E18
	1/4" x5	E4, E5, E6, E7, E8
	3/8" x3	1/2", 3/8", 1/4"
	1/2" x2	125, 250mm
	3/8" x1	125mm
	1/4" x2	50, 100mm
	3/8" x3	1/2", 3/8", 1/4"

	1/2" x2	16, 21mm
	3/8" x1	18mm
	1/2" x1	8mm
	3/8" x1	8mm
	1/4" x1	6mm
	1/2" x7	1.27, 1.5, 2, 2.5, 3, 4, 5mm
	1/4" x1	1/4"
	1/4" x1	1/4"
	3/8" x3	PH1, PH2, PH3
	3/8" x3	PZ1, PZ2, PZ3
	1/4" x5	2, 3, 4, 5, 6mm
	1/4" x3	SL4, SL5.5, SL7
	1/4" x8	T8, T9, T10, T15, T20, T25, T27, T30
	1/4" x8	T8, T9, T10, T15, T20, T25, T27, T30

	1/2" x11	T5, T6, T7, T8, T9, T10, T15, T20, T25, T27, T30
	3/8" x9	T7, T10, T15, T20, T25, T27, T30, T40, T45
	6mm x5	M5, M6, M7, M8, M9
	6mm x3	M5, M6, M8
	6mm x2	PH3, PH4
	6mm x2	PZ3, PZ4
	8mm x5	7, 8, 10, 12, 14mm
	8mm x3	SL8, SL10, SL12
	8mm x6	T40, T45, T50, T55, T60, T70
	8mm x6	T40, T45, T50, T55, T60, T70

CONJUNTOS DE FERRAMENTAS

CAIXA DE FERRAMENTAS DE 113 PEÇAS COM CHAVES DE 12 FACES

REF.	1/4"	3/8"	1/2"	PCS	PERFIL	ACABADO					€
54036	•		•	113		Zincado	7.10	-	3	108	99,00€
54047	•		•	113		Cromado	7.10	-	3	108	100,00€

54036



REPOSIÇÕES DISPONÍVEIS

54047



REPOSIÇÕES DISPONÍVEIS



	1/2"	x17	10, 11, 12, 13, 14, 15, 16, 17, 18, 19, 20, 21, 22, 24, 27, 30, 32mm
	1/4"	x13	4, 4.5, 5, 5.5, 6, 7, 8, 9, 10, 11, 12, 13, 14mm
	1/2"	x5	14, 15, 17, 19, 22mm
	1/4"	x8	6, 7, 8, 9, 10, 11, 12, 13mm
	1/2"	x8	E10, E11, E12, E14, E16, E18, E20, E24
	1/4"	x5	E4, E5, E6, E7, E8
	7/32"	x2	1/2", 1/4"
	1/2"	x2	125, 250mm
	1/4"	x2	50, 100mm

	x2	1/2", 1/4"
	1/2"	x1 adaptador 3/8" H x 1/2" M
	1/2"	x1 8mm
	x5	7, 8, 10, 12, 14mm
	x3	SL8, SL10, SL12
	x2	PH3, PH4
8mm	x2	PZ3, PZ4
	x5	T40, T45, T50, T55, T60
	x5	5, 6, 8, 10, 12mm

	1/2"	x2	16, 21mm
	x3	1.5, 2, 2.5mm	
	x1	1/4"	
	x1	1/4"	
	x2	PH1, PH2	
	x2	PZ1, PZ2	
	1/4"	x4	3, 4, 5, 6mm
	x3	SL4, SL5.5, SL6.5	
	x7	T8, T10, T15, T20, T25, T27, T30	

CONJUNTOS DE FERRAMENTAS

CAIXA DE FERRAMENTAS DE 108 PEÇAS COM CHAVES HEXAGONAIS

REF.	1/4"	3/8"	1/2"	PCS	PERFIL	ACABADO					€
54037	•		•	108		Zincado	6.58	-	3	108	88,00€
54048	•		•	108		Cromado	7.10	-	3	108	89,00€

54037



REPOSIÇÕES DISPONÍVEIS

54048



REPOSIÇÕES DISPONÍVEIS



	1/2" x17	10, 11, 12, 13, 14, 15, 16, 17, 18, 19, 20, 21, 22, 24, 27, 30, 32mm
	1/4" x13	4, 4.5, 5, 5.5, 6, 7, 8, 9, 10, 11, 12, 13, 14mm
	1/2" x5	14, 15, 17, 19, 22mm
	1/4" x8	6, 7, 8, 9, 10, 11, 12, 13mm
	1/2" x8	E10, E11, E12, E14, E16, E18, E20, E24
	1/4" x5	E4, E5, E6, E7, E8
	1/2" x2	1/2", 1/4"
	1/2" x2	125, 250mm
	1/4" x2	50, 100mm
	1/2" x2	1/2", 1/4"
	1/2" x1	adaptador 3/8" H x 1/2" M

	1/2" x2	16, 21mm
	1/2" x1	8mm
	1/2" x3	1.5, 2, 2.5mm
	1/4" x1	1/4"
	1/4" x1	1/4"
	1/2" x2	PH3, PH4
	1/2" x2	PZ3, PZ4
	8mm x5	7, 8, 10, 12, 14mm
	1/4" x3	SL8, SL10, SL12
	1/2" x5	T40, T45, T50, T55, T60

	1/4" x2	PH1, PH2
	1/4" x2	PZ1, PZ2
	1/4" x4	3, 4, 5, 6mm
	1/4" x3	SL4, SL5.5, SL6.5
	1/4" x7	T8, T10, T15, T20, T25, T27, T30

DIVIDA OS ESTOJOS EM DUAS PARTES, ADAPTANDO-OS À TAREFA DE QUE NECESSITA

Estes casos, concebidos para otimizar a produtividade, podem ser facilmente divididos em duas partes, adaptando-se ao seu local de trabalho e tornando o trabalho mais eficiente.



CONJUNTOS DE FERRAMENTAS

CAIXA DE FERRAMENTAS DE 94 PEÇAS COM CHAVES HEXAGONAIS

REF.	1/4"	3/8"	1/2"	PCS	PERFIL	ACABADO					€
54038	•		•	94		Zincado	6.50	-	3	108	88,00€
54049	•		•	94		Cromado	6.50	-	3	108	89,00€

54038



REPOSIÇÕES DISPONÍVEIS

54049



REPOSIÇÕES DISPONÍVEIS



	1/2"	x18	10, 11, 12, 13, 14, 15, 16, 17, 18, 19, 20, 21, 22, 23, 24, 27, 30, 32mm
	1/4"	x13	4, 4.5, 5, 5.5, 6, 7, 8, 9, 10, 11, 12, 13, 14mm
	1/2"	x4	14, 15, 17, 19mm
	1/4"	x8	6, 7, 8, 9, 10, 11, 12, 13mm
		x2	1/2", 1/4"
	1/2"	x2	125, 250mm
	1/4"	x2	50, 100mm
		x2	1/2", 1/4"
	1/2"	x1	adaptador 3/8" H x 1/2" M

	1/2"	x1	8mm
		x3	1.5, 2, 2.5mm
	1/2"	x2	16, 21mm
		x2	PH3, PH4
		x2	PZ3, PZ4
	8mm	x4	8, 10, 12, 14mm
		x3	SL8, SL10, SL12
		x4	T40, T45, T50, T55
	1/4"	x1	8mm

		x1	1/4"
		x1	1/4"
		x1	1/4"
		x2	PH1, PH2
		x2	PZ1, PZ2
	1/4"	x4	3, 4, 5, 6mm
		x3	SL4, SL5.5, SL7
		x6	T8, T10, T15, T20, T25, T30

ESTOJOS DIVISÍVEIS PARA OTIMIZAR O FLUXO DE TRABALHO E MELHORAR A ORGANIZAÇÃO

Devido à sua estrutura divisível, que permite separar as duas peças centrais em duas partes, estes estojos foram concebidos para serem facilmente armazenados nos nossos carrinhos de ferramentas.



CONJUNTOS DE FERRAMENTAS

CAIXA DE FERRAMENTAS DE 302 PEÇAS COM CHAVES HEXAGONAIS

REF.	1/4"	3/8"	1/2"	PCS	PERFIL	ACABADO					€
53212	•		•	302		Zincado	9,45	-	2	48	174,00€

53212



REPOSIÇÕES DISPONÍVEIS



	x18	10, 11, 12, 13, 14, 15, 16, 17, 18, 19, 20, 21, 22, 23, 24, 27, 30, 32mm
	x2	125, 250mm
	x2	16, 21mm
	1/2"	x1 8mm
	x1	adaptador 3/8" H x 1/2" M
	x1	UNIVERSAL
	x1	
	x13	4, 4.5, 5, 5.5, 6, 7, 8, 9, 10, 11, 12, 13, 14mm
	x2	50, 100mm
	x1	6,3mm
	1/4"	x1
	x1	UNIVERSAL
	x1	
	x8	T25, T27, T30, T35, T40 (x2), T45, T50
	x2	PH3, PH4
	x2	PZ3, PZ4
	x4	H5.5, H6.5, H7, H8
	x4	5.5, 6.5, 7, 8mm
	x4	5, 6, 8, 10mm

	x9	3, 4, 4.5, 5, 5.5, 6, 6.5, 7, 8mm
	x9	T8, T10, T15, T20, T25, T27, T30, T35, T40
	x9	H1.5, H2, H2.5, H3, H.4, H5, H5.5, H6, H8
	x3	5, 6, 8mm
	x4	1, 2, 3, 4
	x3	6, 8, 10
	x3	C1, C2, C3
	x6	2, 2.5, 3, 4, 5, 6mm
	x4	S0, S1, S2, S3
	x6	5/64, 3/32, 7/64, 1/8, 9/64, 5/32
	x4	4, 6, 8, 10mm
	x10	PH0 (x2), PH1 (x2), PH2 (x4), PH3 (x2)
	x10	PZ0 (x2), PZ1 (x2), PZ2 (x4), Z3 (x2)
	x10	1/16, 5/64, 3/32, 7/64, 1/8, 9/64, 5/32, 3/16, 7/32, 1/4
	x10	T8, T10, T15, T20, T25, T27, T30, T35, T40, T45
	x6	1.5, 2, 2.5, 3, 3.5, 4mm
	x4	PH000, PH00, PH0, PH1
	x2	PZ0, PZ1
	x8	T5, T6, T7, T8, T9, T10, T15, T20

	x1		x1	300g
	x1		x1	
	x10		x1	
	x1		x23	
	x1	3m	x22	
	x1		x10	
	x1	8"	x10	
	x2	0.4x2.5, 0.5x3.0x50mm		
	x3	PH0x50, PH00x50, PH000x50mm		
	x2	0.8x4x100, 1.2x6.5x125mm		
	x2	PH1x80, PH2x100mm		
	x7	1.27, 1.5, 2, 2.5, 3, 4, 5mm		
	x13	1.5, 2, 2.5, 3, 3.2, 3.5, 4, 4.5, 4.8, 5, 5.5, 6, 6.5mm		

CONJUNTOS DE FERRAMENTAS

CAIXA DE FERRAMENTAS DE 132 PEÇAS COM CHAVES HEXAGONAIS

REF.	1/4"	3/8"	1/2"	PCS	PERFIL	ACABADO					€
54082	•	•	•	132		Zincado	11.00	-	2	56	189,00€

54082



REPOSIÇÕES DISPONÍVEIS



	1/2"	x7	19, 21, 22, 24, 27, 30, 32mm
	3/8"	x12	8, 9, 10, 11, 12, 13, 14, 15, 16, 17, 18, 19mm
	1/4"	x11	4, 5, 5.5, 6, 7, 8, 9, 10, 11, 12, 13mm
	3/8"	x4	13, 14, 15, 17mm
	1/4"	x4	8, 10, 12, 13mm
	3/8"	x6	E8, E10, E11, E14, E16, E20
	1/2"	x1	
	3/8"	x1	
	1/4"	x1	
	1/2"	x2	127, 254mm
	3/8"	x2	76, 152mm
	1/4"	x1	50mm
		x1	Ø14mm
		x1	

		x1	3/8"(H) - 1/2"(M)
		x1	3/8"(H) - 1/2"(M)
		x1	3/8"(H) - 1/4"(M)
	1/2"	x1	
	3/8"	x1	
	1/4"	x1	
	1/2"	x3	17, 19, 21mm
	1/4"	x1	6mm
		x1	
		x1	PH2x100
		x1	SL6x100
		x12	8, 9, 10, 11, 12, 13, 14, 15, 16, 17, 18, 19mm
		x1	
	1/2"	x1	H17
		x1	

	1/2"	x1	21mm
	3/8"	x2	16, 18mm
	1/2"	x1	T52
	1/2"	x1	M16
		x2	5.5, 6.5mm
		x2	PH1, PH3
	3/8"	x2	PZ1, PZ3
		x4	4, 5, 6, 8mm
		x6	T20, T30, T40, T45, T50, T55
		x3	4, 5, 6.5mm
		x3	PH1, PH2, PH3
	6mm	x3	PZ1, PZ2, PZ3
		x4	3, 4, 5, 6
		x7	T10, T15, T20, T25, T27, T30, T40
		x9	1.5, 2, 2.5, 3, 4, 5, 6, 8, 10mm

53074

78,00€

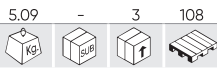

MALA DE FERRAMENTAS DE 74 PEÇAS COM CHAVES DE 12 GUMES, ZINCADA



REPOSIÇÕES DISPONÍVEIS



	1/2"	x18	10, 11, 12, 13, 14, 15, 16, 17, 18, 19, 20, 21, 22, 23, 24, 27, 30, 32mm
	1/4"	x10	4, 5, 5.5, 6, 7, 8, 10, 11, 12, 13mm
		x2	1/2", 1/4"
	1/2"	x2	125, 250mm
	1/4"	x1	100mm
		x5	PH0, PH1, PH2, PH3, PH4
		x5	PZ0, PZ1, PZ2, PZ3, PZ4
		x6	3, 4, 5, 6, 8, 10mm
	6mm	x5	SL3, SL4, SL5.5, SL6, SL7
		x8	T8, T10, T15, T20, T25, T27, T30, T40
		x4	4, 5, 6, 7mm
	1/2"	x1	
	1/2"	x1	21mm
	1/2"	x1	
	1/4"	x1	6mm
		x3	1.5, 2, 2.5mm
	1/4"	x1	

54140

36,00€



KIT DE FERRAMENTAS DE 56 PEÇAS COM SOQUETES DE 12 GUMES ZINCADOS



REPOSIÇÕES DISPONÍVEIS



	x13	4, 4.5, 5, 5.5, 6, 7, 8, 9, 10, 11, 12, 13, 14mm		x1		
	x1			x1		
	1/4"	x2	50, 100mm		1/4"	x1
	x1					x1
	x4	SL4, SL5, SL6, SL7				
	x3	M5, M6, M8				
	x8	T8, T10, T15, T20, T25, T27, T30, T40				
	CR-V 25 L	x8	T8, T10, T15, T20, T25, T27, T30, T40			
	x3	PH0, PH1, PH2				
	x3	PZ0, PZ1, PZ2				
	x6	3, 4, 5, 6, 7, 8mm				

54108

66,00€



CAIXA DE FERRAMENTAS 22 PÇS. DE CHAVES HEXAGONAIS DE 1/2" ZINCADÁS



REPOSIÇÕES DISPONÍVEIS



	1/2"	x17	10, 11, 12, 13, 14, 15, 16, 17, 18, 19, 21, 22, 24, 27, 30, 32mm
		x1	1/2"
	1/2"	x2	125, 250mm
	x1	1/2"	
	x1	3/8"(H) - 1/2"(M)	

54116

66,00€



CAIXA DE FERRAMENTAS 22 PÇS. DE SOQUETES DE 12 ARESTAS 1/2" ZINCADO



REPOSIÇÕES DISPONÍVEIS



	1/2"	x17	10, 11, 12, 13, 14, 15, 16, 17, 18, 19, 21, 22, 24, 27, 30, 32mm
		x1	1/2"
	1/2"	x2	125, 250mm
	x1	1/2"	
	x1	3/8"(H) - 1/2"(M)	

54106

89,00€

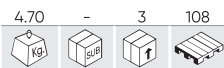

CAIXA DE FERRAMENTAS EM POLEGADAS ZINCADA COM 36 PEÇAS



REPOSIÇÕES DISPONÍVEIS



	x17	5/16", 3/8", 7/16", 1/2", 9/16", 19/32", 5/8", 11/16", 3/4", 13/16", 7/8", 15/16", 1", 1-1/16", 1-1/8", 1-3/16", 1-1/4"		x8	3/16", 7/32", 1/4", 9/32", 5/16", 11/32", 3/8", 7/16"
	x1		x1		
	x1	1/2" 10" (250mm)		x1	1/4" 3" (75mm)
	x1	5" (125mm)		x1	4,5" (115mm)
	x2	13/16", 5/8"		x1	6" (150mm)
	x1	UNIVERSAL		x1	UNIVERSAL

54258

58,00€

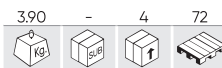

CONJUNTO DE FERRAMENTAS ZINCADO DE 77 PEÇAS



	x5	PH0, PH1, PH2, PH2, PH3		x1
	x5	PZ0, PZ1, PZ2, PZ2, PZ3		x1
	x5	SL3, SL4, SL5, SL5.5, SL6mm		x1
	x5	T10, T15, T20, T25, T30		x1
	x4	6x7, 8x9, 10x11, 12x13mm		x1
	x9	1.5, 2, 2.5, 3, 4, 5, 6, 8, 10mm		x1
	x3	PH2x100, PH00x50, PH000x50		x1
	x3	SL6x100, SL2.5x50, SL3.0x50		x10
	x1			x10
	x10			

51818

109,00€

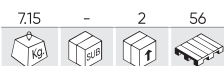

MALA DE FERRAMENTAS DE 72 PEÇAS COM CHAVES HEXAGONAIS ZINCADAS

	1/2"	x13	10, 11, 12, 13, 14, 15, 17, 19, 22, 24, 27, 30, 32mm
	1/4"	x10	4, 5, 6, 7, 8, 9, 10, 11, 12, 13mm
	1/4"	x5	5, 6, 7, 8, 9mm
		x1	1/2"
		x1	1/4"
		x1	125mm
		x1	75mm
		x2	1/2", 1/4"
		x2	16, 21mm
		x1	6mm
		x8	10, 11, 12, 13, 14, 15, 17, 19mm
		x3	1.5, 2, 2.5mm
		x1	1/4"
		x2	PH2x100, PH1x40mm
		x3	8x200, 6x100, 6x40mm
		x1	



REPOSIÇÕES DISPONÍVEIS

	x1	300gr
	x1	
	x1	
	x4	SL3, SL4, SL5, SL6
	x3	PH1, PH2, PH3
	x7	T10, T15, T20, T25, T27, T30, T40

54277

53,50€

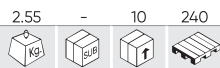

CAIXA DE FERRAMENTAS 3/8" DE 59 PEÇAS COM CHAVES HEXAGONAIS ZINCADAS



REPOSIÇÕES DISPONÍVEIS



3/8" x17 6, 7, 8, 9, 10, 11, 12, 13, 14, 15, 16, 17, 18, 19, 20, 21, 22mm	3/8" x1 8mm
x2 PH1, PH2	x2 PH3, PH4
x2 PZ1, PZ2	x2 PZ3, PZ4
1/4" x4 3, 4, 5, 6mm	8mm x5 7, 8, 10, 12, 14mm
x3 SL4, SL5.5, SL6.5	x3 SL8, SL10, SL12
x7 T8, T10, T15, T20, T25, T27, T30	x5 T40, T45, T50, T55, T60
3/8" x1	3/8" x1 8mm
3/8" x2 75, 150mm	3/8" x1
3/8" x1 8mm	1/4" x1

54109

34,00€

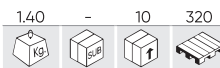

CONJUNTO DE 46 PEÇAS COM ENCAIXES HEXAGONAIS ZINCADOS



REPOSIÇÕES DISPONÍVEIS



1/4" x13 4, 4.5, 5, 5.5, 6, 7, 8, 9, 10, 11, 12, 13, 14mm	1/4" x1	1/4" x1
1/4" x1	x1 UNIVERSAL	
1/4" x1	x4 1.27, 1.5, 2.0, 2.5mm	
1/4" x2 50, 100mm	x1	
x3 SL4, SL5.5, SL7	x6 H3, H4, H5, H6, H7, H8	
1/4" x3 PH1, PH2, PH3	x6 T10, T15, T20, T25, T30, T40	
x3 PZ1, PZ2, PZ3		

54168

49,00€

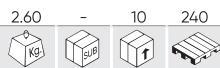

KIT DE FERRAMENTAS DE 59 PEÇAS DE 3/8" COM CHAVES DE 12 PONTAS ZINCADAS



REPOSIÇÕES DISPONÍVEIS



3/8" x17 6, 7, 8, 9, 10, 11, 12, 13, 14, 15, 16, 17, 18, 19, 20, 21, 22mm	3/8" x1 8mm
3/8" x1	3/8" x1
3/8" x2 75, 150mm	3/8" x1
3/8" x1 8mm	1/4" x1
x2 PH3, PH4	x2 PH1, PH2
x2 PZ3, PZ4	x2 PZ1, PZ2
8mm x5 7, 8, 10, 12, 14mm	1/4" x4 3, 4, 5, 6mm
x3 8, 10, 12mm	x3 4, 5.5, 6.5mm
x5 T40, T45, T50, T55, T60	x7 T8, T10, T15, T20, T25, T27, T30

54105

33,00€

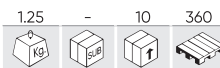

KIT DE FERRAMENTAS DE 56 PEÇAS DE 1/4" COM CHAVES DE 12 PONTAS ZINCADAS



REPOSIÇÕES DISPONÍVEIS



x4 SL4, SL5, SL6, SL7	1/4" x1
x3 M5, M6, M8	1/4" x2 50, 100mm
x8 T8, T10, T15, T20, T25, T27, T30, T40	1/4" x1
6mm x8 T8, T10, T15, T20, T25, T27, T30, T40	1/4" x1
x3 PH0, PH1, PH2	1/4" x1
x3 PZ0, PZ1, PZ2	1/4" x1
x6 3, 4, 5, 6, 7, 8mm	1/4" x13 4, 4.5, 5, 5.5, 6, 7, 8, 9, 10, 11, 12, 13, 14mm
1/4" x1 6mm	

52418

189,00€

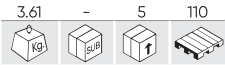

CAIXA DE FERRAMENTAS DE PASSAGEM COM 39 PEÇAS CROMADA



	13mm	x12	4, 4.5, 5, 5.5, 6, 7, 8, 9, 10, 11, 12, 13mm
	19mm	x10	10, 11, 12, 13, 14, 15, 16, 17, 18, 19mm
	22mm	x5	20, 21, 22, 23, 24mm
	22mm	x3	27, 30, 32mm
	13mm	x3	13, 19, 22mm
	13mm	x3	13, 19, 22mm
	1/4"	x1	13mm
	3/8"	x1	19mm
	1/2"	x1	22mm

50623

64,00€

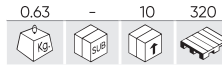

KIT DE FERRAMENTAS GO-THROUGH DE 16 PEÇAS - CROMADO



	4, 4.5, 5, 5.5, 6, 7, 8, 9, 10, 11, 12, 13, 14mm	x13	4, 4.5, 5, 5.5, 6, 7, 8, 9, 10, 11, 12, 13, 14mm
	75mm	x1	75mm
	1/4"	x1	1/4"
	145mm	x1	145mm

54090

56,00€

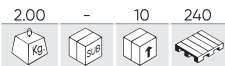

KIT DE FERRAMENTAS GO-THROUGH DE 14 PEÇAS - ZINCADO



VÍDEO TUTORIAL



REPOSIÇÕES DISPONÍVEIS



	13, 14, 15, 16, 17, 18, 19, 21, 22, 24, 27mm	x11	13, 14, 15, 16, 17, 18, 19, 21, 22, 24, 27mm
	75mm	x1	75mm
	1/2"	x1	1/2"
	255mm	x1	255mm

ESTOJOS CONCEBIDOS PARA FACILITAR OS TRABALHOS DE APERTO E DESAPERTO

A característica do sistema "GO-THROUGH" é o seu design de passagem, o que significa que permite trabalhar com parafusos ou cavilhas salientes - algo que as ferramentas tradicionais não conseguem fazer devido à limitação de profundidade da chave



53915

69,00€

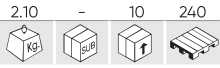

CONJUNTO DE 6 CHAVES DE CAIXA 1/2" TORX TIPO E EXTRA LONGAS ZINCADAS



		1/2"	x6	140mm	E10, E12, E14, E16, E18, E20
--	--	------	----	-------	------------------------------

E12 Soquete para cabeça do bloco de cilindros BMW:
 - Motor M42, 1,8 L, 4 cilindros, 16 V, modelo 318 (1989)
 - Motor M50, 2.0L, 2.5L, 6 cilindros, 24V, modelos 520i, 525i (1991)

54141

42,00€

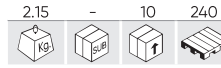

JOGO 28 CHAVES TORX CURTAS E LONGAS ZINCADAS



REPOSIÇÕES DISPONÍVEIS

		1/4"	x5 (25mm)	E4, E5, E6, E7, E8
		3/8"	x5 (28mm)	E10, E11, E12, E14, E16
		1/2"	x4 (38mm)	E18, E20, E22, E24
		1/4"	x5 (50mm)	E4, E5, E6, E7, E8
		3/8"	x5 (63mm)	E10, E11, E12, E14, E16
		1/2"	x4 (76mm)	E18, E20, E22, E24

53953

29,00€

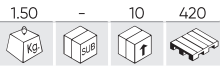

JOGO DE SOQUETES E BITS 130 PCS. ZINCADO

		25mm	x10	1/16, 5/64, 3/32, 7/64, 1/8, 9/64, 5/32, 3/16, 7/32, 1/4
			x9	1.5, 2, 2.5, 3, 4, 5, 5.5, 6, 8mm
		25mm	x6	5/64, 3/32, 7/64, 1/8, 9/64, 5/32
			x6	2, 2.5, 3, 4, 5, 6mm
		25mm	x9	3, 4, 4.5, 5, 5.5, 6, 6.5, 7, 8mm
		50mm	x2	4, 6mm
		25mm	x10	PH0(x2), PH1(x2), PH2(x4), PH3(x2)
		50mm	x2	PH1, PH2
		25mm	x10	PZ0(x2), PZ1(x2), PZ2(x4), PZ3(x2)
		25mm	x10	T8, T10, T15, T20, T25, T27, T30, T35, T40, T45
		25mm	x9	T8, T10, T15, T20, T25, T27, T30, T35, T40
		25mm	x3	M5, M6, M8
		25mm	x3	6, 8, 10mm
		25mm	x3	C1, C2, C3
		25mm	x4	1, 2, 3, 4mm
		25mm	x4	4, 6, 8, 10mm
		25mm	x4	0, 1, 2, 3mm



REPOSIÇÕES DISPONÍVEIS

		1/4"	x13	4, 4.5, 5, 5.5, 6, 7, 8, 9, 10, 11, 12, 13, 14mm
		1/4"	x1	1/4"
		1/4"	x1	50mm
		1/4"	x1	1/4"
		1/4"	x1	6mm
		1/4"	x1	1/4"
		1/4"	x7	1.27, 1.5, 2, 2.5, 3, 4, 5mm

CAIXA DE FERRAMENTAS 60 PEÇAS CHAVES ESTRIADAS DE 1/2" E 1/4"

REF.	1/4"	3/8"	1/2"	1"	PCS	Perfil	Acabado					€
52722	•		•		60		Zincado	4.63	-	4	60	87,00€
53108	•		•		60		Cromado	4.83	-	3	90	92,00€

52722



REPOSIÇÕES DISPONÍVEIS



53108



REPOSIÇÕES DISPONÍVEIS



	1/2"	x11	14, 15, 16, 17, 18, 19, 22, 24, 27, 30, 32mm
	1/4"	x12	4, 4.5, 5, 5.5, 6, 7, 8, 9, 10, 11, 12, 13mm
		x2	1/2", 1/4"
	1/2"	x2	5", 10"
	1/4"	x2	2", 4"
		x2	1/2", 1/4"
		x1	

	1/2"	x2	16, 21mm
		x1	25mm
		x3	1.5, 2, 2.5mm
		x1	1/4"
		x1	1/4"
		x1	AD

		x3	PH1, PH2, PH3
		x3	PZ1, PZ2, PZ3
	25mm	x5	3, 4, 5, 6, 8mm
		x3	SL4, SL5.5, SL7
		x5	T10, T15, T20, T25, T30

CAIXA METÁLICA COM 21 PEÇAS DE AUTOCLAVE ZINCADO DE 1"

REF.	1/4"	3/8"	1/2"	1"	PCS	Perfil	Acabado					€
51616				•	21		Zincado	34.60	-	1	24	378,00€
51855				•	21		Zincado	33.70	-	1	24	378,00€

51616



REPOSIÇÕES DISPONÍVEIS



51855



REPOSIÇÕES DISPONÍVEIS



	1"	x17	36, 38, 41, 46, 50, 54, 55, 58, 60, 63, 65, 67, 70, 71, 75, 77, 80mm
	1"	x1	650mm
	1"	x2	205, 410mm
	1"	x1	

CAIXA DE FERRAMENTAS COM 21 PEÇAS DE 3/4" ZINCADO

REF.	1/4"	3/8"	1/2"	3/4"	PCS	Perfil	Acabado					€
53727				•	21		Zincado	14.65	-	1	48	198,00€
53728				•	21		Zincado	14.30	-	1	48	198,00€

53727



REPOSIÇÕES DISPONÍVEIS



53728



REPOSIÇÕES DISPONÍVEIS



		3/4"	x16	19, 21, 22, 23, 24, 26, 27, 29, 30, 32, 35, 36, 38, 41, 46, 50mm
		3/4"	x1	495mm
		3/4"	x3	100, 200, 400mm
		3/4"	x1	445mm

53565

258,00€

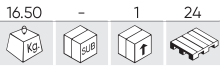

CAIXA DE FERRAMENTAS EM FERRO 63 PEÇAS ZINCADA



REPOSIÇÕES DISPONÍVEIS



		1/2"	x18	10, 11, 12, 13, 14, 15, 16, 17, 18, 19, 20, 21, 22, 23, 24, 27, 30, 32mm
			x1	1/2"
			x1	1/2"
		1/2"	x3	76, 127, 254mm
		1/2"	x1	255mm
		1/2"	x1	21mm
			x1	457mm
			x18	6, 7, 8, 9, 10, 11, 12, 13, 14, 15, 16, 17, 18, 19, 20, 21, 22, 24mm

			x9	1.5, 2, 2.5, 3, 4, 5, 6, 8, 10mm
			x3	PH1x100, PH2x150, H3x200mm
			x3	SL5x100, SL6x150, SL8x200mm
			x1	250mm
			x1	200mm
			x1	180mm
			x1	180mm

54261

321,00€

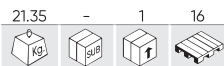

CAIXA METÁLICA COM FERRAMENTAS 143 PEÇAS ZINCADA



VÍDEO TUTORIAL



REPOSIÇÕES DISPONÍVEIS



	x13	4, 4.5, 5, 5.5, 6, 7, 8, 9, 10, 11, 12, 13, 14mm
	x6	8, 10, 11, 12, 13, 14mm
	x7	E4, E5, E6, E7, E8, E10, E11
	x2	2", 4"
	x1	110mmL
	1/4"	x1
	x1	150mmL
	x3	PH1, PH2, PH3
	x3	SL4, SL5.5, SL6.5
	x6	TT10, TT15, TT20, TT25, TT30, TT40
	x6	H3, H4, H5, H6, H7, H8
	x1	
	x1	250mm

	x20	8, 9, 10, 11, 12, 13, 14, 15, 16, 17, 18, 19, 20, 21, 22, 23, 24, 27, 30, 32mm
	x2	5", 10"
	1/2"	x2
	x2	16, 21mm
	x1	UNIVERSAL
	x1	3/8"(F) - 1/2"(M)
	1/2"	x2
	1/4"	x2
	x12	6, 7, 8, 9, 10, 11, 12, 13, 14, 17, 19, 22mm
	x8	6x7, 8x9, 10x11, 12x13, 14x15, 16x17, 18x19, 20x22mm
	x1	7" - 180mm
	x1	8" - 200mm
	x4	SL5x75, SL6x100, SL8x150, SL10x200mmL
	x3	PH1x80, PH2x100, PH3x150mmL

	x4	PH1, PH2(x2), PH3
	x4	PZ1, PZ2(x2), PZ3
	x4	SL3, SL4, SL5, SL6
	x4	H3, H4, H5, H6
	x7	TT10, TT15, TT20, TT25, TT27, T30, T40
	x7	TT10, TT15, TT20, TT25, TT27, TT30, TT40
	x1	1/4"
	x1	6.35mmx60mmL
	x1	1/4" - 6.35mm
	x1	7" - 180mm
	x1	10" - 250mm



53159



CAIXA DE FERRAMENTAS EM ALUMÍNIO 159 PEÇAS ZINCADA



REPOSIÇÕES DISPONÍVEIS



	1/2" x14	14, 15, 16, 17, 18, 19, 20, 21, 22, 23, 24, 27, 30, 32mm
	1/4" x10	4, 5, 6, 7, 8, 9, 10, 11, 12, 13mm
	x2	1/4", 1/2"
	1/2" x2	50, 100mm
	1/4" x2	125, 250mm
	1/4" x1	150mm
	x2	1/4", 1/2"
	1/2" x1	
	x2	1/4", 1/2"
	1/4" x1	250mm
	1/4" x1	110mm
	1/2" x2	16, 21mm
	x9	8, 10, 11, 12, 13, 15, 17, 19, 22mm
	x9	1.5, 2, 2.5, 3, 4, 5, 6, 8, 10mm
	x1	100-250V
	x1	
	x2	PH1x80, PH2x10mm
	x4	SL3x75, SL4x100, SL6.5x125, SL8x150mm
	x1	PH00x50mm
	x1	SL2.5x50mm
	x1	250mm
	x1	160mm
	x1	180mm
	x1	160mm
	x1	200mm
	x1	180mm
	x1	220mm
	x1	160mm
	x5	
	x1	18mm
	x10	
	x1	300gr
	x40	6.35mm
	x15	8mm
	x1	3m
	x1	200mm
	x1	1/4"



53928

278,00€

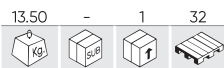

CAIXA DE FERRAMENTAS DE 135 PEÇAS COM CHAVES HEXAGONAIS ZINCADAS



REPOSIÇÕES DISPONÍVEIS



	x10	10, 11, 12, 13, 14, 15, 17, 19, 22, 24mm		x1	180mm
	x2	16, 21mm		x1	200mm
	x1	UNIVERSAL		x1	160mm
	x2	125, 250mm		x1	200mm
	x1	3/8", 1/2"		x1	18mm
	x1			x1	5m
	x9	4, 5, 6, 7, 8, 9, 10, 11, 12mm		x1	300g
	x1	UNIVERSAL		x1	6mm
	x1			x1	6mmL
	x2	50, 100mm		x1	150mm
	x1			x1	
	x1	6mm		x1	
	x9	8, 10, 11, 12, 13, 14, 17, 19, 22mm		x1	
	x4	PH1, PH2, PH2, PH3		x1	
	x4	PZ1, PZ2, PZ2, PZ3		x1	
	x4	SL3, SL4, SL5, SL6		x1	
	x4	H3, H4, H5, H6		x1	
	x7	T10, T15, T20, T25, T27, T30, T40		x1	
	x7	TT10, TT15, TT20, TT25, TT27, TT30, TT40		x1	
	x3	SL1.5, SL2, SL3		x3	
	x4	PH000, PH00, PH0, PH1		x5	
	x8	T4, T5, T6, T7, T8, T10, T15, T20			
	x4	TS0.8, TS1.2, TS1.5, TS2.0			
	x1	H2.0			
	x9	1.5, 2, 2.5, 3, 4, 5, 6, 8, 10mm			
	x2	PH1x80, PH2x100mm			
	x4	SL3.0x75, SL4.0x100, SL6.5x125, SL8x150mm			
	x1	250mm			
	x1	180mm			



53444

195,00€



CAIXA DE FERRAMENTAS EM ALUMÍNIO 108 PÇS. SOQUETES 1/2" ZINCADOS



REPOSIÇÕES DISPONÍVEIS



	x9	10, 11, 12, 13, 14, 15, 17, 18, 19mm
	x2	75, 150mm
	x1	1/2" 16mm
	x1	
	x1	
	x8	4, 4.5, 5, 5.5, 6, 7, 8, 9mm
	x1	1/4" 150mmL
	x1	6mm
	x2	PH1x80, PH2x100mm
	x4	SL3.5x75, SL4x100, SL6.5x125, SL8x150mm
	x1	PH00x50mm
	x1	SL2.5x50mm
	x1	
	x9	6x7, 8x9, 10x11, 12x13, 14x15, 16x17, 18x19, 20x22mm
	x9	1.5, 2, 2.5, 3, 4, 5, 6, 8, 10mm
	x1	
	x6	
	x1	200mm
	x1	18mm
	x10	
	x1	220mm
	x1	180mm
	x1	160mm
	x1	250mm
	x1	160mm
	x30	
	x1	
	x1	300g
	x1	3m



52603

74,00€

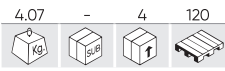

CAIXA DE PONTAS 12 FACES 26 PEÇAS



REPOSIÇÕES DISPONÍVEIS



	x8 (55mmL)	M5, M6, M8, M9, M10, M12, M14, M16
	x7 (100mmL)	M5, M6, M8, M9, M10, M12, M14
	x7 (140mmL)	M5, M6, M8, M9, M10, M12, M14
	x4 (200mmL)	M8, M10, M12, M14

52604

78,00€

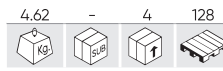

CAIXA DE PONTAS HEXAGONAIS 30 PEÇAS



REPOSIÇÕES DISPONÍVEIS



	x9 (55mmL)	5, 6, 7, 8, 10, 12, 14, 17, 19mm
	x8 (100mmL)	5, 6, 7, 8, 10, 11, 12, 13mm
	x7 (140mmL)	5, 6, 7, 8, 10, 12, 14mm
	x6 (200mmL)	5, 6, 7, 8, 10, 12mm

52605

76,00€

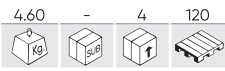

CAIXA DE PONTAS TORX 32 PEÇAS



REPOSIÇÕES DISPONÍVEIS



	x10 (55mmL)	T20, T25, T27, T30, T40, T45, T50, T55, T60, T70
	x10 (100mmL)	T20, T25, T27, T30, T40, T45, T50, T55, T60, T70
	x6 (140mmL)	T40, T45, T50, T55, T60, T70
	x6 (200mmL)	T40, T45, T50, T55, T60, T70

52606

88,00€

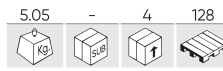

CAIXA DE PONTAS RIBE 32 PEÇAS



REPOSIÇÕES DISPONÍVEIS



	x9 (55mmL)	M5, M6, M7, M8, M9, M10, M12, M13, M14
	x9 (100mmL)	M5, M6, M7, M8, M9, M10, M12, M13, M14
	x7 (140mmL)	M7, M8, M9, M10, M12, M13, M14
	x7 (200mmL)	M7, M8, M9, M10, M12, M13, M14

54539

129,00€

4.40 - 3 90



MALETA COM SOQUETES E PONTAS TORX / TORX PLUS DE 77 PEÇAS

	1/4"	x5	E4, E5, E6, E7, E8
	3/8"	x4	E10, E12, E14, E16
	1/2"	x4	E18, E20, E22, E24
	1/4"	x5	EPL4, EPL5, EPL6, EPL7, EPL8
	3/8"	x4	EPL10, EPL12, EPL14, EPL16
	1/2"	x4	EPL18, EPL20, EPL22, EPL24
	1/4"	x8	T6, T8, T10, T15, T20, T25, T27, T30
	3/8"	x5	T40, T45, T47, T50, T55
	1/2"	x2	T60, T70
	1/4"	x7	TB8, TB10, TB15, TB20, TB25, TB27, TB30
	3/8"	x4	TB40, TB45, T50, T55
	1/2"	x1	TB60
	1/4"	x7	IP8, IP10, IP15, IP20, IP25, IP27, IP30
	3/8"	x3	IP40, IP45, IP50
	1/2"	x2	IP55, IP60
	1/4"	x7	IPR8, IPR10, IPR15, IPR20, IPR25, IPR27, IPR30
	3/8"	x3	IPR40, IPR45, IPR50
	1/2"	x2	IPR55, IPR60



REPOSIÇÕES DISPONÍVEIS

KIT DE CHAVES DE CAIXA

54266

39,50€

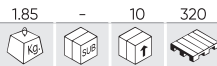

54164

34,00€

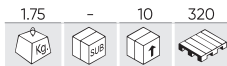

54154

37,50€

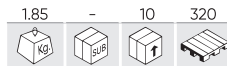

51260

37,00€

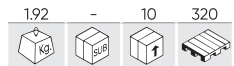

	1/2"	x9	E10, E11, E12, E14, E16, E18, E20, E22, E24
	1/2"	x10	T20, T25, T27, T30, T40, T45, T50, T55, T60, T70

	1/2"	x6	55mmL M4, M5, M6, M7, M8, M9
	1/2"	x6	70mmL M10, M12, M14, M16, M18, M20

	1/2"	x6	55mmL T20, T25, T30, T40, T45, T50
	1/2"	x6	70mmL T55, 60, T70, T80, T90, T100

	1/2"	x6	55mmL H5, H6, H7, H8, H10, H12
	1/2"	x1	65mmL H14
	1/2"	x5	70mmL H16, H17, H18, H19, H22



REPOSIÇÕES DISPONÍVEIS



REPOSIÇÕES DISPONÍVEIS



REPOSIÇÕES DISPONÍVEIS



REPOSIÇÕES DISPONÍVEIS

50983

48,00€

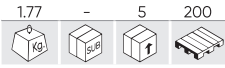

CAIXA DE 42 PEÇAS HEX, 12 CANTOS E TORX



REPOSIÇÕES DISPONÍVEIS



	3/8"	x1	10mm
	1/2"	x1	10mm
	30mm	x7	4, 5, 6, 7, 8, 10, 12mm
	75mm	x7	4, 5, 6, 7, 8, 10, 12mm
	30mm	x8	T20, T25, T30, T40, T45, T50, T55, T60
	75mm	x8	T20, T25, T30, T40, T45, T50, T55, T60
	30mm	x5	M5, M6, M8, M10, M12
	75mm	x5	M5, M6, M8, M10, M12

50985

59,00€



CAIXA DE 42 PEÇAS DE 12 E 6 CANTOS - INVOLÁVE



REPOSIÇÕES DISPONÍVEIS



	3/8"	x1	10mm
	1/2"	x1	10mm
	30mm	x7	4, 5, 6, 7, 8, 10, 12mm
	75mm	x7	4, 5, 6, 7, 8, 10, 12mm
	30mm	x8	T20, T25, T30, T40, T45, T50, T55, T60
	75mm	x8	T20, T25, T30, T40, T45, T50, T55, T60
	30mm	x5	M5, M6, M8, M10, M12
	75mm	x5	M5, M6, M8, M10, M12

52550

92,00€



CAIXA DE PONTAS 75 PEÇAS HEXAGONAIS, XZN, RIBE, TORX E TORX ÍNV.



REPOSIÇÕES DISPONÍVEIS



	3/8"	x1	10mm
	1/2"	x2	10mm
	30mm	x7	4, 5, 6, 7, 8, 10, 12mm
	75mm	x7	4, 5, 6, 7, 8, 10, 12mm
	30mm	x8	T20, T25, T30, T40, T45, T50, T55, T60
	75mm	x8	T20, T25, T30, T40, T45, T50, T55, T60
	30mm	x5	M5, M6, M8, M10, M12
	75mm	x5	M5, M6, M8, M10, M12
	30mm	x8	R5, R6, R7, R8, R9, R10, R12, R14
	75mm	x8	R5, R6, R7, R8, R9, R10, R12, R14
	30mm	x8	TT20, TT25, TT30, TT40, TT45, TT50, TT55, TT60
	75mm	x8	TT20, TT25, TT30, TT40, TT45, TT50, TT55, TT60

52753

107,00€

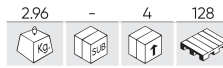

CAIXA DE FERRAMENTAS DE 55 PONTAS - HEAVY DUTY



REPOSIÇÕES DISPONÍVEIS



	3/8"	x1	10mm
	1/2"	x2	10, 14mm
	30mm	x9	4, 5, 6, 7, 8, 10, 12, 14, 16mm - ISO 2136
	75mm	x9	4, 5, 6, 7, 8, 10, 12, 14, 16mm - ISO 2136
	30mm	x10	T20, T25, T30, T40, T45, T50, T55, T60, T70, T80 - DIN 2325
	75mm	x10	T20, T25, T30, T40, T45, T50, T55, T60, T70, T80 - DIN 2325
	30mm	x7	M5, M6, M8, M10, M12, M14, M16 - DIN 2325
	75mm	x7	M5, M6, M8, M10, M12, M14, M16 - DIN 2325

53574

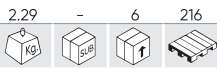

CAIXA DE 208 BITS

	x12	1.5, 2, 2.5, 3, 3.5, 4, 4.5, 5, 5.5, 6, 7, 8mm
	x10	1/16, 5/64, 3/32, 7/64, 1/8, 9/64, 5/32, 3/16, 7/32, 1/4
	x5	2.5, 3, 4, 5, 6mm
	x5	2.5, 3, 4, 5, 6mm
	x18	PH00, PH0, PH1(x5), PH2(x5), PH3(x5), PH4
	x3	PH1, PH2, PH3
	x3	PH1, PH2, PH3
	x17	PZ00, PZ0, PZ1(x5), PZ2(x5), PZ3(x4), PZ4
	x3	PZ1, PZ2, PZ3
	x3	PZ1, PZ2, PZ3
	x14	T5, T6, T7, T8, T9, T10, T15, T20, T25, T27, T30, T35, T40, T45
	x7	T10, T15, T20, T25, T27, T30, T40
	x7	T10, T15, T20, T25, T27, T30, T40
	x10	4, 5, 6, 7, 8, 9, 10, 11, 12, 13
	x10	5/32, 3/16, 7/32, 1/4, 9/32, 5/16, 11/32, 3/8, 7/16, 1/2
	x1	
	x3	6, 8, 10mm
	x3	6, 8, 10mm
	x4	4, 6, 8, 10mm
	x4	4, 6, 8, 10mm

49,50€



	x4	1, 2, 3, 4mm
	x4	1, 2, 3, 4mm
	x6	2, 2.5, 3, 4, 5, 6mm
	x6	5/64, 3/32, 7/64, 1/8, 9/64, 5/32
	x13	T5, 6, 7, 8, 9, 10, 15, 20, 25, 27, 30, 40, 45
	x3	1, 2, 3mm
	x4	0, 1, 2, 3mm
	x3	M5, M6, M8
	x9	TS10, TS15, TS20, TS25, TS27, TS30, TS40, TS45, TS50
	x12	SL2, SL2.5, SL3, SL3.5, SL4, SL4.5, SL5, SL5.5, SL6, SL6.5, SL7, SL8
	x1	1/4"
	x1	



8,80€

52620

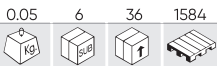

PORTAPUNTAS ANGULAR

52539



CAIXA DE PONTAS VARIADAS

59,00€

52538



CAIXA DE PONTAS VARIADAS

62,00€



REPOSIÇÕES DISPONÍVEIS



	x10	PH3, PH4
	x10	PZ3, PZ4
	x25	7, 8, 10, 12, 14mm
	x15	SL8, SL10, SL12
	x25	T40, T45, T50, T55, T60



REPOSIÇÕES DISPONÍVEIS



	x10	PH1, PH2
	x10	PZ1, PZ2
	x20	3, 4, 5, 6mm
	x15	SL4, SL5.5, SL6.5
	x35	T8, T10, T15, T20, T25, T27, T30

53156

26,20€

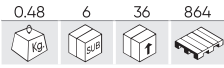

CAIXA DE FERRAMENTAS DE 37 PEÇAS COM MINI ROQUETE DE 1/4"



REPOSIÇÕES DISPONÍVEIS



	1/4"	x11	4, 4.5, 5, 6, 7, 8, 9, 10, 11, 12, 13mm
	1/4"	x1	72
		x2	PH3, PH4
		x2	PZ3, PZ4
	6mm	x5	4, 5, 6, 7, 8mm
		x3	SL6, SL8, SL10
	6mm	x8	T8, T9, T10, T15, T20, T25, T30, T40
		x4	M5, M6, M9, M10
		x1	1/4"

52198

37,70€

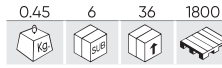

CAIXA DE FERRAMENTAS DE 37 PEÇAS COM MINI ROQUETE DE 1/4"



REPOSIÇÕES DISPONÍVEIS



	1/4"	x11	4, 4.5, 5, 6, 7, 8, 9, 10, 11, 12, 13mm
	1/4"	x1	72
		x2	PH3, PH4
		x2	PZ3, PZ4
	6mm	x5	4, 5, 6, 7, 8mm
		x3	SL6, SL8, SL10
	6mm	x8	T8, T9, T10, T15, T20, T25, T30, T40
		x4	M5, M6, M9, M10
		x1	1/4"

51333

18,00€

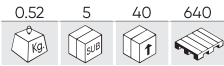

JOGO DE 6 ADAPTADORES



REPOSIÇÕES DISPONÍVEIS



x6	1/4H-3/8M, 1/4M-3/8H, 1/2H-3/4M, 3/8H-1/2M, 1/2H-3/8M, 3/4H-1/2M
----	--

53743

39,70€

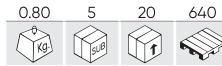

CONJUNTO DE 6 ADAPTADORES DE IMPACTO



REPOSIÇÕES DISPONÍVEIS



x6	1/4H-3/8M, 3/8H-1/4M, 3/8H-1/2M, 1/2H-3/8M, 1/2H-3/4M, 3/4H-1/2M
----	--

54586

5,00€

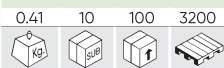

CONJUNTO DE 3 ADAPTADORES DE CHAVES DE CAIXA COM PONTA HEXAGONAL

x1	1/2"	73mm
x1	3/8"	65mm
x1	1/4"	65mm



KIT DE PONTAS

REF.											€
52714	0.65	4	24	576	CrV	10 PCS		1/2"	10, 11, 12, 13, 14, 15, 16, 17, 18, 19mm	17,00€	
52715	0.35	6	36	1152	CrV	13 PCS		1/4"	4, 4.5, 5, 5.5, 6, 7, 8, 9, 10, 11, 12, 13, 14mm	11,00€	
52716	0.61	4	24	576	CrV	10 PCS		1/2"	10, 11, 12, 13, 14, 15, 16, 17, 18, 19mm	17,00€	
52717	0.27	6	36	1152	CrV	13 PCS		1/4"	4, 4.5, 5, 5.5, 6, 7, 8, 9, 10, 11, 12, 13, 14mm	11,00€	

52714



52715



52716



52717



KIT DE CHAVES DE CAIXA

REF.											€
51409	0.35	5	50	-	CrV	6 PCS		1/2"	M10, M12, M14, M16, M18, M20	36,00€	
51410	0.38	5	50	500	CrV	6 PCS		1/2"	T55, T60, T70, T80, T90, T100	36,00€	

51409



51410



CHAVE PONTA 1/2" XZN INVIOLÁVEL

REF.											€
12029	0.17	5	100	1500	CrV	1 PCS		1/2"	M16x58mm	5,50€	
12030	0.25	8	80	-	CrV	1 PCS		1/2"	M16x100mm	7,10€	

12029



12030



VARILHA EXTRA-LARGA DE 12 FACES DE 800mm de 1/2"

REF.										€
52059	0.57	-	25	1750	CrV	1 PCS		1/2"	Ø 8mm - 800mm	29,00€
52060	0.57	-	25	1750	CrV	1 PCS			Ø 10mm - 800mm	32,00€
53667	0.80	10	20	-	CrV	1 PCS			Ø 12mm - 800mm	32,00€
53668	1.05	10	20	-	CrV	1 PCS			Ø 14mm - 800mm	34,00€



KIT DE CHAVES DE CAIXA

52908

19,90€

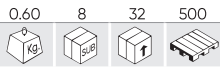

	1/4"	x3	PH0, PH1, PH2		1/4"	x4	3, 4, 5, 6mm
	1/4"	x3	PZ0, PZ1, PZ2		1/4"	x8	T8, T9, T10, T15, T20, T25, T27, T30
	1/4"	x4	SL4, SL5.5, SL6.5, SL7		1/4"	x8	T8, T9, T10, T15, T20, T25, T27, T30



52909

14,00€

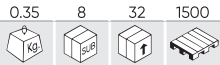

	1/4"	x2	PH1, PH2		1/4"	x4	3, 4, 5, 6mm
	1/4"	x2	PZ1, PZ2		1/4"	x7	T8, T10, T15, T20, T25, T27, T30
	1/4"	x3	SL4, SL5.5, SL6.5				



51746

12,00€

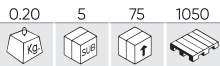

	1/4"	x7	TS10, TS15, TS20, TS25, TS30, TS40, TS45
--	------	----	--

53127

12,00€

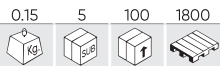

	1/4"	x7	TS10, TS15, TS20, TS25, TS30, TS40, TS45
--	------	----	--



54545

18,60€

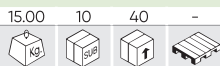

	3/8"	x9	4, 5, 6, 7, 8, 9, 10, 12, 14mm
--	------	----	--------------------------------



54546

20,00€

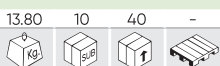

	3/8"	x10	T10, T15, T20, T25, T27, T30, T40, T45, T50, T55
--	------	-----	--

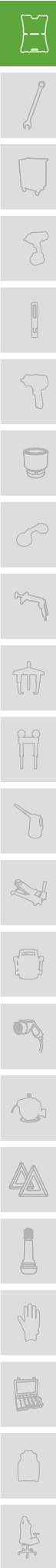

53084

24,00€

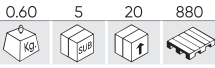

	1/2"	x3	100mm - T55, T60, T70
	3/8"	x4	90mm - T30, T40, T45, T50

50980

23,50€

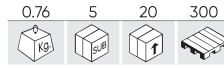

	1/2"	x3	100mm - M12, M13, M14
	3/8"	x4	90mm - M6, M7, M8, M10

50982

22,00€

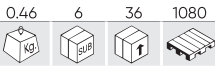

	3/8"	x7	100mm - 3, 4, 5, 6, 7, 8, 10mm
--	------	----	--------------------------------

52320

23,00€

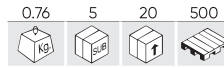

	1/2"	x3	100mm - M12, M13, M14
	3/8"	x4	90mm - M6, M7, M8, M10

54091

441,00€

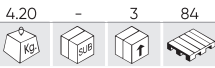

MALETA DE FERREMENTA ISOLADA - 26PEÇAS



REPOSIÇÕES DISPONÍVEIS



	3/8"	x10	8, 10, 11, 12, 13, 14, 16, 17, 19, 22mm
	3/8"	x1	200mm
	1/2"	x1	125mm
	3/8"	x1	200mm
		x2	4x100, 5x125mmL
		x2	PH1x80, PH2x100mm
		x1	185mm
		x1	
		x6	7x86, 8x99, 10x109, 12x127, 14x141, 17x156mm
		x1	185mm

54093

441,00€



MÓDULO EVA DE FERRAMENTA ISOLADA



REPOSIÇÕES DISPONÍVEIS



	3/8"	x10	8, 10, 11, 12, 13, 14, 16, 17, 19, 22mm
	3/8"	x1	200mm
	1/2"	x1	125mm
	3/8"	x1	200mm
		x2	4x100, 5x125mmL
		x2	PH1x80, PH2x100mm
		x1	185mm
		x1	
		x6	7x86, 8x99, 10x109, 12x127, 14x141, 17x156mm
		x1	185mm

15162

32,50€

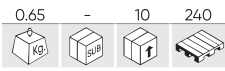

MÓDULO DE 8 CHAVES DE FENDAS ISOLADAS VDE

	x4	0.5x3.0x75, 0.8x4.0x100, 1.0x5.5x125, 1.2x6.5x150mm
	x3	PH0x75, PH1x80, PH2x100mm
	x1	SL3x140mm



REPOSIÇÕES DISPONÍVEIS

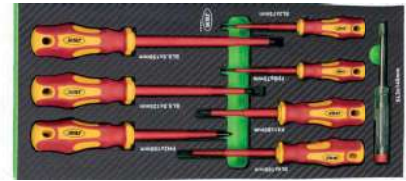

53154

462,00€

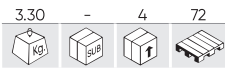

MALETA DE FERRAMENTA ISOLADA 20 PEÇAS DE 3/8"

	3/8"	x12	8, 10, 11, 12, 13, 14, 16, 17, 18, 19, 21, 22mm
	3/8"	x1	200mm
	3/8"	x2	125, 250mm
	3/8"	x1	200mm
	3/8"	x4	4, 5, 6, 8mm (75mm)



52519

25,50€

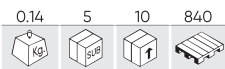

KIT DE 7 CHAVES ISOLADAS ATÉ 1.000V

	x2	PH00x50, PH0x50mm
	x5	SL1.5x0.23x50, SL1.8x0.30x50, SL2.0x0.40x50, SL2.5x0.40x50, SL3.0x0.50x50mm

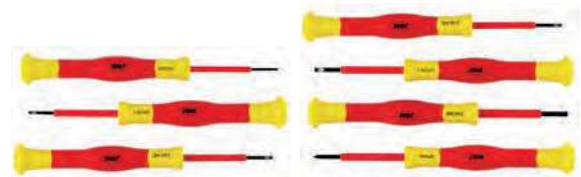

54562

68,50€



CONJUNTO DE CHAVES DE FENDAS INTERCAMBIÁVEIS 25PCS ISOLADAS

	x3	PH0x75, PH1x100, PH2x100mm
	x3	PZ0x75, PZ1x100, PZ2x100mm
	x6	SL2.5x75, SL3.0x75, SL3.5x75, SL4.0x100, SL5.5x100, SL6.5x100
	x11	T5x75, T6x75, T7x75, T8x75, T9x75, T10x75, T15x75, T20x75, T25x75, T27x75, T30x75mm
	x1	140mm



53165

19,60€

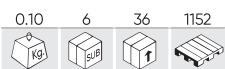

NAVALHA CORTA CABOS ISOLADA (CURVADA)



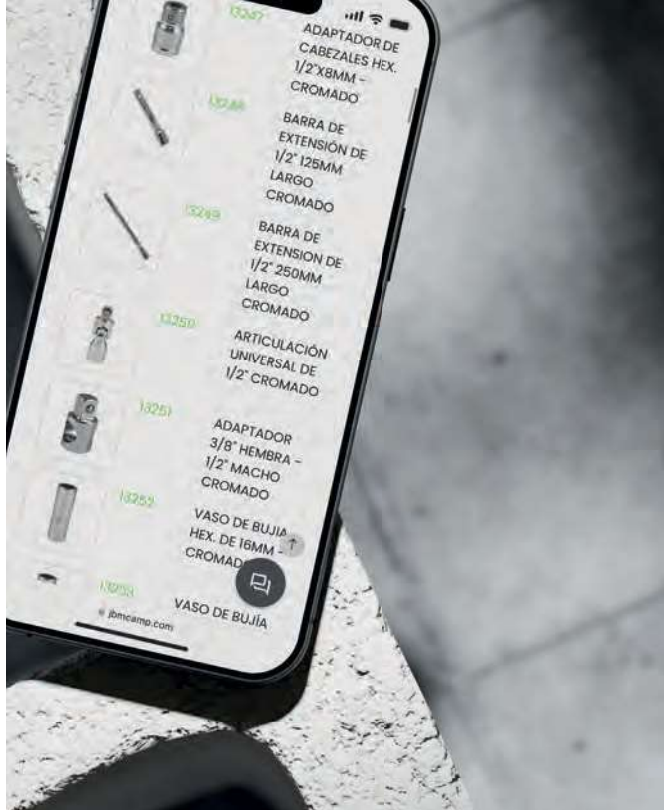
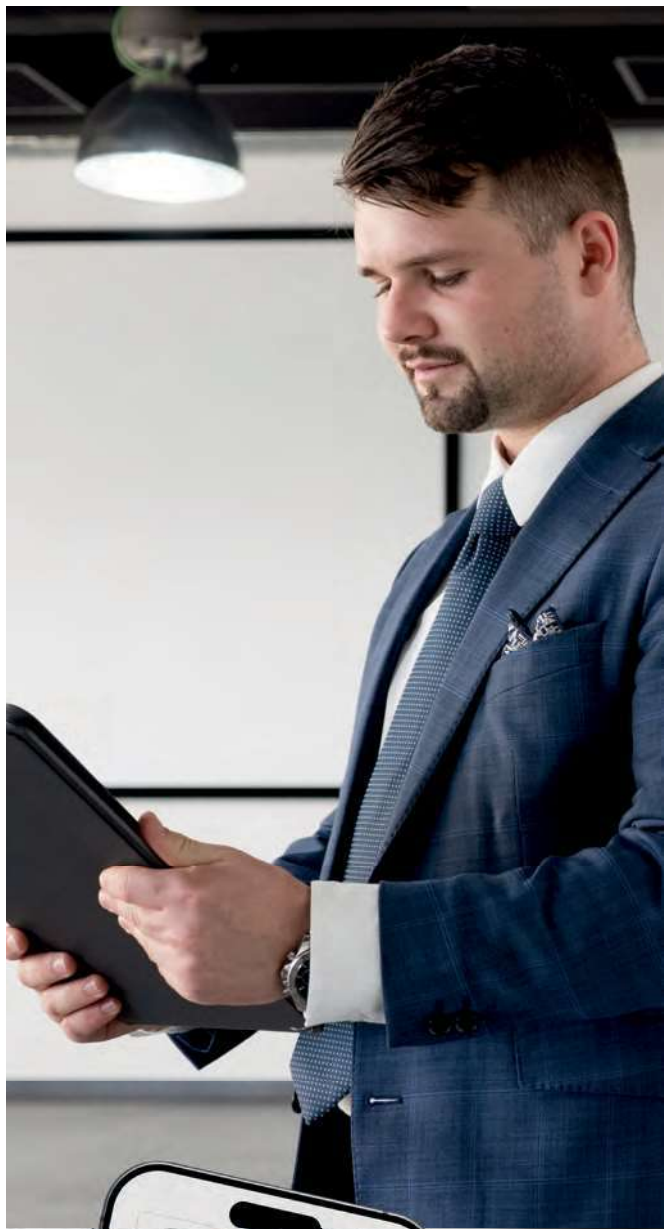
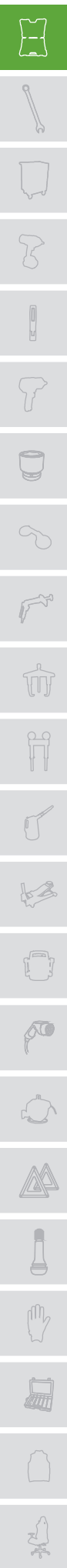

PRECISA DE UMA PEÇA SOBRESSELENTE?

ENCONTRE-A NO WEBSITE DA JBM

01 ABRA O LEITOR DE CÓDIGOS QR

Pode abrir a câmara do seu telemóvel para ler códigos QR.

02 APONTE A CÂMARA PARA UM CÓDIGO QR

Encontrará códigos QR em todos os produtos com vistas ampliadas.

03 SELECIONE O IDIOMA

Escolha a língua em que pretende abrir a página Web.

04 ANALISE A VISTA AMPLIADA

Poderá ver todas as referências que o produto contém.

05 NAVEGUE NO WEBSITE

Marque o produto, adicione-o ao seu carrinho ou compre-o diretamente a nós



FERRAMENTAS MANUAIS

CHAVES	38	FERRAMENTAS DE INSPEÇÃO	65
SARGENTOS	47	MARTELOS	66
CATRACAS	48	FERRAMENTAS DE CORTE	67
CHAVES DINAMOMETRICAS	51	CINZÉIS	68
BARRAS DE EXTENSÃO	53	REBITADORES	69
CHAVES DE FENDAS	54	FERRAMENTAS DE MEDIÇÃO	72
ALICATES	57	DIVERSOS	73



54101

65,00€

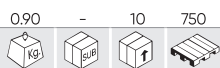

CONJUNTO DE 6 CHAVES COMBINADAS COM ROQUETE



REPOSIÇÕES DISPONÍVEIS

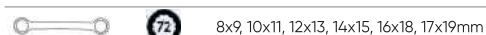

53017

57,00€

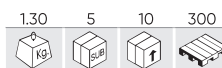

CONJUNTO DE 7 CHAVES ARTICULADAS DE BOCA-LUNETAS COM ROQUETE



REPOSIÇÕES DISPONÍVEIS



54117

74,00€

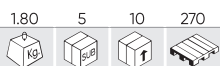

CONJUNTO DE CHAVES COMBINADAS COM ROQUETE



REPOSIÇÕES DISPONÍVEIS



51318

98,00€

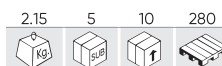

CONJUNTO DE 12 CHAVES ARTICULADAS DE BOCA-LUNETAS COM ROQUETE



REPOSIÇÕES DISPONÍVEIS

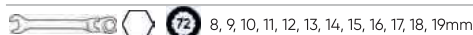

54041

198,00€

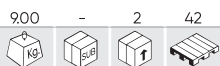

CONJUNTO DE 22 CHAVES DE CATRACA COMBINADAS EM ESTOJO



REPOSIÇÕES DISPONÍVEIS

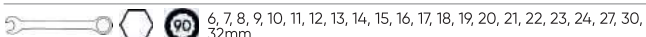



53018

127,00€



CONJUNTO DE 6 CHAVES DE CATRACA ARTICULADAS EM MALA



REPOSIÇÕES DISPONÍVEIS



8x9, 10x11, 12x13, 14x15, 16x18, 17x19mm

54338

65,00€

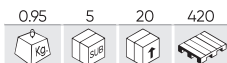

CHAVE DE ROQUETE COM CABEÇA INTERMUTÁVEL 12 PEÇAS



REPOSIÇÕES DISPONÍVEIS



8, 9, 10, 11, 12, 13, 14, 15, 16, 17, 18, 19mm

54110

48,50€

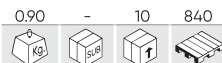

CONJUNTO DE 8 MINI CHAVES COMBINADAS COM ROQUETE



REPOSIÇÕES DISPONÍVEIS



10, 11, 12, 13, 14, 15, 17, 19mm

15316

58,00€

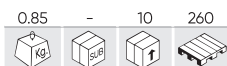

CONJUNTO DE 3 CHAVES COM 72 DENTES - TIPO 4 EM 1



REPOSIÇÕES DISPONÍVEIS



12-13x8-10mm, 14-15x9-11mm, 18-19x16-17mm

54066

83,00€



MÓDULO DE 7 CHAVES DE CATRACA EXTRA LONGAS



REPOSIÇÕES DISPONÍVEIS



8, 10, 12, 13, 14, 17, 19mm

54032

84,00€

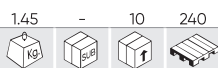

MÓDULO DE 12 MINI CHAVES COMBINADAS ARTICULADAS COM ROQUETE



REPOSIÇÕES DISPONÍVEIS

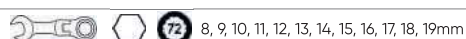

15122

80,00€

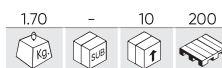

MÓDULO DE CARBONO EVA DE 12 CHAVES COMBINADAS COM ROQUETE



REPOSIÇÕES DISPONÍVEIS

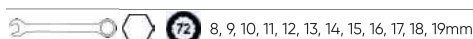

54079

83,00€



CONJUNTO DE 21 CHAVES COMBINADAS



REPOSIÇÕES DISPONÍVEIS

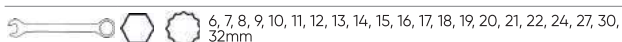

54097

39,00€



CONJUNTO DE 14 CHAVES COMBINADAS



REPOSIÇÕES DISPONÍVEIS

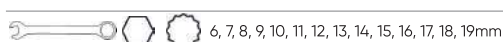

54120

63,00€



CONJUNTO DE 7 CHAVES COMBINADAS



REPOSIÇÕES DISPONÍVEIS



54174

139,00€



CONJUNTO DE 6 CHAVES COMBINADAS



REPOSIÇÕES DISPONÍVEIS



50564

30,00€

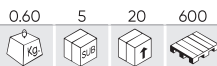

CONJUNTO DE 8 CHAVES COMBINADAS CURTAS



REPOSIÇÕES DISPONÍVEIS



54150

24,00€



CONJUNTO DE 7 CHAVES FIXAS



REPOSIÇÕES DISPONÍVEIS

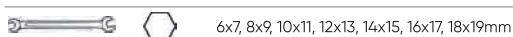

54149

60,00€

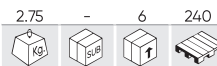

CONJUNTO DE 12 CHAVES FIXAS



REPOSIÇÕES DISPONÍVEIS

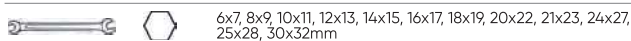

54115

29,00€

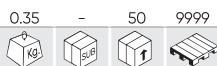

CONJUNTO DE 4 CHAVES TORX FIXAS



REPOSIÇÕES DISPONÍVEIS



54081

28,00€

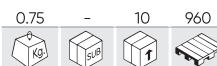

CONJUNTO DE 5 CHAVES HEXAGONAIS ABERTAS COM 6 ARESTAS



REPOSIÇÕES DISPONÍVEIS

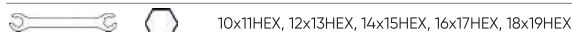

54159

49,50€

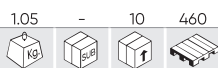

CONJUNTO DE 8 CHAVES TIPO "C" CABEÇAL REDONDO 12 CANTOS



REPOSIÇÕES DISPONÍVEIS

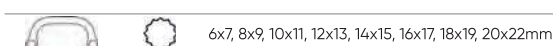

50562

25,50€

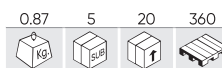

CONJUNTO DE 7 CHAVES FIXAS COM DUAS ABERTURAS



REPOSIÇÕES DISPONÍVEIS

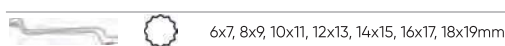

15156

70,00€

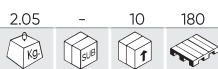

MÓDULO EVA COM 4 CHAVES ANGULARES



REPOSIÇÕES DISPONÍVEIS

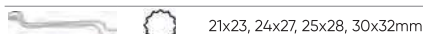

54119

78,00€

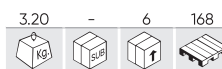

CONJUNTO DE 12 CHAVES FIXAS CURVADAS



REPOSIÇÕES DISPONÍVEIS

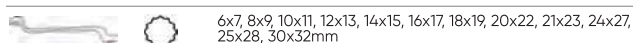

53654

81,00€

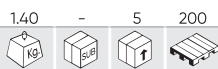

CONJUNTO DE CHAVES DE GANCHO NA MALA

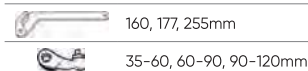

51528

54,00€

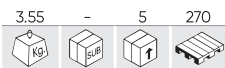

CONJUNTO 14 CHAVES DE TUBOS DUPLAS DE EXTREMIDADE ABERTA



REPOSIÇÕES DISPONÍVEIS



8, 9, 10, 11, 12, 13, 14, 15, 16, 17, 18, 19, 20, 21mm

53420

76,00€

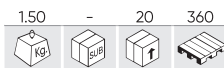

CONJUNTO DE 8 CHAVES DE TUBO



REPOSIÇÕES DISPONÍVEIS



6x7, 8x9, 10x11, 12x13, 14x15, 16x17, 18x19, 20x22mm

53979

38,00€

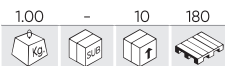

CONJUNTO DE 8 CHAVES TORX EM FORMA DE "T" EM MÓDULO



REPOSIÇÕES DISPONÍVEIS



T10x75, T15x75, T20x100, T25x100, T30x150, T40x150, T45x200, T50x200mm

53980

38,00€

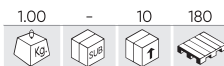

MÓDULO DE 8 CHAVES ALLEN EM FORMA DE "T"



REPOSIÇÕES DISPONÍVEIS



H2x100, H2.5x100, H3x100, H4x150, H5x150, H6x200, H8x200, H10x200

54481

113,00€



MÓDULO DE 7 CHAVES DE CAIXA COM CABO EM T (7-19 MM)



REPOSIÇÕES DISPONÍVEIS



7, 8, 9, 10, 13, 17, 19mm (555mm)

54380

119,00€



CONJUNTO DE 9 SOQUETES COM CABO EM T (7-19MM)



REPOSIÇÕES DISPONÍVEIS



7, 8, 10, 11, 13, 14, 15, 17, 19mm (465mm)

51864

64,00€

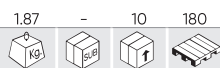

MÓDULO DE 6 CHAVES DE PORCAS EXTRA-LONGAS COM 12 ARESTAS



REPOSIÇÕES DISPONÍVEIS



10x11, 12x14, 13x15, 16x18, 17x19, 22x24mm

52912

94,00€

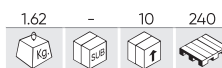

MÓDULO DE 6 CHAVES TORX EXTRA LONGAS



REPOSIÇÕES DISPONÍVEIS



E6xE7, E8xE10, E11xE12, E14xE16, E18xE20, E22xE24

CONJUNTO DE 9 BOCAIS

TORX

REF.	PCS	mm	CONTÉM					€
53737	9	90-218mm	T10, T15, T20, T25, T27, T30, T40, T45, T50	0.42	10	40	1000	12,80€
53739	9	86-150mm	T10, T15, T20, T25, T27, T30, T40, T45, T50	0.32	10	40	960	10,50€
53955	9	72-170mm	T10, T15, T20, T25, T27, T30, T40, T45, T50	0.25	10	40	1480	10,00€

HEXAGONAIS

REF.	PCS	mm	CONTÉM					€
53738	9	90-220mm	1.5, 2, 2.5, 3, 4, 5, 6, 8, 10mm	0.45	10	40	1000	10,90€
53740	9	72-170mm	1.5, 2, 2.5, 3, 4, 5, 6, 8, 10mm	0.37	10	40	960	9,90€
53954	9	43-97mm	1.5, 2, 2.5, 3, 4, 5, 6, 8, 10mm	0.25	10	40	1480	9,40€

NOVO DESIGN

REF.	PCS	mm	CONTÉM					€
54531	9	90-220mm	1.5, 2, 2.5, 3, 4, 5, 6, 8, 10mm	0.48	10	40	840	14,90€
54532	9	90 - 218mm	T10, T15, T20, T25, T27, T30, T40, T45, T50	0.49	10	40	840	14,90€



53737 - 53739 - 53955



53738 - 53740 - 53954



54531



54532

51659

59,00€

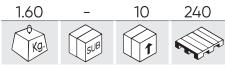

CONJUNTO DE FERRAMENTAS DE 6 CHAVES
12 FACES ARTICULADAS



REPOSIÇÕES
DISPONÍVEIS



8x9, 10x11, 12x13, 14x15, 16x17, 18x19mm

50622

70,00€

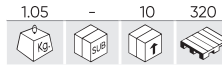

CONJUNTO DE FERRAMENTAS 4 CHAVES
ARTICULADAS TORX



REPOSIÇÕES
DISPONÍVEIS



E6xE8, E10xE12, E14xE18, E20xE24

54187

42,50€

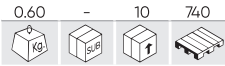

CONJUNTO DE 10 CHAVES PÉ DE GALO 3/8"



REPOSIÇÕES
DISPONÍVEIS



10, 11, 13, 14, 15, 16, 17, 18, 19, 22mm

51416

12,00€

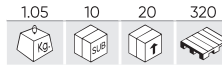

CHAVE DE RODAS EXTENSÍVEL COM CHAVES
REVERSÍVEIS 330-490MM



330-490mm
 17-19, 21-23mm

CHAVE DE RODA JUNTA SOLDADA

REF.	"			mm					€
51661	1/2"		355mm	17, 19, 21mm	1.17	5	20	440	12,00€
52881	1/2"		400mm	17, 19, 21, 22mm	1.40	-	10	480	17,00€
52880	3/4"		700mm	24, 27, 32mm	3.75	-	5	120	42,00€



CHAVE INGLESA

MODELO 1

REF.	"	mm						€
51798	18"	450mm	53mm	1.90	3	12	360	39,60€
52424	24"	610mm	62mm	3.75	-	5	350	64,00€

MODELO 2

REF.	"	mm						€
51795	8"	200mm	22mm	0.28	6	60	3600	9,00€
51796	10"	250mm	28mm	0.48	6	36	2400	14,00€
51797	12"	300mm	37mm	0.71	6	24	960	18,00€

MODELO 3

REF.	"	mm						€
53639	6"	150mm	28mm	0.15	6	96	576	28,60€
53640	8"	200mm	30mm	0.28	6	72	504	34,40€
53641	10"	250mm	33mm	0.50	6	36	1151	41,00€
53642	12"	300mm	40mm	0.83	6	24	-	54,00€
53643	16"	400mm	52mm	1.53	-	12	336	92,00€
54098	20"	640mm	65mm	2.70	-	6	-	158,50€



CHAVE DE GRIFO

REF.	"	mm						€
52235	12"	300mm	50mm	0.90	6	24	1140	11,50€
52236	14"	350mm	60mm	1.09	6	24	760	14,30€
52237	18"	450mm	70mm	1.75	4	12	720	18,10€
52238	24"	600mm	75mm	2.50	2	8	600	26,50€
53210	36"	915mm	110mm	4.95	-	4	96	48,00€

REF.	"	mm						€
53070	12"	270mm	45mm	0.68	6	24	900	17,30€
53071	14"	320mm	50mm	0.92	4	12	900	27,50€
53072	18"	410mm	65mm	1.35	4	12	900	34,00€
53073	24"	540mm	75mm	2.05	2	8	1000	50,00€



FERRAMENTAS EM POLEGADA

51890

92,00€

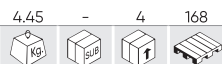

CONJUNTO DE 17 CHAVES COMBINADAS - EM POLEGADA



5/16, 3/8, 7/16, 1/2, 9/16, 19/32, 5/8, 11/16, 3/4, 13/16, 7/8, 15/16, 1", 1" 1/16, 1" 1/8, 1" 3/16, 1" 1/4

54005

14,00€

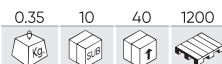

CONJUNTO DE 9 CHAVES ALLEN EM POLEGADA



1/16", 5/64", 3/32", 1/8", 5/32", 3/16", 1/4", 5/16", 3/8"
690, 750, 820, 910, 103, 118, 133, 155, 177mm

54106

89,00€



CAIXA DE FERRAMENTAS EM POLEGADAS ZINCADA COM 36 PEÇAS



	1/2" x17	5/16", 3/8", 7/16", 1/2", 9/16", 19/32", 5/8", 11/16", 3/4", 13/16", 7/8", 15/16", 1", 1-1/16", 1-1/8", 1-3/16", 1-1/4"			
	1/4" x8	3/16", 7/32", 1/4", 9/32", 5/16", 11/32", 3/8", 7/16"			
	1/2" x2	16, 21mm		1/4" x1	
	1/2" x2	5", 10"		1/2", 1/4" x2	72
	1/4" x1	3"		1/2", 1/4" x2	
	x1			1/2", 1/4" x1	

SARGENTO

REF.	mm					€
52349	90x200mm	1.25	-	10	480	24,00€
52350	90x300mm	1.41	-	10	540	24,50€
52351	90x400mm	1.60	-	10	480	27,50€
52352	120x300mm	1.99	-	10	360	35,00€
52353	120x400mm	2.10	-	10	350	36,00€
52354	120x500mm	2.41	-	6	300	36,50€
52355	120x600mm	2.62	-	4	300	39,00€
52357	150x800mm	4.60	-	5	125	54,00€
52358	150x1000mm	5.35	-	5	120	67,00€



ROQUETE DE 72 DENTES

PADRÃO

REF.	"	mm	ACABADO					€
54022	1/4"	145mm	Cromado	0.15	12	36	2016	10,00€
54023	3/8"	200mm	Cromado	0.30	12	24	1440	14,00€
54024	1/2"	255mm	Cromado	0.60	12	24	960	18,00€
54018	1/4"	145mm	Zincado	0.15	12	36	2016	10,00€
54021	3/8"	200mm	Zincado	0.60	12	24	1440	14,00€
54019	1/2"	255mm	Zincado	0.60	12	24	960	18,00€

EM EXPOSITOR DE 12 UDS

RETO

REF.	"	mm	ACABADO					€
54083	1/4"	145mm	Zincado	0.14	12	24	2592	10,50€
54084	3/8"	200mm	Zincado	0.30	12	24	1440	14,10€
54085	1/2"	255mm	Zincado	0.60	12	24	960	19,20€

EM EXPOSITOR DE 12 UDS

CABEÇA GIRATÓRIA

REF.	"	mm	ACABADO					€
51405	1/4"	145mm	Zincado	0.58	12	24	-	21,10€
51406	1/2"	280mm	Cromado	0.66	12	24	864	29,20€

EM EXPOSITOR DE 12 UDS

EXTENSÍVEL

REF.	"	mm	ACABADO					€
53346	1/4"	150-200mm	Zincado	0.25	6	12	-	18,30€
51307	1/2"	305-445mm	Zincado	0.92	6	12	360	29,70€
54304	1/2"	450-610mm	Zincado	1.15	-	6	480	29,00€

EM EXPOSITOR DE 6 UDS

RETO COMPACTO

REF.	"	mm	ACABADO					€
54086	1/4"	105mm	Zincado	0.10	12	24	2592	10,00€
54087	1/2"	173mm	Zincado	0.50	12	24	1008	18,60€

EM EXPOSITOR DE 12 UDS

MINI

REF.	"	mm	ACABADO					€
52207	1/4"	85mm	Zincado	0.05	12	240	8400	24,20€

EM EXPOSITOR DE 12 UDS



54022
54023
54024

54018
54019
54021



ROQUETE DE 72 DENTES

ARTICULADO ALONGADA

REF.	"	mm	ACABADO					€
53886	1/4"	305mm	Zincado	0.27	10	40	1680	22,00€
53887	3/8"	457mm	Zincado	0.68	10	20	700	33,50€
53888	1/2"	609mm	Zincado	1.27	4	16	480	40,50€

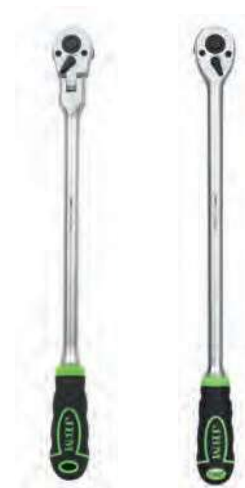

53886
53887
53888

53883
53884
53885

ALONGADA

REF.	"	mm	ACABADO					€
53883	1/4"	305mm	Zincado	0.27	10	40	1680	19,80€
53884	3/8"	457mm	Zincado	0.61	10	20	700	32,50€
53885	1/2"	609mm	Zincado	1.25	4	16	480	35,70€

ARTICULADO

REF.	"	mm	ACABADO					€
52587	1/4"	172mm	Cromado	0.16	12	48	3456	40,00€
52588	1/2"	172mm	Cromado	0.17	12	144	3456	47,50€

EM EXPOSITOR DE 12 UDS



ARTICULADO PEQUENO

REF.	"	mm	ACABADO					€
51306	1/4"	165mm	Cromado	0.30	12	48	816	28,10€
51305	1/2"	175mm	Cromado	0.31	12	48	816	28,90€

EM EXPOSITOR DE 12 UDS



ARTICULADA EXTENSÍVEL

REF.	"	mm	ACABADO					€
52197	1/2"	350-490mm	Zincado	1.04	6	12	468	36,30€

EM EXPOSITOR DE 6 UDS



FLEXÍVEL

REF.	"	mm	ACABADO					€
51801	3/8"	500mm	Cromado	0.56	10	40	160	62,00€



CONJUNTO DE 3 ROQUETES CURTOS

REF.	"	mm	ACABADO					€
53671	1/4"	85mm	Cromado	0.85	-	10	520	41,00€
	3/8"	102mm	Cromado					
	1/2"	135mm	Cromado					

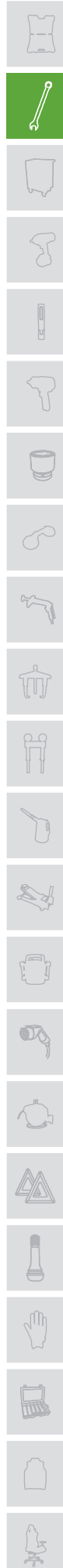

COM CHAVES

REF.	"	ACABADO	PERFIL	COM CHAVES					€
54028	1/2"	Zincado		10, 11, 12, 13, 14, 15, 16, 17, 18, 19mm	1.30	4	24	432	29,00€
54029	1/2"	Zincado			1.25	4	24	432	29,00€
54030	1/4"	Zincado		4, 5, 6, 7, 8, 9, 10, 11, 12, 13mm	0.35	6	36	1008	19,00€
54031	1/4"	Zincado			0.35	6	36	864	19,00€



54028



REPOSIÇÕES DISPONÍVEIS



54029



REPOSIÇÕES DISPONÍVEIS



54030



REPOSIÇÕES DISPONÍVEIS



54031



REPOSIÇÕES DISPONÍVEIS

ROQUETE DE 120 DENTES

REF.	"	Nm	ACABADO					€
54647	1/4"	100Nm	Zincado	0.35	12	24	-	18,00€
54648	3/8"	360Nm	Zincado	1.90	12	24	-	19,00€
54649	1/2"	900Nm	Zincado	1.90	12	24	-	24,00€



VOCÊ PODE GOSTAR...

PEÇA DE REPOSIÇÃO

REF.	"	REF.					€
15147	3/8"	REF.53884, 53887	0.10	-	100	-	6,60€
15148	1/2"	REF.53885, 53888	0.20	-	100	-	6,60€
15149	1/4"	REF.53883, 53886	0.05	-	100	-	6,60€



KIT DE REPARO PARA CHAVE CATRACA

REF.	"	REF.					€
15138	1/4"	REF.53671, 54030, 54031, 54022, 54018, 54083, 54086	0.10	-	50	-	11,70€
15139	3/8"	REF.53671, 54023, 54021, 54084	0.15	-	50	-	13,70€
15140	1/2"	REF.53671, 54028, 54029, 54024, 54019, 54085, 54087	0.20	-	50	-	15,60€



CHAVE ARTICULADA

REF.	"	mm						€
52524	3/4"	1020mm	3.60	3	6	144		56,00€
52526	1/2"	600mm	1.65	5	10	810		28,40€
52525	1/2"	430mm	0.85	10	20	1500		14,00€
54343	1/2"	450-600mm	1.15	-	6	594		33,00€

52524



REPOSIÇÕES DISPONÍVEIS

52526



REPOSIÇÕES DISPONÍVEIS

52525



REPOSIÇÕES DISPONÍVEIS

52524



52526



52525



54343



ADAPTADOR DE ENCAIXE

REF.	"	mm						€
53468	1/2"	250mm	0.35	6	48	600		9,20€
53478	1/4"	115mm	0.50	5	100	1200		4,80€
53479	3/8"	200mm	0.15	5	50	300		6,40€
53480	3/4"	460mm	1.35	5	10	480		20,50€
53481	1"	550mm	2.85	-	5	300		27,50€

53468



53478



53479



53480



53481



54339

273,00€



CHAVE DINAMOMÉTRICA DIGITAL 1/2" 10-200NM

Peças	1
Medida do quadrado	1/2"
Medição	0-360° (Torque-Grados/Degrees)
Faixa de torque	10-200Nm
Precisão (sentido horário)	±2%
Precisão (sentido anti-horário)	±3%
Unidades de medida	Nm, In/Lb, Ft/Lb, Kg/cm, Grados/Degrees
Comprimento	530mm
Peso	1,34Kg



VÍDEO TUTORIAL



53972

550,00€

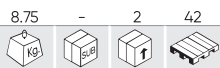

CHAVE DINAMOMÉTRICA 3/4"



Peças	1
Medida do quadrado	3/4"
Material	Acero/Steel - SMC440
Número de dentes	72
Faixa de torque	200-800Nm
Precisão (sentido horário)	±3%
Unidades de medida	Nm
Comprimento	1000-1210mm
Peso	8,75Kg

52913

292,00€

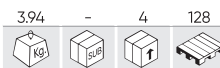

CHAVE DINAMOMÉTRICA COM CABEÇA INTERCAMBIÁVEL, 200NM



REPOSIÇÕES DISPONÍVEIS

Peças	11
Medida do quadrado	1/2"
Material	CrV
Número de dentes	72
Faixa de torque	40-200Nm
Precisão (sentido horário)	±3%
Unidades de medida	Nm
Comprimento	325mm
Peso	3,94Kg

54269

56,00€

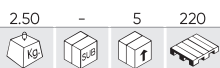

CONJUNTO DE 21 PEÇAS COM CHAVE DINAMOMÉTRICA DE 1/4 DE POLEGADA

	x1	5-25Nm		x3	PH1, PH2, PH3
	x1	100mm		x8	H2, H2.5, H3, H4, H5, H6, H8, H10 (37mmL)
	x1	UNIVERSAL		x1	H5 (87mmL)
	x1	1/4" (F) - 3/8" (M)		x5	T10, T15, T20, T25, T30



REPOSIÇÕES DISPONÍVEIS



51830

99,00€

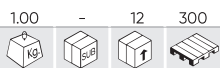

CHAVE DINAMOMÉTRICA MECÂNICA



Peças	33
Medida do quadrado	1/4"
Faixa de torque	2-10Nm
Comprimento	242mm
Peso	1,00Kg



CHAVE DINAMOMÉTRICA

REF.	"	mm	Nm					€
54526	1/4"	235mm	5-25Nm	0.71	5	10	420	41,00€
54533	3/8"	420mm	20-120Nm	1.54	5	10	320	56,00€
54527	1/2"	430mm	40-210Nm	1.69	5	10	320	64,00€
51262	1/4"	270mm	5-25Nm	0.80	4	16	384	51,00€
51338	3/8"	365mm	19-110Nm	1.05	4	16	352	53,00€
51127	1/2"	470mm	28-210Nm	1.70	4	8	256	56,00€



54526 - 54533 - 54527

51127 - 51262 - 51338

CHAVE DINAMOMÉTRICA COM O APROFUNDAMENTO

REF.	"	mm	Nm					€
54529	1/4"	280mm	3-25Nm	0.78	-	10	520	84,00€
54530	1/2"	515mm	20-200Nm	1.90	-	10	210	105,00€
53081	1/4"	375mm	4-20Nm	1.10	5	25	350	115,00€
53082	1/2"	560mm	40-210Nm	1.90	4	8	168	148,00€



54529 - 54530

53081 - 53082

KIT EXTENSOR

REF.	"	PÉ	PCS	mm					€
51805	1/4"	Pé redondo	5 PCS	50, 75, 100, 152, 227mm	0.33	4	20	640	17,00€
51447	1/4"	Pé normal	5 PCS	50, 75, 100, 152, 227mm	0.34	5	20	960	16,00€
51448	1/2"	Pé redondo	5 PCS	50, 125, 250, 380, 510mm	2.38	-	5	270	52,00€

51805



REPOSIÇÕES DISPONÍVEIS



51447



REPOSIÇÕES DISPONÍVEIS



51448



REPOSIÇÕES DISPONÍVEIS



51479

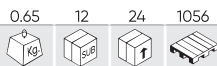

EXTENSOR DE 1/2" COM PÉ REDONDO

1/2" 260-410mm



EM EXPOSITOR DE 12 UDS

54684

23,50€

8.00 - 10 252



CONJUNTO DE 4 CHAVES TORX EXTRALONGAS

450mm T15, T20, T25, T30



REPOSIÇÕES DISPONÍVEIS

54302

13,80€

0.45 10 40 650



CONJUNTO COM 6 CHAVES DE FENDA DE PRECISÃO

- x3 PH00, PH0, PH1
- x3 SL2, SL3, SL4



CHAVE DE FENDA EVA - ACABAMENTO DE CARBONO

REF.	PCS	mm						€
53943	7 PCS	PH4x200, PH3x150, PH2x100, PH2x38, PH1x80, PH1x100, PH0x120	0.80	-	10	240	21,50€	
53944	7 PCS	SL9x200, SL4x125, SL5x100, SL5x80, SL6x38, SL6x100, SL8x150	0.80	-	10	240	19,50€	
53945	7 PCS	T8x75, T9x75, T10x75, T15x75, T20x75, T25x100, T27x100	0.60	-	10	240	18,90€	

53943



REPOSIÇÕES DISPONÍVEIS



53944



REPOSIÇÕES DISPONÍVEIS



53945



REPOSIÇÕES DISPONÍVEIS

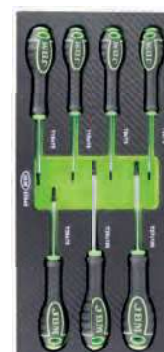

KIT DE CHAVES

REF.	PCS	mm						€
52500	3 PCS	PH00x25, PH0x25, PH1x25	0.33	-	50	1000	19,50€	
	5 PCS	SL0.4x2x25, SL0.4x2.5x25, SL0.5x3.0x25, SL0.5x3.5x25, SL0.8x4x25						
53917	3 PCS	PH00, PH0, PH1	0.20	5	50	950	9,60€	
	4 PCS	SL1.4, SL2.0, SL2.4, SL3.0						



52500



53917

53694

18,40€

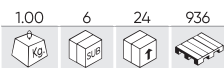

CHAVE DE IMPACTO DE 1/2"

	x3	PH2x36, PH3x36, PH3x70		x1	1/2"
	x3	SL7x36, SL8x36, SL8x70		x1	1/2"



54126

39,00€

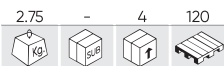

CONJUNTO DE CHAVES DE FENDAS COM PONTA MAGNÉTICA EM MALA DE TRANSPORTE

	x6	PH1x75, PH2x38, PH2x100, PH3x150, PH4x200 (GO-THROUGH), PH0x75mm
	x6	SL5x75, SL6x38, SL6x100, SL8x150, SL9.5x200 (GO-THROUGH), SL3.2x75mm



REPOSIÇÕES DISPONÍVEIS



53010

18,00€

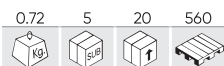

KIT DE DESTORNILLADORES COM CABO INTERCAMBIÁVEL 20 EM 1

	x2	PH1, PH2		x3	T10x15, T20x25, T30x40
	x2	4x6, 5x7mm		x3	H4x4, H5x5, H6x6mm



54551

11,50€

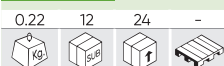

CHAVE DE FENDAS CURTA COM CATRACA 6 EM 1



	x2	4, 5mm
	x2	PH1, PH2
	x2	PZ1, PZ2

EM EXPOSITOR DE 12 UDS

54552

15,00€

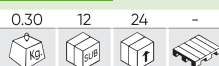

CHAVE DE FENDAS COM CATRACA 12 EM 1



	x3	4, 5, 6mm
	x3	PH1, PH2, PH3
	x3	3, 4, 5mm
	x3	T15, T20, T25

EM EXPOSITOR DE 12 UDS



VÍDEO TUTORIAL

CONJUNTO DE 6 CHAVES DE FENDA

REF.		PCS	mm					€
54070		2 PCS	PH1x80, PH2x100mm	0.50	-	10	440	18,00€
		4 PCS	SL6.5x150, SL5.5x125, SL4x100, SL3x80mm					
54071		3 PCS	PH3x150, PH2x100, PH1x75mm	1.10	-	10	330	26,50€
		3 PCS	SL8x150, SL6.5x100, SL5.5x75mm					

54070



REPOSIÇÕES DISPONÍVEIS



54071



REPOSIÇÕES DISPONÍVEIS



CHAVE COM MULTIFUNÇÃO ESTRELA E FENDA

REF.		PCS	mm					€
54060		2 PCS	SL6x150, PH2x150mm	0.15	10	60	1500	6,00€
54061		2 PCS	SL6x100, PH2x100mm	0.10	10	60	1800	6,00€



CHAVE FLEXÍVEL

REF.		PCS	"							€
52169		4 PCS	1/4"	265mm	6, 7, 8mm	0.45	12	48	672	25,00€
52170		7 PCS	1/4"	265mm	4, 5, 6, 7, 8, 10mm	0.27	12	48	864	16,00€
53575		4 PCS	1/4"	500mm	4, 5, 7mm	0.40	10	40	480	16,00€



50902

13,00€

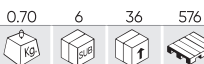

JOGO DE 4 CHAVES DE FENDA DE IMPACTO



	3"	80mm		6"	155mm
	4"	100mm		8"	200mm

53225



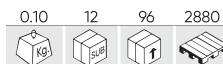

3,70€







MAGNETIZADOR/DESMAGNETIZADOR



ALICATE SEEGER BOCA RETA

REF.		"	mm					€
51018	PARA INTERIORES	7"	180mm	0.14	5	100	2000	7,20€
52964		9"	225mm	0.23	6	60	1440	9,45€
53549		13"	330mm	0.45	5	30	-	14,80€
51017	PARA EXTERIORES	7"	180mm	0.17	5	100	1800	6,90€
52966		9"	225mm	0.28	6	60	1800	9,90€
53547		13"	330mm	0.50	5	30	-	16,20€

ALICATE SEEGER BOCA CURVA

REF.		"	mm					€
51021	PARA INTERIORES	7"	180mm	0.16	5	100	-	7,20€
52965		9"	225mm	0.24	6	60	1440	9,45€
53550		13"	330mm	0.45	5	30	-	14,80€
51020	PARA EXTERIORES	7"	180mm	0.13	5	100	1600	6,90€
52967		9"	225mm	0.24	6	60	1440	9,90€
53548		13"	330mm	0.50	5	30	-	16,20€



51018, 52964, 53549



51021, 52965, 53550





51017, 52966, 53547



51020, 52967, 53548



ALICATE SEEGER

REF.			"	mm					€
54712	BOCA RECTA	PARA INTERIORES	7"	180mm	16.40	5	100	1800	11,00€
54713		PARA EXTERIORES	7"	180mm	16.60	5	100	1800	11,00€
54714	BOCA CURVA	PARA INTERIORES	7"	180mm	16.60	5	100	1800	11,00€
54715		PARA EXTERIORES	7"	180mm	16.40	5	100	1800	11,00€



54712



54713



54714



54715

15454

35,40€

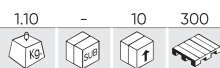

MÓDULO EVA DE ALICATES SEEGER 8" (200MM)



PARA INTERIORES

PARA EXTERIORES



REPOSIÇÕES DISPONÍVEIS

53389

34,00€



CONJUNTO DE ALICATES SEEGER COM PONTAS INTERCAMBIÁVEIS EM MALA DE TRANSPORTE



	x4	0°, 15°, 45°, 90°
	x4	0°, 15°, 45°, 90°
	x2	260mm

51812

48,00€



JOGO DE 5 ALICATES (EM ESTOJO)



REPOSIÇÕES DISPONÍVEIS

	x1	160mm		x1	200mm
	x1	160mm		x1	250mm
	x1	180mm			

ALICATE DE CORTE DIAGONAL

REF.	"	mm					€
53905	6"	160mm	0.20	6	60	1080	7,60€
53906	7"	180mm	0.20	6	60	1440	8,65€







ALICATE DE CORTE DIAGONAL

NOVO DESIGN

REF.	"	mm					€
54711	7"	180mm	16.30	6	60	1620	11,50€







ALICATE DE PONTA ALARGADA

REF.	"	mm					€
53908	6"	160mm	0.15	6	60	1440	7,80€
53909	8"	200mm	0.20	6	60	1440	9,90€







ALICATE DE PONTA ALARGADA

NOVO DESIGN

REF.	"	mm					€
54709	8"	200mm	13.80	6	60	1620	10,50€







ALICATE UNIVERSAL

REF.	"	mm					€
53911	6"	160mm	0.20	6	60	1080	9,00€
54015	7"	180mm	0.20	6	60	1440	10,20€
53967	8"	200mm	0.30	6	60	1440	11,00€









ALICATE UNIVERSAL

NOVO DESIGN

REF.	"	mm					€
54710	7"	180mm	15.50	6	60	1620	11,00€









ALICATE EXTENSÍVEL

REF.							€
50567	250mm	40mm	0.34	10	60	1500	9,60€
52052	515mm	140mm	1.88	2	10	400	57,00€



ALICATE EXTRA-LONGO

REF.								€
52846	340mm	85mm	0°	0.40	-	60	1500	37,80€
52847	335mm	75mm	45°	0.40	-	60	1500	42,50€



25,00€

52272

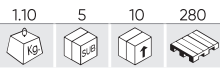

JOGO ALICATES PONTA 0°, 45°, 90°

	0°	280mm
	45°	275mm
	90°	270mm



ALICATE PARA ABRAÇADEIRAS

REF.		mm					€	
52619		20mm	260mm	0.55	6	36	648	23,10€
52812		34mm	270mm	0.85	5	20	500	65,00€



52619



52812

ALICATE PARA ABRAÇADEIRAS

REF.			mm					€	
51995			47mm	630mm	0.53	5	40	480	24,50€
53390			50mm	630mm	1.00	10	20	480	34,50€



ALICATE ABRAÇADEIRAS

REF.		mm					€	
52508		0-38mm	240mm	0.37	10	50	800	41,00€
52509		22-55mm	240mm	0.39	10	50	800	38,50€



52050

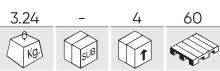

CONJUNTO DE ALICATES DE PRESSÃO NUM ESTOJO DE TRANSPORTE



REPOSIÇÕES DISPONÍVEIS



98,00€

53396 18,30€

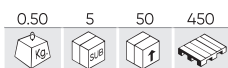

ALICATE PARA ABRAÇADEIRAS DE TUBOS DE ESCAPE



52791 18,00€

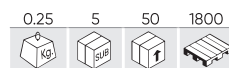

ALICATE PARA ABRAÇADEIRAS CLIC-R



54376 12,80€

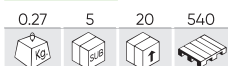

FERRAMENTA PARA ABRAÇADEIRA DA COIFA DA JUNTA HOMOCINÉTICA COM CORTADOR



54311 15,00€

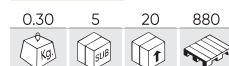

ALICATE PARA ABRAÇADEIRAS



54330 13,70€

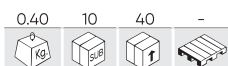

ALICATE DE VEDAÇÃO DA HASTE DA VÁLVULA



54279 6,00€

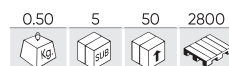

ALICATES PARA EXTRAÇÃO DE LÂMPADAS

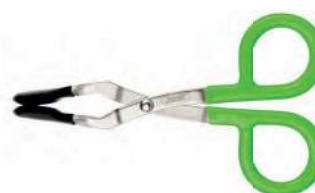

54479 38,50€

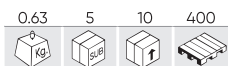

ALICATE PARA CINTAS METÁLICAS COM TRAVAMENTO AUTOMÁTICO



Largura da braçadeira	4.6-12mm
Espessura da braçadeira	0.2-0.4mm

52412

5,90€

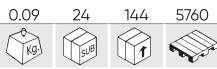

MINI ALICATE MULTIUSOS 105MM

- x2 Chaves de fenda plano
- x1 Ponta estrela
- x1 Saca-rolhas
- x1 Abre-latas
- x1 Lima 25mm
- x1 Folha de serra 40mm
- x1 Folha de corte 40mm



52625

9,00€

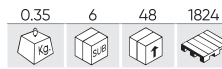

ALICATE PARA MOLAS DE TRAVÃO



51355

19,00€

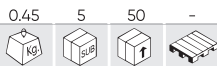

ALICATES DE EQUILÍBRIO DE PESO



52982

55,00€

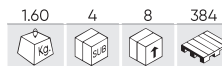

JOGO 3 MORDAÇAS DE PRESSÃO EXTRA-LARGAS



53445

17,10€

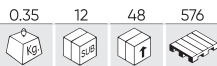

JOGO DE ALICATES PARA DESCONEXÃO DO TUBO DE COMBUSTÍVEL

- 5/16" Ø 8mm
- 3/8" Ø 10mm
- Aplicação especial



53487

16,70€

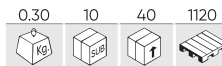

CLEȘTE PENTRU TUB DE COMBUSTIBIL



52152

13,50€

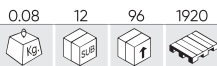

TESOURAS DE ELECTRICISTA ZEBRA



51972

12,00€

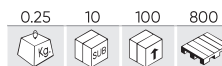

ALICATE PARA DESENCAPAR FIOS AUTO-AJUSTÁVEL

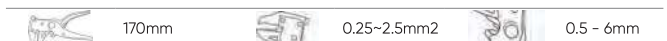

ALICATE DE CORTE DIAGONAL

REF.							€
53411	130mm	13mm	0.05	12	120	-	5,00€
53412	78mm	19mm	0.05	12	120	-	4,00€



53411



53412

CORTA CAVILHAS

REF.	"	mm					€
52955	12"	300mm	0.77	-	20	200	22,00€
52956	14"	350mm	0.95	-	20	200	22,50€
52957	18"	450mm	1.47	-	10	360	25,50€
52958	24"	600mm	2.40	-	8	210	31,50€
52959	30"	750mm	3.78	-	5	100	45,50€
52960	36"	900mm	5.15	-	5	105	49,50€



ALICATE DE CORTE PARA CABOS

REF.	mm	ø					€
53602	360mm	ø 125mm ²	0.60	-	5	300	33,00€
53603	550mm	ø 250mm ²	1.75	-	5	300	49,50€
53604	800mm	ø 500mm ²	3.70	-	5	120	128,00€



53385

19,30€



ALICATE PARA EXTRAÇÃO DE GRAMPOS DE CARROCERIA



53976

9,70€



ALICATE MULTIFUNÇÃO DE ÂNGULO RETO 6" 160MM

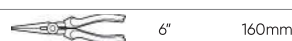

52761

8,00€

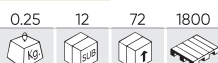

ALICATE PARA TERMINAIS ISOLADOS E NÃO ISOLADOS 9"

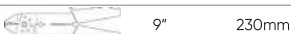

53932

8,00€



ALICATE PARA TERMINAIS PRÉ-ISOLADOS E NÃO ISOLADOS 9"

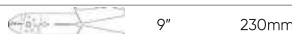

52762

9,00€

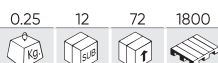

ALICATE PARA TERMINAIS NÃO ISOLADOS 8-3/4"

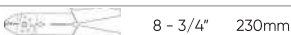

16111

21,50€

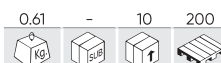

MÓDULO EVA PARA DECAPAR CABOS E TERMINAIS



54254

43,00€



ALICATE DE TERMINAIS COM PONTA INTERCAMBIÁVEL

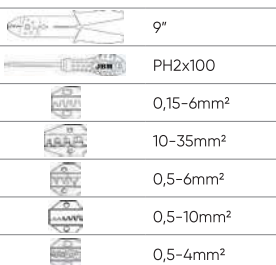

54112

18,00€

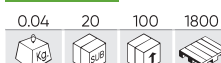

EXTRATOR DE TERMINAIS COM SEIS CONECTORES

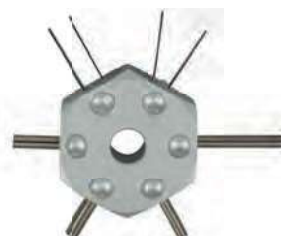

54142

15,20€

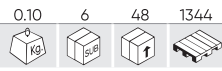

CONJUNTO DE GANCHO, PICARETA E PÉ DE CABRA (6 PCS)

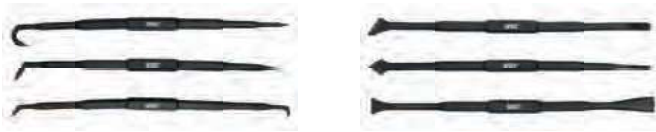

x2 Pontas de gancho

x2 Pontas anguladas

x2 Pontas retas

x6 Pontas com alavancas

51525

9,80€

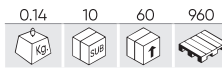

PESCA PEÇAS FLEXÍVEL COM PONTA MAGNÉTICA



500mm

Ø 7mm

51526

9,80€

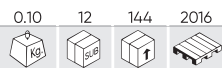

PESCA PEÇAS FLEXÍVEL COM PONTA DE 4 GARRAS



500mm

Ø 20mm

52473

9,90€

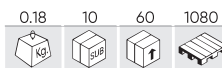

PESCA PEÇAS MAGNETICO COM LED NA PONTA



545mm

Ø 15mm

51272

7,50€

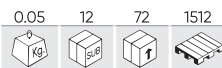

PESCA PEÇAS MAGNÉTICO COM PONTA DE LED



EM EXPOSITOR DE 12 UDS



90-810mm

Ø 18mm

52472

4,90€

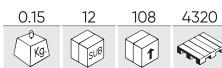

PESCA PEÇAS MAGNÉTICO EXTENSÍVEL



135-600mm

Ø 10mm

52468

5,90€

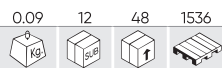

ESPELHO TELESCÓPICO ARTICULADO



280-445mm

Ø 50mm

15706

32,00€

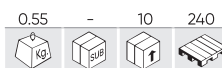

MÓDULO DE GRIP MAGNÉTICO - 5 PEÇAS



MARTELO EN CUNHA

REF.	g	mm					€
51674	505g	330mm	0.60	6	36	864	8,10€
52565	1000g	365mm	1.13	6	24	720	11,50€



MARTELO FORMA DE BOLA

REF.	g	mm					€
51504	454g	320mm	0.55	4	40	800	9,30€
51918	1000g	360mm	1.25	6	18	864	12,50€



MACHADO COM CABO DE MADEIRA

REF.	mm					€
52460	410mm	1.17	4	24	864	17,80€
52461	700mm	2.00	4	12	240	28,00€



MARTELO PROFISSIONAIS ANTI-RETROCESSO

REF.	Kg	mm					€
52180	1,35Kg	355mm	1.45	6	12	432	19,00€
52181	1,80Kg	370mm	1.81	6	12	300	22,50€
52183	2,20Kg	405mm	2.30	6	12	288	26,20€



MARTELO NYLON ANTI-RETROCESSO

REF.	ø	mm					€
52425	40mm	310mm	0.70	6	12	768	36,00€
52426	60mm	420mm	1.50	2	12	288	55,00€
52427	70mm	480mm	2.02	2	12	204	68,00€



MARTELO NYLON

REF.	ø	mm					€
14303	35mm	350mm	3.95	-	50	-	12,00€



MARTELO PROFISSIONAL CON PUNHO DE FIBRA

REF.	Kg	mm					€
52182	2Kg	297mm	2.20	6	12	504	24,00€
52184	4Kg	880mm	4.31	-	4	144	43,00€
52185	6Kg	895mm	6.97	-	4	72	60,00€
52186	8Kg	900mm	8.68	-	2	72	73,00€



52831

18,00€

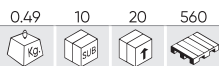

SERRA



REPOSIÇÕES
DISPONÍVEIS



EM EXPOSITOR DE 12 UDS

	98x300mm
	12" - 300mm (24T)

52786

14,60€



NAVALHA COM FUNÇÃO CORTA-CINTOS E PONTEIRA QUEBRA-VIDROS



EM EXPOSITOR DE 12 UDS

	200mm
	80mm

52878

11,20€

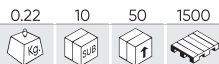

CORTA TUBOS 3-32MM



	3-32mm
--	--------

52879

10,70€

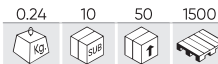

CORTA TUBOS 3-35MM



	3-35mm
--	--------

52877

16,70€

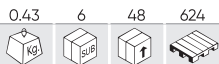

TESOURA CORTA TUBOS 42MM



	42mm
--	------

53517

9,50€

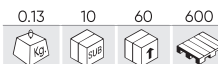

CORTA TUBOS



	30mm
--	------

54505

31,00€



CONJUNTO DE FACAS E RASPADORES

	x5	12mm
	x5	16mm
	x5	16mm
	x5	19mm
	x5	20mm
	x1	160mm
	x1	150mm



REPOSIÇÕES
DISPONÍVEIS



52885

18,80€

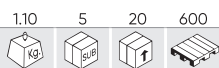

KT DE 12 VAZADORES - METRICO



3, 4, 5, 6, 7, 8, 9, 10, 12, 14, 16, 19mm

51909

2,46€

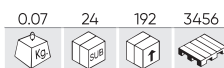

CORTADOR PROFSSIONAL



REPOSIÇÕES DISPONÍVEIS



EM EXPOSITOR DE 24 UDS

100x18mm

54331

29,50€

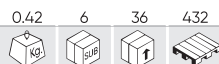

CONJUNTO DE 3 CORTADORES PROFISSIONAIS

	LÂMINA	TAMANHO LÂMINA	COMPRIMENTO
A	x4	60x19mm	175mm
B	x1	100x10mm	160mm
C	x4	60x19mm	175mm



REPOSIÇÕES DISPONÍVEIS



53083

64,00€

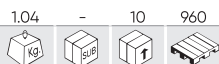

KIT DE 4 CINZÉIS



18x125, 21x150, 26x200, 29x250mm

54089

19,60€

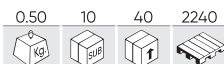

KIT DE 5 CINZÉIS



REPOSIÇÕES DISPONÍVEIS



10x155, 11x155, 12x155, 14x155, 16x155mm

ESCOPRO

REF.	mm					€
53120	150mm	0.35	6	24	1200	6,00€
53121	250mm	0.55	6	24	864	8,10€
53122	350mm	0.90	6	12	720	9,50€



53095

20,50€

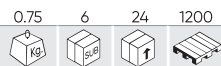

KIT DE 6 PONTEIROS

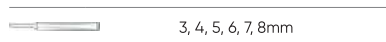

54099

14,70€

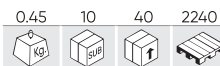

KIT DE 5 PONTEIROS

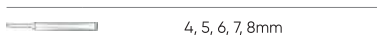

15737

48,50€

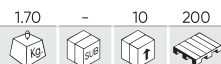

MÓDULO DE CINZÉIS E PONTEIROS



52049

14,00€

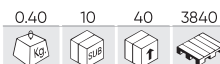

KIT DE 5 PUNÇÕES CÔNICOS

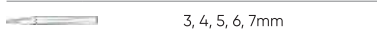

53993

85,00€

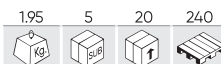

REBITADEIRA ARTICULADA MULTIFUNCCIONAL



A	x1	360°	D	x4	3/32", 1/8", 5/32", 3/16"
B	x4	M3x0.5, M4x0.7, M5x0.8, M6x1	E	x3	M4x0.7, M5x0.8, M6x1
C	x4	M3x0.5, M4x0.7, M5x0.8, M6x1	F	x3	5.5x8.5, 12x17, 15x19mm

54585

87,00€



REBITADEIRA ARTICULADA MULTIFUNCCOES



A	x1	275mm - 360°
B	x4	M3, M4, M5, M6
C	x2	Adaptadores

52595

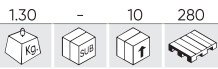

REBITADEIRA COMPACTO 200MM / 8"



8" - 200mm

M3, M4, M5, M6



66,00€

52462

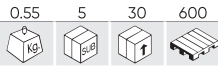

REBITADEIRA COMPACTO 200MM / 8"



8" - 200mm



2.4mm (3/32"), 3.2mm (1/8"), 4.0mm (5/32"), 4.8mm (3/16")



25,30€

52597

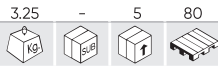

ALICATE DE REBITAR AUTOMATICO 440MM / 17"



17" - 440mm



M3, M4, M5, M6, M8, M10, M12



146,00€

52596



REBITADEIRA DE PORCA 400MM/16"



16" - 400mm



M3, M4, M5, M6, M8, M10, M12



114,00€

52463

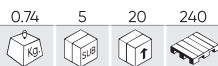

REBITADEIRA 300MM / 12"



12" - 300mm



3.2mm (1/8"), 4.0mm (5/32"), 4.8mm (3/16")



28,50€

52464

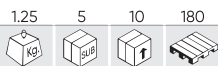

REBITADEIRA 400MM/16"



16" - 400mm



2.4mm (3/32"), 3.2mm (1/8"), 4.0mm (5/32"), 4.8mm (3/16"), 6.4mm (1/4")



42,00€

13667

19,00€

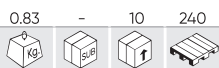

MÓDULO EVA DE REBITADEIRA E REBITES



PEÇA DE REPOSIÇÃO PARA 52595, 52596, 52597

REF.							€
13226		M3	0.03	-	100	14999	6,40€
13227		M4	0.04	20	100	-	6,40€
13228		M5	0.04	20	100	-	6,40€
13229		M6	0.04	20	100	-	6,40€

REF.							€
13230		M8	0.04	20	100	-	6,40€
13231		M10	0.05	-	100	-	6,40€
13232		M12	0.05	-	100	-	6,40€



53331

34,00€

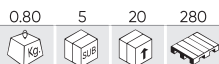

REBITADEIRA DE EMPURRAR 10" 250MM



	10" - 250mm
	2.4mm (3/32"), 3.2mm (1/8"), 4.0mm (5/32"), 4.8mm (3/16"), 6.4mm (1/4")

53332

37,00€

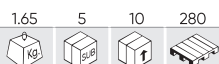

REBITADEIRA EXTENSÍVEL 8" 200MM

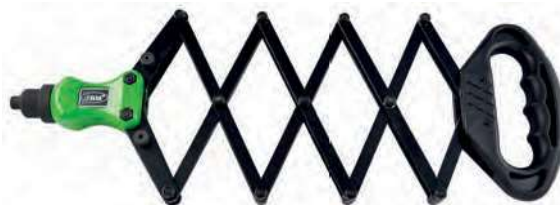

	8" - 200mm
	2.4mm (3/32"), 3.2mm (1/8"), 4.0mm (5/32"), 4.8mm (3/16"), 6.4mm (1/4")

52609

29,00€

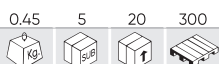

REBITADEIRA + CAIXA DE REBITES PLÁSTICOS

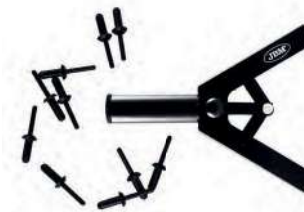

REPOSIÇÕES DISPONÍVEIS

	Ø 6.6x17.2, 6.3x25.2, 5x17.2, 5x15.8mm
--	--

119,00€

52575

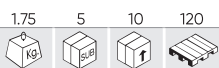

REBITADOR PNEUMÁTICO

12" - 300mm
 2.4mm (3/32"), 3.2mm (1/8"), 4.0mm (5/32"), 4.8mm (3/16")



REPOSIÇÕES DISPONÍVEIS



CINTA MÉTRICA

REF.	m	mm					€
53025	3m	16mm	0.13	12	48	2016	3,50€
53026	5m	22mm	0.26	12	48	3024	5,80€
53027	7.5m	25mm	0.40	12	48	1500	9,00€



EM EXPOSITOR DE 12 UDS

NÍVEL DE ALUMÍNIO

REF.	mm					€
53613	500mm	0.55	5	30	1260	20,50€
53614	600mm	0.60	5	30	840	23,50€
53615	800mm	0.85	5	20	600	37,00€



REPOSIÇÕES DISPONÍVEIS

NÍVEL TUBULAR MAGNETIZADO

REF.	mm					€
53616	500mm	0.30	5	60	1260	10,60€
53617	600mm	0.30	5	60	840	11,10€
53618	800mm	0.35	5	30	600	15,10€

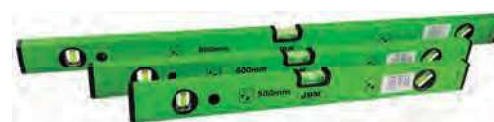

REPOSIÇÕES DISPONÍVEIS



52433 4,80€

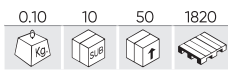

APALPA FOLGAS, -20 (0.05-1.0MM)



 0.05-1.0mm

52638 10,70€

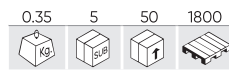

ALICATE PERFORADORA ROTATIVA



 Ø 2, 2.5, 3, 3.5, 4, 4.5mm

52318 78,00€

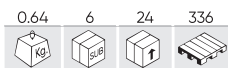

COMPROVADOR ANGULAR MAGNÉTICO



 -6/+6°

52904 61,00€







CALIBRE DE PROFUNDIDADE COM SUPORTE MAGNÉTICO







 0-10mm

PÉ DE REI

REF.	mm						€
50724	150mm	Digital	0.30	5	50	1200	28,00€
50937	150mm	Mecanico	0.24	10	50	1500	10,50€







CALIBRE DE PROFUNDIDADE

REF.	mm						€
52873	0-40mm	Mecanico	0.04	5	300	1500	11,60€
53042	0-25,4mm	Digital	0.05	10	100	2000	9,90€



GONIOMETRO

REF.	"						€
52583	1/2"		0.20	4	48	864	8,50€
52794	1/2"	Magnético	0.48	6	24	288	28,00€



51951

15,60€

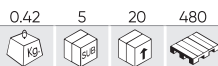

KIT DE 3 ESPÁTULAS DE AÇO



39, 65, 75mm

53339

9,50€

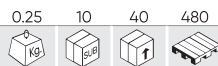

KIT DE 4 ESPÁTULAS DE AÇO



2, 3, 4, 6"

53589

12,10€

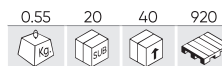

GRAMPEADOR INDUSTRIAL



REPOSIÇÕES DISPONÍVEIS



4-14mm

52700

20,50€

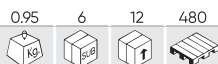

KIT DE ABOCARDADO DE TUBOS



3/16, 1/4, 5/16, 3/8, 1/2"

51853

18,00€

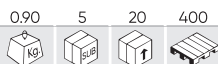

KIT DE 5 LIMAS DE AÇO



8" - 310mm

52905

28,00€

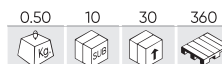

CURVA TUBOS 6-8-10MM



270mm

6, 8, 10mm

52760

4,10€

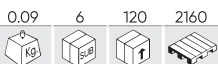

CEPILLO METÁLICO



290mm

Aço

52515

9,10€



KIT DE 3 ESCOVAS METÁLICAS



225mm

Latão, nylon e aço

51989

49,50€



KIT 38 ESCOVAS DE LIMPEZA METAL / PLÁSTICO

A	x1	
B	x1	1/4"
C	x12	8, 9, 10, 11, 12, 13, 14, 15, 16, 17, 18, 19mm
D	x12	8, 9, 10, 11, 12, 13, 14, 15, 16, 17, 18, 19mm
E	x12	8, 9, 10, 11, 12, 13, 14, 15, 16, 17, 18, 19mm



MOBÍLIA DE OFICINA

CONJUNTOS DE MÓVEIS	76	MESAS DE TRABALHO	111
CARROS DE FERRAMENTAS	80	ARMAZENAMENTO	113
CONJUNTOS DE FERRAMENTAS	95	BANCOS / ESTRADOS	117
ACESSÓRIOS	106	TORNOS/BIGORNAS	120



**NOVA GAMA
DE MOBILIÁRIO.
SISTEMA MODULAR.**



Qualidade

Um design ergonómico com acabamentos modernos de alta qualidade para manter a sua oficina organizada e otimizar o seu trabalho e o da sua equipa



Adaptabilidade

Crie o seu ambiente de trabalho a partir do zero, adaptando-o ao seu espaço e às suas necessidades com múltiplas combinações do nosso mobiliário



Organização

Mantenha a sua oficina arrumada com a ampla capacidade de arrumação proporcionada pelos nossos móveis, quer em conjunto quer individualmente



Instalação

Adapte-se às suas necessidades em constante mudança, ajustando ou expandindo o mobiliário facilmente graças ao seu processo simples de instalação e montagem



- A x1 16627 ARMÁRIO COM 4 GAVETAS
- B x1 16492 ARMÁRIO DE CANTO COM CHAPA
- C x1 16493 ARMÁRIO COM SUPORTE PARA ROLO DE PAPEL
- D x2 16494 ARMÁRIO DE PAREDE
- E x1 16491 ARMÁRIO DE CANTO
- F x4 16498 PANEL DE FERRAMENTAS
- G x1 16516 4 PEÇAS DE CAVILHAS PARA ARMÁRIO DE CANTO
- H x2 16497 PLACA
- I x2 16561 BARRA DE SUPORTE



- A x1 16627 ARMÁRIO COM 4 GAVETAS
- B x1 16628 ARMÁRIO COM 6 GAVETAS
- C x1 16500 ARMÁRIO COM 2 PORTAS
- D x3 16494 ARMÁRIO DE PAREDE
- E x6 16498 PANEL DE FERRAMENTAS
- F x1 16600 PLACA DE AÇO INOXIDÁVEL
- G x2 16561 BARRA DE SUPORTE



- A x1 16493 ARMÁRIO COM SUPORTE PARA ROLO DE PAPEL
- B x1 16627 ARMÁRIO COM 4 GAVETAS
- C x1 16490 ARMÁRIO ALTO
- D x2 16494 ARMÁRIO DE PAREDE
- E x4 16498 PANEL DE FERRAMENTAS
- F x1 16496 PLACA
- G x2 16561 BARRA DE SUPORTE

SERIE446

2.350,00€

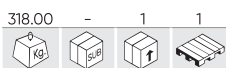

CONJUNTO DE MÓVEIS MODULARES PARA OFICINA (18 PCS) +KIT DE 4 MÓDULOS DE CARBONO EVA PARA FERRAMENTAS



OS PAINÉIS DE FERRAMENTAS SÃO COMPATÍVEIS COM OS NOSSOS GANCHOS: REF.16354, 16355, 16356, 16357



DIMENSÕES GERAIS

Altura	1950mm
Comprimento	2640mm
Largura	500mm

ACOPLAMENTO QUADRADO

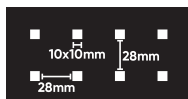

REPOSIÇÕES DISPONÍVEIS

O CARRO COM DOTAÇÃO CONTÉM:

53708

325,00€

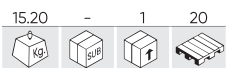

KIT DE 4 MÓDULOS DE CARBONO EVA PARA FERRAMENTAS

14296 122,00€



14297 93,00€



14298 55,00€



14299 93,00€



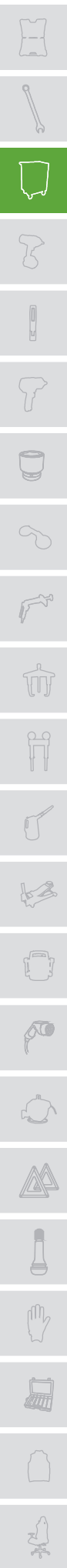

16500 463,00€

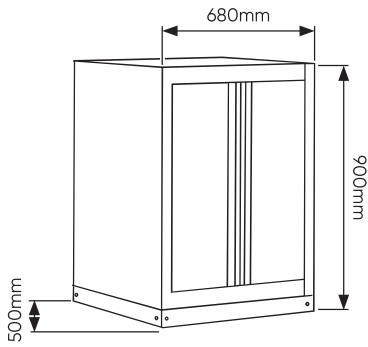

16627 537,00€

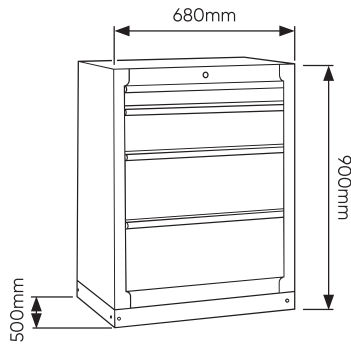
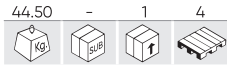

16628 594,00€

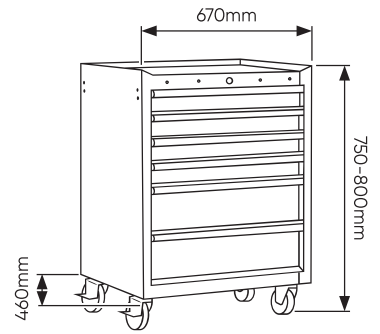
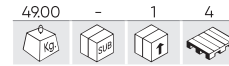

16493 463,00€

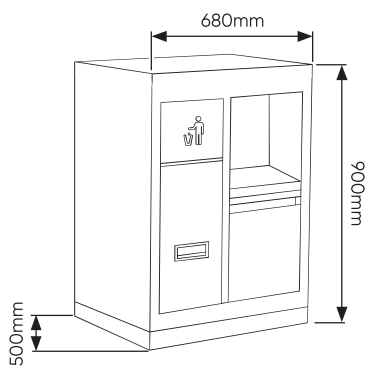
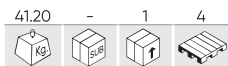

16492 675,00€

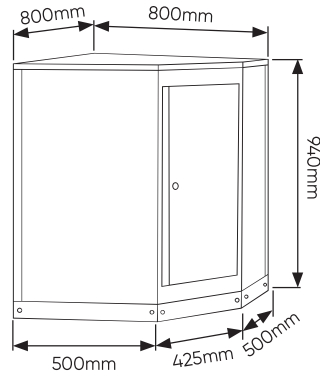
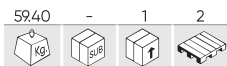

16490 650,00€

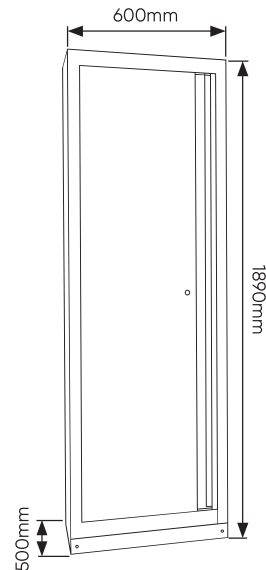
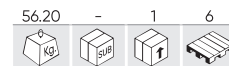

16494 139,00€

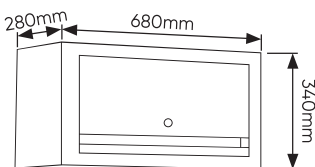
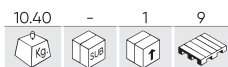

16491 298,00€

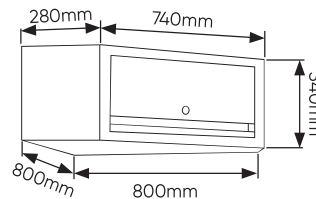
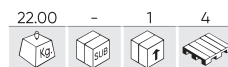

PLACAS

REF.	MATERIAL	DIMENSÕES					€
16497	Madeira	680x500x40mm	9.80	-	1	-	77,00€
*Projetado para cobrir 1 módulo							
16496	Madeira	1360x500x40mm	18.45	-	1	19	127,00€
*Projetado para cobrir 2 módulos							
16629	Madeira	2040x500x40mm	27.80	-	1	1	185,00€
*Projetado para cobrir 3 módulos							
16600	Aço inoxidável	2040x500x40mm	33.00	-	1	20	252,00€
*Projetado para cobrir 3 módulos							



PAINEL DE CANTO

REF.	MATERIAL	DIMENSÕES					€
16835	Madeira	1360x500x40mm	16.60	-	1	-	124,00€
16836	Aço inoxidável	680x500x40mm	20.00	-	1	-	219,00€



PANEL DE FERRAMENTAS

REF.	PEÇAS	DIMENSÕES					€
16498	1	338x25x680mm	2.00	-	3	180	26,00€
16516	4	225x38x775mm	2.30	-	4	108	121,00€

16498



16516

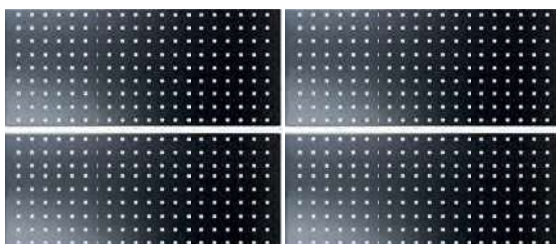

OUTROS

REF.	DESCRIÇÃO					€
16561	BARRA DE SUPORTE (REF.54327)	7.80	-	10	200	36,50€



CARROS DE FERRAMENTAS

REF.	GAVETAS	COR	EQUIPADO	PEÇAS	MATERIAL					€
53939	12		Com ferramentas	172	Aço	98.70	-	1	4	1.280,00€
53868	12		Vazio	-	Aço	83.50	-	1	4	1.090,00€

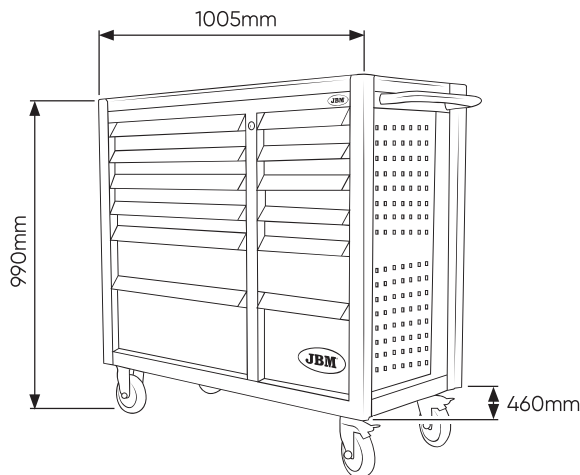

ACOPLAMENTO QUADRADO

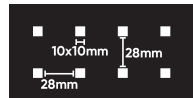

ESPECIFICAÇÕES TÉCNICAS

MEDIDAS PRIMEIRA COLUNA

Medidas gaveta pequena	75mm	533mm	400mm
Medidas gaveta média	154mm	533mm	400mm
Medidas gaveta grande	233mm	533mm	400mm
Capacidade das gavetas		35Kg	

MEDIDAS SEGUNDA COLUNA

Medidas gaveta pequena	75mm	265mm	400mm
Medidas gaveta média	154mm	265mm	400mm
Medidas gaveta grande	233mm	265mm	400mm
Capacidade das gavetas		35Kg	

O CARRO COM DOTAÇÃO CONTÉM:

53708

325,00€

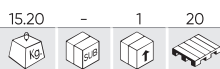

KIT DE 4 MÓDULOS DE CARBONO EVA PARA FERRAMENTAS

14296 122,00€



14297 93,00€



14298 55,00€



14299 93,00€



VER PÁGINA 106

DESCUBRA TODOS OS ACESSÓRIOS QUE TEMOS DISPONÍVEIS PARA NOSSOS CARROS DE FERRAMENTAS PARA OTIMIZAR SEU TRABALHO



CARROS DE FERRAMENTAS

REF.	GAVETAS	COR	EQUIPADO	PEÇAS	MATERIAL					€
54724	11		Com ferramentas	332	Aço	23.70	-	1	1	3.463,00€
54510	11		Vazio	-	Aço	158.00	-	1	1	1.949,50€

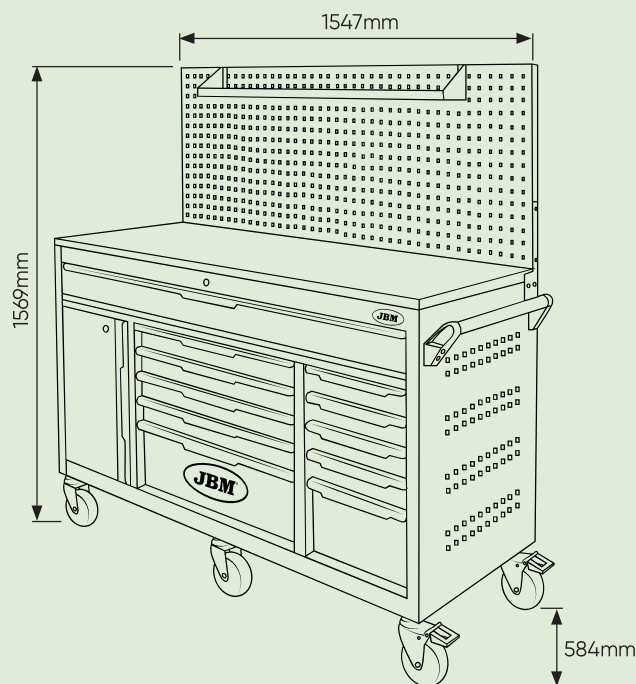

ACOPLAMENTO QUADRADO



ESPECIFICAÇÕES TÉCNICAS

MEDIDAS PRIMEIRA COLUNA

Medidas gaveta pequena	75mm	665mm	482mm
Capacidade da gaveta pequena		40Kg	
Medidas gaveta grande	206mm	665mm	482mm
Capacidade da gaveta grande		40Kg	

MEDIDAS DA GAVETA ALONGADA

Medidas da gaveta alongada	527mm	346mm	556mm
Capacidade da gaveta alongada		20Kg	

MEDIDAS SEGUNDA COLUNA

Medidas gaveta pequena	75mm	318mm	482mm
Capacidade da gaveta pequena		30Kg	
Medidas gaveta grande	206mm	318mm	482mm
Capacidade da gaveta grande		30Kg	

MEDIDAS DO ARMÁRIO

Medidas do armário	112mm	1439mm	482mm
Capacidade do armário		75Kg	

O CARRO COM DOTAÇÃO CONTÉM:

17728 445,00€



17141 369,00€ **17142** 222,00€ **17144** 385,00€



CARROS DE FERRAMENTAS

REF.	GAVETAS	COR	EQUIPADO	PEÇAS	MATERIAL					€
54723	11		Com ferramentas	331	Aço	174.50	-	1	1	3.420,00€
54509	11		Vazio	-	Aço	136.80	-	1	1	1.890,00€

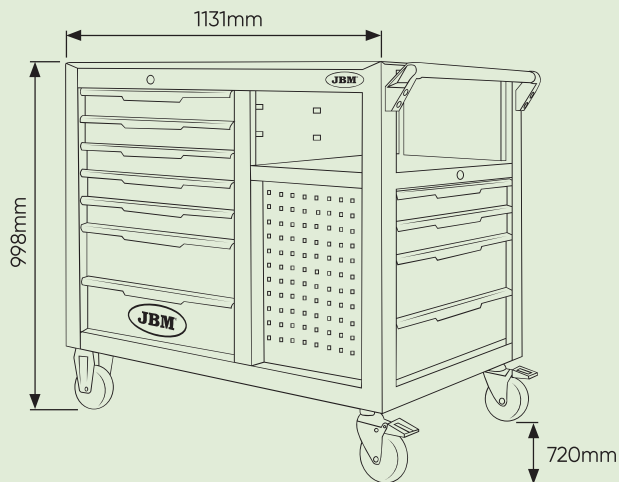

ACOPLAMENTO QUADRADO

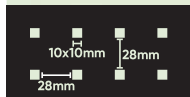

ESPECIFICAÇÕES TÉCNICAS

PARTE FRONTAL

Medidas gaveta pequena	75mm	569mm	400mm
Capacidade da gaveta pequena		35Kg	
Medidas gaveta grande	154mm	569mm	400mm
Capacidade da gaveta grande		40Kg	

PARTE LATERAL

Medidas gaveta pequena	75mm	569mm	400mm
Capacidade da gaveta pequena		35Kg	
Medidas gaveta grande	154mm	569mm	400mm
Capacidade da gaveta grande		40Kg	

O CARRO COM DOTAÇÃO CONTÉM:

14296 122,00€



14297 93,00€



14298 55,00€



14299 93,00€



15681 143,00€



15736 489,00€



15161 62,00€



15158 63,00€



15156 70,00€



CARROS DE FERRAMENTAS

REF.	GAVETAS	COR	EQUIPADO	PEÇAS	MATERIAL					€
54725	11	●	Com ferramentas	332	Aço	126.40	-	1	4	2.330,00€
54511	11	●	Vazio	-	Aço	93.00	-	1	4	1.097,00€

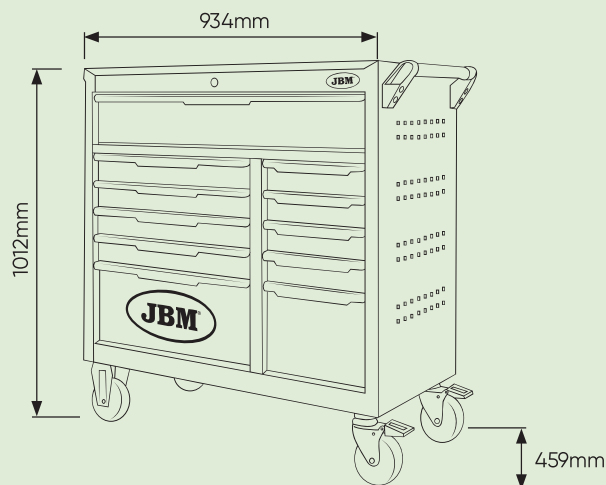

ACOPLAMENTO QUADRADO

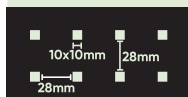

ESPECIFICAÇÕES TÉCNICAS

MEDIDAS PRIMEIRA COLUNA			
Medidas gaveta pequena	75mm	569mm	400mm
Capacidade da gaveta pequena		35Kg	
Medidas gaveta grande	233mm	569mm	400mm
Capacidade da gaveta grande		40Kg	

MEDIDAS DA GAVETA ALONGADA			
Medidas da gaveta alongada	138mm	933mm	400mm
Capacidade da gaveta alongada		40Kg	

MEDIDAS SEGUNDA COLUNA			
Medidas gaveta pequena	75mm	296mm	400mm
Capacidade da gaveta pequena		30Kg	
Medidas gaveta grande	233mm	296mm	400mm
Capacidade da gaveta grande		30Kg	

O CARRO COM DOTAÇÃO CONTÉM:

17729 445,00€



17141 369,00€ **17142** 222,00€ **17144** 385,00€



CARROS DE FERRAMENTAS

REF.	GAVETAS	COR	EQUIPADO	PEÇAS	MATERIAL						€
54718	8		Com ferramentas	289	Aço	69.00	-	1	1	1	2.060,00€
54717	8		Vazio	-	Aço	56.00	-	1	1	1	549,00€

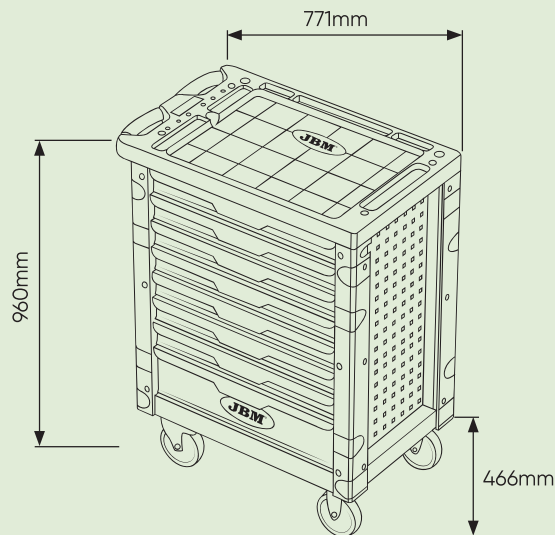

ACOPLAMENTO QUADRADO

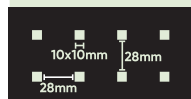

ESPECIFICAÇÕES TÉCNICAS

Medidas gaveta pequena	75mm	575mm	428mm
Medidas gaveta grande	150mm	575mm	428mm

Capacidade da gaveta pequena	35Kg
Capacidade da gaveta grande	35Kg

O CARRO COM DOTAÇÃO CONTÉM:

54720

1.549,00€

34.90	-	1	1
-------	---	---	---

CONJUNTO DE 7 TABULEIROS PARA CARRINHO DE FERRAMENTAS

CONTÉM

17138	245,00€	17139	130,00€	17140	167,00€	17141	369,00€
17142	222,00€	17143	313,00€	17144	385,00€		

CARROS DE FERRAMENTAS

REF.	GAVETAS	COR	EQUIPADO	PEÇAS	MATERIAL					€
54688	8		Com ferramentas	468	Aço	130.50	-	1	4	3.150,00€
54690	8		Vazio	-	Aço	77.50	-	1	1	988,00€



VÍDEO TUTORIAL

ACOPLAMENTO QUADRADO

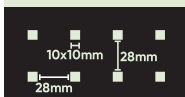

ESPECIFICAÇÕES TÉCNICAS

Medidas gaveta pequena	73mm	771mm	430mm
Medidas gaveta grande	152mm	771mm	430mm

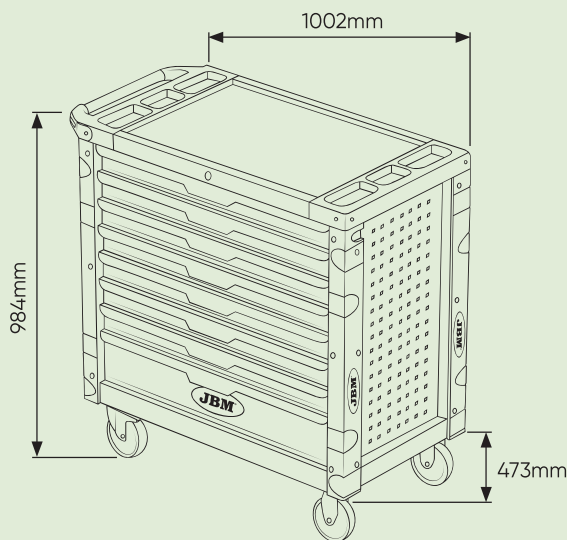

Capacidade da gaveta pequena	35Kg
Capacidade da gaveta grande	35Kg

O CARRO COM DOTAÇÃO CONTÉM:

54689

2.162,00€



KIT DE 7 MÓDULOS DE CARBONO EVA PARA FERRAMENTAS

CONTÉM

16873	145,00€	16874	454,00€	16875	433,00€	16876	369,00€
16877	290,00€	16878	174,00€	16879	315,00€		

CARROS DE FERRAMENTAS

REF.	GAVETAS	COR	EQUIPADO	PEÇAS	MATERIAL					€
53912	7	●	Com ferramentas	199	Aço	74.50	-	1	4	1.280,00€
53869	7	●	Vazio	-	Aço	74.50	-	1	4	990,00€
53913	7	●	Com ferramentas	199	Aço	74.50	-	1	4	1.280,00€
53870	7	●	Vazio	-	Aço	74.50	-	1	4	990,00€

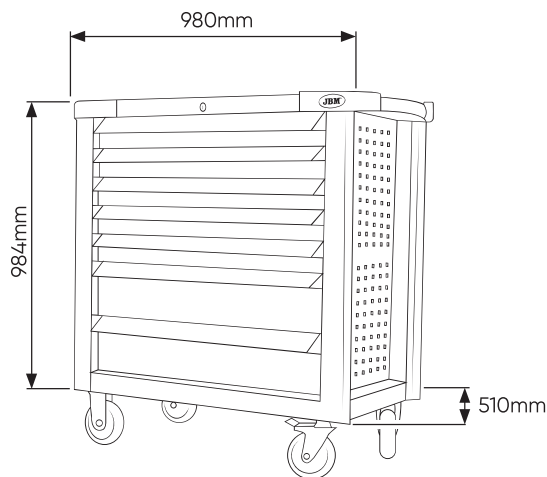

ACOPLAMENTO QUADRADO

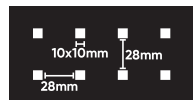

ESPECIFICAÇÕES TÉCNICAS

Medidas gaveta pequena	74mm	705mm	400mm
Medidas gaveta grande	151,5mm	705mm	400mm

Capacidade da gaveta pequena	25Kg
Capacidade da gaveta grande	35Kg

O CARRO COM DOTAÇÃO CONTÉM:

<p>14296 122,00€</p>	<p>14297 93,00€</p>	<p>14298 55,00€</p>	<p>14299 93,00€</p>
<p>15122 80,00€</p>	<p>15155 61,00€</p>	<p>15161 62,00€</p>	<p>15514 9,35€</p>

VER PÁGINA 106
 DESCUBRA TODOS OS ACESSÓRIOS QUE TEMOS DISPONÍVEIS PARA NOSSOS CARROS DE FERRAMENTAS PARA OTIMIZAR SEU TRABALHO



CARROS DE FERRAMENTAS COM 7 GAVETAS

CARROS DE FERRAMENTAS VAZIOS

REF.	GAVETAS	COR	EQUIPADO	PEÇAS	MATERIAL					€
54006	7	●	Vazio	-	Aço	55.00	-	1	4	490,00€
53762	7	●	Vazio	-	Aço	55.50	-	1	4	490,00€
53768	7	●	Vazio	-	Aço	56.00	-	1	4	490,00€
53761	7	●	Vazio	-	Aço	52.50	-	1	4	490,00€



ACOPLAMENTO QUADRADO

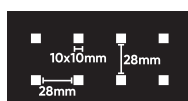

ESPECIFICAÇÕES TÉCNICAS

Medidas gaveta pequena	74mm	533mm	400mm
Capacidade da gaveta pequena		30Kg	
Medidas gaveta grande	151,5mm	533mm	400mm
Capacidade da gaveta grande		30Kg	

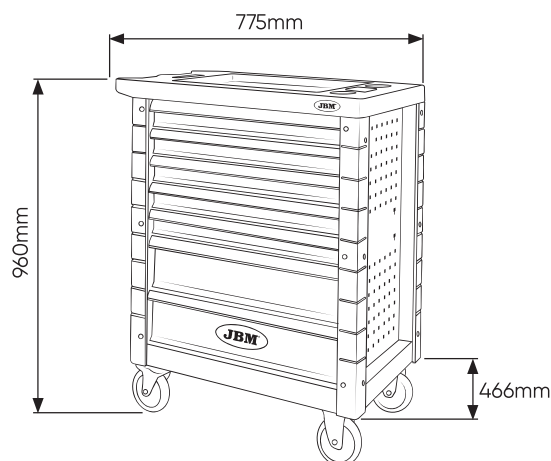

LATERAIS PERFURADOS PARA ADICIONAR ACESSÓRIOS



SEPARADOR DE FECHAMENTO INDIVIDUAL POR GAVETA



SISTEMA DE FECHAMENTO CENTRALIZADO



2 RODAS ROTATIVAS E 2 RODAS RÍGIDA



VER PÁGINA 106

DESCUBRA TODOS OS ACESSÓRIOS QUE TEMOS DISPONÍVEIS PARA NOSSOS CARROS DE FERRAMENTAS PARA OTIMIZAR SEU TRABALHO



ESCOLHA O CARRO COM OS MÓDULOS MAIS ADEQUADOS ÀS SUAS NECESSIDADES

ESPECIAL FERRAMENTAS MANUAIS

REF.	GAVETAS	COR	EQUIPADO	PEÇAS	MATERIAL					€
53904	7	●	Com ferramentas	172	Aço	65.00	-	1	4	790,00€
53686	7	●	Com ferramentas	172	Aço	65.00	-	1	4	790,00€
53767	7	●	Com ferramentas	172	Aço	65.50	-	1	4	790,00€
53661	7	●	Com ferramentas	172	Aço	65.50	-	1	4	790,00€



O CARRO COM DOTAÇÃO CONTÉM:

53708 325,00€



KIT DE 4 MÓDULOS DE CARBONO EVA PARA FERRAMENTAS

14296 122,00€



14297 93,00€



14298 55,00€



14299 93,00€



VER PÁGINA 106

DESCUBRA TODOS OS ACESSÓRIOS QUE TEMOS DISPONÍVEIS PARA NOSSOS CARROS DE FERRAMENTAS PARA OTIMIZAR SEU TRABALHO



ESCOLHA O CARRO COM OS MÓDULOS MAIS ADEQUADOS ÀS SUAS NECESSIDADES

ESPECIAL CAMINHÃO

REF.	GAVETAS	COR	EQUIPADO	PEÇAS	MATERIAL					€
54240	7	●	Com ferramentas	224	Aço	107.70	-	1	4	1.887,00€
54238	7	●	Com ferramentas	224	Aço	110.50	-	1	4	1.887,00€
54239	7	●	Com ferramentas	224	Aço	110.50	-	1	4	1.887,00€
54237	7	●	Com ferramentas	224	Aço	110.50	-	1	4	1.887,00€



O CARRO COM DOTAÇÃO CONTÉM:

54134 1.485,00€

55.50 - 1 16

MÓDULO DE FERRAMENTAS DE REPARAÇÃO DE CAMIÕES

15730 289,00€



15731 214,00€



15732 294,00€



15733 118,00€



15734 289,00€











15735 156,00€



15736 489,00€



ESPECIAL KIT DE BLOQUEIO

REF.	GAVETAS	COR	EQUIPADO	PEÇAS	MATERIAL					€
53951	7		Com ferramentas	250	Aço	94.70	-	1	4	1.794,00€
53952	7		Com ferramentas	250	Aço	94.70	-	1	4	1.794,00€
54501	7		Com ferramentas	250	Aço	94.70	-	1	4	1.794,00€
54502	7		Com ferramentas	250	Aço	94.70	-	1	4	1.794,00€



O CARRO COM DOTAÇÃO CONTÉM:

53775 1.378,00€



MÓDULO DE 6 FERRAMENTAS DE SINCRONIZAÇÃO DE MOTOR

53769 195,00€



53770 221,00€



53771 158,00€



53772 257,00€



53773 327,00€



53774 208,00€



VER PÁGINA 106

DESCUBRA TODOS OS ACESSÓRIOS QUE TEMOS DISPONÍVEIS PARA NOSSOS CARROS DE FERRAMENTAS PARA OTIMIZAR SEU TRABALHO



ESPECIAL VEÍCULOS ELÉCTRICOS

REF.	GAVETAS	COR	EQUIPADO	PEÇAS	MATERIAL					€
54236	7		Com ferramentas	23	Aço	67.70	-	1	4	1.856,00€
54234	7		Com ferramentas	23	Aço	67.70	-	1	4	1.856,00€
54235	7		Com ferramentas	23	Aço	67.70	-	1	4	1.856,00€
54233	7		Com ferramentas	23	Aço	67.70	-	1	4	1.856,00€



LATERAIS PERFURADOS PARA ADICIONAR ACESSÓRIOS



SEPARADOR DE FECHAMENTO INDIVIDUAL POR GAVETA



SISTEMA DE FECHAMENTO CENTRALIZADO



2 RODAS ROTATIVAS E 2 RODAS RÍGIDA



CONTÉM

REF.	DESCRIÇÃO	PEÇAS					€
52162	TERMÓMETRO LÁSER -50°C A 550°C	1	0.17	6	72	576	38,00€
53940	POSTE DE PLÁSTICO PARA CORRENTE - AMARELO / PRETO	4	0.55	-	6	90	15,40€
54326	CORRENTE DE PVC - 7M - AMARELO/PRETO	4	0.30	-	20	600	8,40€
53942	ELO DE FECHAR PRETO	8	0.01	50	5000	75000	0,50€
54093	MÓDULO EVA DE FERRAMENTA ISOLADA	1	2.88	-	4	80	441,00€
54114	MEDIDOR DE ISOLAMENTO	1	1.48	-	10	100	248,00€
54129	TAPETE ISOLANTE CLASSE 0	1	2.10	-	5	200	110,00€
54130	LUVAS ISOLANTES PARA TRABALHOS SOB TENSÃO T.9	1	0.35	-	1	100	58,00€
54132	PROTEÇÃO FACIAL ISOLANTE PARA TRABALHOS SOB TENSÃO	1	0.70	-	1	72	190,00€
54241	GANCHO DE RESGATE ISOLADO - 45KV	1	1.10	-	1	50	120,00€









VER PÁGINA 106

DESCUBRA TODOS OS ACESSÓRIOS QUE TEMOS DISPONÍVEIS PARA NOSSOS CARROS DE FERRAMENTAS PARA OTIMIZAR SEU TRABALHO



CARROS DE FERRAMENTAS - GAVETAS IGUAIS

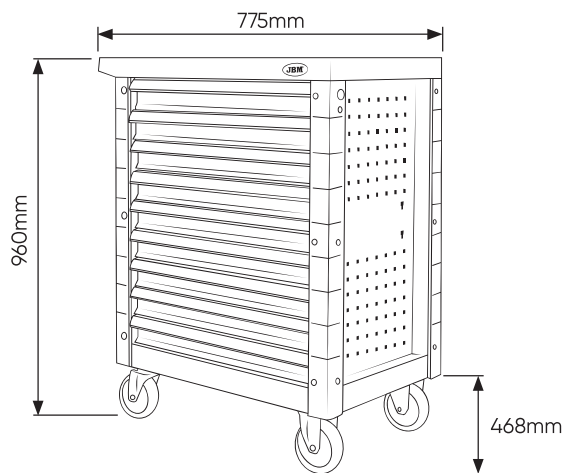

REF.	GAVETAS	COR	EQUIPADO	PEÇAS	MATERIAL					€
54295	7		Vazio	-	Aço	49,00	-	1	4	500,00€
54296	8		Vazio	-	Aço	49,00	-	1	4	520,00€
54297	9		Vazio	-	Aço	52,30	-	1	4	540,00€

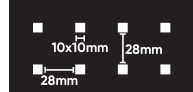

ACOPLAMENTO QUADRADO



ESPECIFICAÇÕES TÉCNICAS

			
Medidas gaveta (REF.54295)	97mm	775mm	468mm
Medidas gaveta (REF.54296)	85mm	775mm	468mm
Medidas gaveta (REF.54297)	75mm	775mm	468mm



Capacidade das gavetas (REF.54295)	25Kg
Capacidade das gavetas (REF.54296)	25Kg
Capacidade das gavetas (REF.54297)	25Kg

53867



849,00€



CARRINHO DE FERRAMENTAS COM 9 GAVETAS E SEPARADORES - VERDE

REF.	mm	UNI.			€
15073	174x53mm	21	0.05	200	1,00€
15076	396x53mm	18	0.30	50	4,60€

TAMBÉM PODE INTERESSAR...

REF.	mm			€
15070	67x53mm	0.05	200	0,69€
15071	103x53mm	0.05	200	0,82€
15072	138x53mm	0.05	200	0,94€
15074	210x53mm	0.10	200	1,35€
15075	280x53mm	0.10	200	1,75€

COM SEPARADORES
ORGANIZAÇÃO LIVRE



ACOPLAMENTO QUADRADO

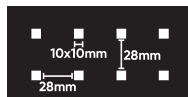

CARROS DE FERRAMENTAS

REF.	GAVETAS	COR	EQUIPADO	PEÇAS	MATERIAL					€
54389	7	●	Com ferramentas	172	Aço	64.00	-	1	4	790,00€
54503	7	●	Vazio	-	Aço	55.00	-	1	4	490,00€

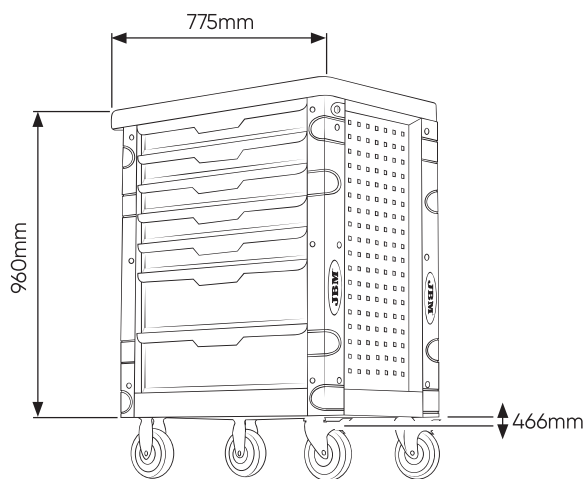

ACOPLAMENTO QUADRADO

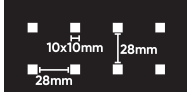

ESPECIFICAÇÕES TÉCNICAS

Medidas gaveta pequena	74mm	533mm	400mm
Medidas gaveta grande	151,5mm	533mm	400mm

Capacidade da gaveta pequena	35Kg
Capacidade da gaveta grande	35Kg

O CARRO COM DOTAÇÃO CONTÉM:

53708

325,00€

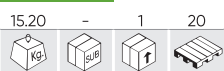

KIT DE 4 MÓDULOS DE CARBONO EVA PARA FERRAMENTAS

14296 122,00€



14297 93,00€



14298 55,00€



14299 93,00€



VER PÁGINA 106

DESCUBRA TODOS OS ACESSÓRIOS QUE TEMOS DISPONÍVEIS PARA NOSSOS CARROS DE FERRAMENTAS PARA OTIMIZAR SEU TRABALHO



CARRINHO MODULAR

REF.	GAVETAS	COR	EQUIPADO	PEÇAS	MATERIAL					€
53672	4	●	Com ferramentas	97	Aço	23.00	-	1	6	440,00€
54504	4	●	Vazio	-	Aço	15.00	-	1	7	299,00€

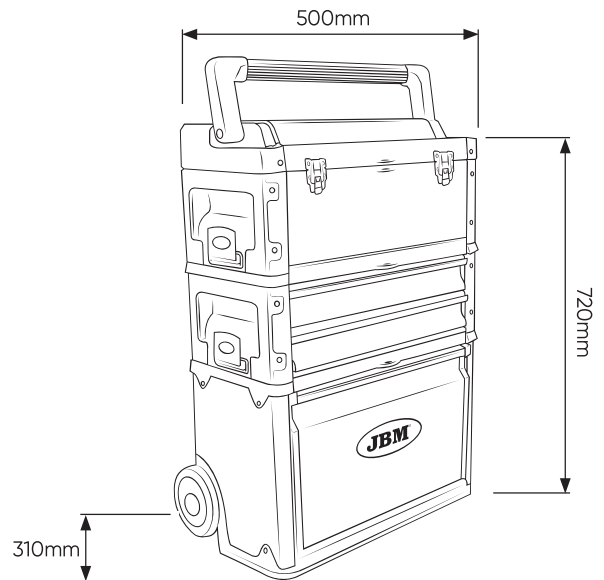

ESPECIFICAÇÕES TÉCNICAS

A Medidas primeiro módulo	240mm	500mm	310mm
B Medidas segundo módulo	170mm	500mm	310mm
C Medidas terceiro módulo	330mm	500mm	310mm

Capacidade primeiro módulo	12L
Capacidade segundo módulo	10L
Capacidade do terceiro módulo	20L

O CARRO COM DOTAÇÃO CONTÉM:

14327

204,00€

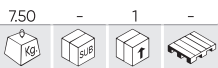

CONJUNTO DE 3 MÓDULOS DE CARBONO EVA PARA FERRAMENTAS - PARA 53672



	1/2"	x11	8, 10, 11, 12, 13, 14, 16, 17, 19, 21, 22mm
	1/4"	x13	4, 4.5, 5, 5.5, 6, 7, 8, 9, 10, 11, 12, 13, 14mm
	1/2"	x1	
	1/4"	x1	
	1/2"	x2	125, 300mm
	1/4"	x2	50, 100mm
		x1	180mm
		x1	160mm
		x2	160, 180mm
		x2	PH2x125, PH1x100mm
		x2	6x150, 5x100mm
		x9	8, 9, 10, 11, 12, 13, 14, 17, 19mm

	x1	250mm
	x1	300g
	x1	250mm
	x1	200mm
	x8	1,5x8mm
	x1	3mm
	1/4"	x32
	1/4"	x1
	1/4"	x1
	1/4"	x1
	1/2"	x1
	1/4"	x1

MÓDULOS EVA COM ACABAMENTO EM FIBRA DE CARBONO



53708

325,00€

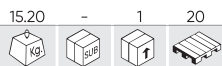

KIT DE 4 MÓDULOS DE CARBONO EVA PARA FERRAMENTAS

CONTÉM

14296

122,00€



14297

93,00€



14298

55,00€



14299

93,00€

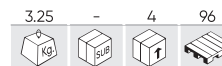

14296	
	1/2" x17 10, 11, 12, 13, 14, 15, 16, 17, 18, 19, 20, 21, 22, 24, 27, 30, 32mm
	1/4" x13 4, 4.5, 5, 5.5, 6, 7, 8, 9, 10, 11, 12, 13, 14mm
	1/2" x5 14, 15, 17, 19, 22mm
	1/4" x8 6, 7, 8, 9, 10, 11, 12, 13mm
	1/2" x8 E10, E11, E12, E14, E16, E18, E20, E24
	1/4" x5 E4, E5, E6, E7, E8
	12" x2 1/2", 1/4"
	1/2" x2 125, 250mm
	1/4" x2 50, 100mm
	x2 1/2", 1/4"
	x1 F1/2" - M3/8"
	1/2" x2 16, 21mm
	x3 1.5, 2, 2.5mm
	1/4" x1
	1/4" x1
	1/2" x1 8mm
	x2 PH1, PH2
	x2 PZ1, PZ2
	1/4" x4 3, 4, 5, 6mm
	x3 SL4, SL5.5, SL6.5
	x7 T8, T10, T15, T20, T25, T27, T30
	x2 PH3, PH4
	x2 PZ3, PZ4
	8mm x5 7, 8, 10, 12, 14mm
	x3 SL8, SL10, SL12
	x5 T40, T45, T50, T55, T60

14297	
	x8 6x7, 8x9, 10x11, 12x13, 14x15, 16x17, 18x19, 20x22mm
	x17 6, 7, 8, 9, 10, 11, 12, 13, 14, 15, 16, 17, 18, 19, 20, 21, 24mm
14298	
	x6 PH2x38, PH0x75, PH1x100, PH2x100, PH3x150, PH4x200
	x6 SL6x38, SL3x100, SL5x75, SL6x100, SL8x150, SL10x200
	x9 1.5, 2, 2.5, 3, 4, 5, 6, 8, 10mm
	x9 10, 15, 20, 25, 27, 30, 40, 45, 50mm
14299	
	x1 35mm
	x1 450g
	x1 10"
	x1 8"
	x1 8"
	x1 10"
	x1 7,5"
	x1 3m



54134

1.485,00€

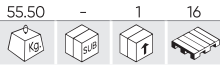

MÓDULO DE FERRAMENTAS DE REPARAÇÃO DE CAMIÕES

CONTÉM

15730 289,00€

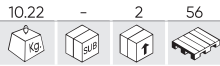

15731 214,00€

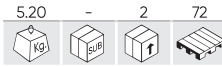

15732 294,00€

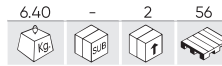

15733 118,00€

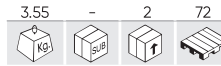

15734 289,00€

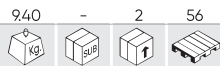

15735 156,00€

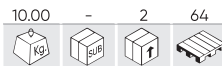

15736 489,00€

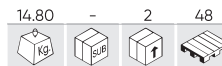

380mm

500mm

30mm

	x10	10, 11, 12, 13, 14, 15, 16, 17, 18, 19mm
	x9	E10, E11, E12, E14, E16, E18, E20, E22, E24
	x6	55mmL H5, H6, H7, H8, H10, H12
	x1	65mmL H14
	1/2"	x5 70mmL H16, H17, H18, H19, H22
		x3 50, 125, 250mm
		x1 430mm
		x1 10mm
		x1
	3/4"	x5 21, 24, 27, 34, 36mm
		x4 24, 30, 32, 36mm
	3/8"	x1 10mm
	1/4"	x3 300, 380, 450mm
		x1 150mm
		x7 H4, H5, H6, H7, H8, H10, H12
		x5 10x30mmL M5, M6, M8, M10, M12
	1/4"	x7 T20, T25, T30, T40, T45, T50, T55
		x7 H4, H5, H6, H7, H8, H10, H12
		x5 10x75mmL M5, M6, M8, M10, M12
		x7 T20, T25, T30, T40, T45, T50, T55

15731		x12	6x7, 8x9, 10x11, 12x13, 14x15, 16x17, 18x19, 20x22, 21x23, 24x27, 25x28, 30x32mm
		x13	6, 7, 8, 10, 11, 12, 13, 14, 15, 17, 19, 22, 24mm

15732		x3	10, 13, 17mm
		x3	10x11, 12x13, 14x17mm
		x3	E10xE12, E14xE18, E20xE24
		x5	8x10, 11x13, 14x15, 16x17, 18x19mm
		x4	27, 30, 32, 36mm
		x4	10, 13, 17, 19mm

15733		x6	PH0x75, PH1x75, PH2x100, PH2x38, PH3x150, PH4x200mmL
		x6	SL3.5x75, SL5x75, SL6x100, SL6x38, SL8x150, SL9.5x200mmL
		x3	10x11, 12x13, 14x15mm
		x5	10x11, 12x13, 14x15, 16x17, 18x19mm

15734		3/4"	x1 500mm
		3/4"	x1 500mm
			x1 1 Kg
		x6	24, 27, 30, 32, 36, 41mm
		x9	1, 5, 2, 2.5, 3, 4, 5, 6, 8, 10mm

15735		1/2"	x10 78mmL 13, 14, 15, 16, 17, 18, 19, 21, 22, 24mm
		3/4"	x9 78mmL 22, 24, 27, 30, 32, 33, 36, 38, 46mm
		1/2"	x2 90mmL 51, 60mm
		1/2"	x6 90mmL T40, T45, T50, T55, T60, T70
		1/2"	x4 78mmL H6, H8, H14, H17
		3/4"	x3 100mmL T80, T90, T100
		1/2"	x1 40mmL M18
			x1 1/2"(M)x3/4"(H)
			x1 3/4"(M)x1/2"(H)
			x1 125mm
		1/2"	x1
		3/4"	x1

15736		x1	330mm-90°		x1	300mm
		x1	330mm		x1	160mm
		x1	330mm-90°		x1	180mm
		x1	330mm		x1	220mm
		x1	300mm - 45°		x1	250mm
		x1	300mm - 90°			

17728

445,00€

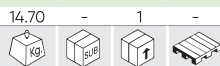

TABULEIRO COMPLETO PARA GAVETA SUPERIOR 54510

CONTÉM



REPOSIÇÕES
DISPONÍVEIS

17729

445,00€

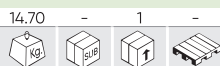

MÓDULO DE FERRAMENTAS COMPLETO PARA REF. 54511

CONTÉM



REPOSIÇÕES
DISPONÍVEIS

	1/2"	x17	10, 11, 12, 13, 14, 15, 16, 17, 18, 19, 20, 21, 22, 24, 27, 30, 32mm
	1/4"	x13	4, 4.5, 5, 5.5, 6, 7, 8, 9, 10, 11, 12, 13, 14mm
	1/2"	x5	14, 15, 17, 19, 22mm
	1/4"	x8	6, 7, 8, 9, 10, 11, 12, 13mm
	1/2"	x8	E10, E11, E12, E14, E16, E18, E20, E24
	1/4"	x5	E4, E5, E6, E7, E8
	1/2"	x2	1/2", 1/4"
	1/2"	x2	125, 250mm
	1/4"	x2	50, 100mm
		x2	1/2", 1/4"
		x1	F1/2" - M3/8"
	1/2"	x2	16, 21mm
		x3	1.5, 2, 2.5mm
	1/4"	x1	
	1/4"	x1	
	1/2"	x1	8mm
		x2	PH1, PH2
		x2	PZ1, PZ2
	1/4"	x4	3, 4, 5, 6mm
		x3	SL4, SL5.5, SL6.5
		x7	T8, T10, T15, T20, T25, T27, T30
		x2	PH3, PH4
		x2	PZ3, PZ4
	8mm	x5	7, 8, 10, 12, 14mm
		x3	SL8, SL10, SL12
		x5	T40, T45, T50, T55, T60

	x8	6x7, 8x9, 10x11, 12x13, 14x15, 16x17, 18x19, 20x22mm
	x17	6, 7, 8, 9, 10, 11, 12, 13, 14, 15, 16, 17, 18, 19, 20, 21, 24mm
	x6	PH2x38, PH0x75, PH1x100, PH2x100, PH3x150, PH4x200
	x6	SL6x38, SL3x100, SL5x75, SL6x100, SL8x150, SL10x200
	x9	1.5, 2, 2.5, 3, 4, 5, 6, 8, 10mm
	x9	10, 15, 20, 25, 27, 30, 40, 45, 50mm
	x1	35mm
	x1	450g
	x1	10"
	x1	8"
	x1	8"
	x1	10"
	x1	7,5"
	x1	3m

54689

2.162,00€

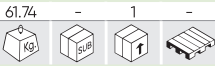

KIT DE 7 MÓDULOS DE CARBONO EVA PARA FERRAMENTAS

CONTÉM

16873 145,00€

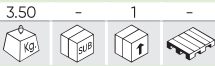

16874 454,00€

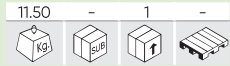

16875 433,00€

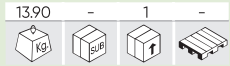

16876 369,00€

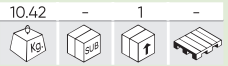

16873

	x4	PH0×75, PH1×100, PH2×125, PH3×150mm
	x6	SL3×75, SL3.5×75, SL4×100, SL5.5×125, SL6.5×150, SL8×200mm
	x12	T5×100, T6×100, T7×100, T8×100, T9×100, T10×100, T15×100, T20×100, T25×100, T27×100, T30×100, T40×100mm
	x2	6×100, 8×128mmL
	x2	1/4"x115, 5/16"x115mmL
	x2	132mmL
	x1	11×200, 16×300mmL
	x1	
	x1	
	x1	

16874

	x12	4, 4.5, 5, 5.5, 6, 7, 8, 9, 10, 11, 12, 13mm
	x12	4, 4.5, 5, 5.5, 6, 7, 8, 9, 10, 11, 12, 13mm
	x6	E4, E5, E6, E7, E8, E10
	x6	E4, E5, E6, E7, E8, E10
	x3	50, 100, 150mmL
	x1	1/4"
	x1	3/8"(F) x 1/4"(M)
	1/4"	x1 1/4"
	x7	H3, H4, H5, H6, H7, H8, H10
	x3	PH0, PH1, PH2
	x3	PZ0, PZ1, PZ2
	x3	SL4, SL5.5, SL6
	x7	IPR10, IPR15, IPR20, IPR25, IPR27, IPR30, IPR40
	x8	T8, T10, T15, T20, T25, T27, T30, T40
	x8	T8H, T10H, T15H, T20H, T25H, T27H, T30H, T40H
	x4	45, 75, 150, 250mm
	x1	1/2"(F) x 3/8"(M)
	x3	16, 18, 21mm

	x3	
	x1	
	x17	6, 7, 8, 9, 10, 11, 12, 13, 14, 15, 16, 17, 18, 19, 20, 21, 22mm
	x17	6, 7, 8, 9, 10, 11, 12, 13, 14, 15, 16, 17, 18, 19, 20, 21, 22mm
	x10	E4, E5, E6, E7, E8, E10, E11, E12, E14, E16
	x10	E4, E5, E6, E7, E8, E10, E11, E12, E14, E16
	x3	PH1, PH2, PH3
	x3	PZ1, PZ2, PZ3
	x3	SL5.5, SL6, SL7
	x10	H3, H4, H5, H5.5, H6, H7, H8, H9, H10, H12mm
	x12	T8, T10, T15, T20, T25, T27, T30, T40, T45, T50, T55, T60
	x12	T8H, T10H, T15H, T20H, T25H, T27H, T30H, T40H, T45H, T50H, T55H, T60H
	x6	M5, M6, M8, M9, M10, M12
	x8	R4, R5, R6, R7, R8, R9, R10, R12
	x3	
	x1	
	x1	20-120Nm
	x1	UNIVERSAL
	x1	450mmL
	x1	250mmL

16875

	x22	8, 9, 10, 11, 12, 13, 14, 15, 16, 17, 18, 19, 20, 21, 22, 23, 24, 26, 27, 28, 30, 32mm
	x22	8, 9, 10, 11, 12, 13, 14, 15, 16, 17, 18, 19, 20, 21, 22, 23, 24, 26, 27, 28, 30, 32mm
	x8	E10, E11, E12, E14, E16, E18, E20, E24
	x8	E10, E11, E12, E14, E16, E18, E20, E24
	x6	H5, H6, H7, H8, H10, H12 - 100mmL
	x4	T40, T45, T50, T55 - 100mmL
	x5	M6, M8, M10, M12, M14 - 100mmL
	x3	17, 19, 21mm
	x1	20-200Nm



ORGANIZAÇÃO E EFICIÊNCIA

Descubra nossos módulos de ferramentas, projetados para se integrar perfeitamente aos nossos carrinhos. A solução ideal para profissionais que priorizam a praticidade e a eficiência em cada tarefa.

54689

2.162,00€

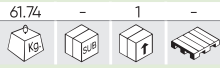

KIT DE 7 MÓDULOS DE CARBONO EVA PARA FERRAMENTAS

CONTÉM

16877 290,00€

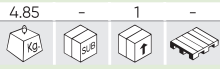

16878 174,00€

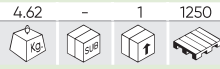

16879 315,00€

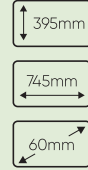
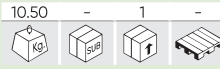

	x1	255mm
	x2	125, 250mmL
	x1	380mmL
	x1	UNIVERSAL
16876		
	x26	6, 7, 8, 9, 10, 11, 12, 13, 14, 15, 16, 17, 18, 19, 20, 21, 22, 23, 24, 25, 26, 27, 28, 29, 30, 32mm
	x8	6×7, 8×9, 10×11, 12×13, 14×15, 16×17, 18×19, 20×22
	x7	6×7, 8×9, 10×11, 12×13, 14×15, 16×17, 18×19
	x12	8, 9, 10, 11, 12, 13, 14, 15, 16, 17, 18, 19mm
16877		
	x4	7"
	x3	7" (x1), 8" (x2)
	x1	7"
	x1	10"
	x1	10"
	x1	5m
	x1	10"
	x1	
	x1	
	x1	
	x1	
	x1	
	x3	
	x1	
	x10	
	x1	
	x1	
	x1	
	x1	

16878		
	x4	8"
	x9	H1.5, 2, 2.5, 3, 4, 5, 6, 8, 10
	x9	T10, 15, 20, 25, 27, 30, 40, 45, 50
	x10	4, 5, 5.5, 6, 8, 9, 10, 11, 12, 13mm
	x1	7mm
	x8	H2, H2.5, H3, H4, H5, H6, H7, H8
16879		
	x22	10, 11, 12, 13, 14, 15, 16, 17, 18, 19, 20, 21, 22, 23, 24, 25, 26, 27, 28, 29, 30, 32mm
	x1	1/2"
	x1	125mmL
	x4	140mmml 10, 160mmml 12, 190mmml 18, 220mmml 24
	x1	190mmml 7
	x4	150mmml 3, 180mmml 4, 200mmml 5, 210mmml 6
	x3	185mmml 2, 185mmml 3, 185mmml 4
	x1	185mmml 4
	x1	505gr
	x1	1106gr
	x1	608gr

CONSULTE O DESPIECE DOS NOSSOS MÓDULOS DE FERRAMENTAS!

Aceda ao despiece completo de cada um dos nossos módulos de ferramentas para poder identificar facilmente cada componente.



54720

1.549,00€

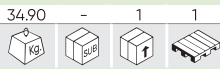

CONJUNTO DE 7 TABULEIROS PARA CARRINHO DE FERRAMENTAS

CONTÉM

17138 245,00€

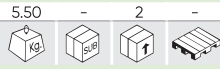

17138

	x19	6, 7, 8, 9, 10, 11, 12, 13, 14, 15, 16, 17, 18, 19, 20, 21, 22, 23, 24mm
	x8	6x7, 8x9, 10x11, 12x13, 14x15, 16x17, 18x19, 21x23mm
	x6	E6x8, E7x11, E10x12, E14x18, E16x22, E20x24
	x6	8x9, 10x11, 12x13, 14x15, 16x17, 18x19mm
	x2	10x11, 12x13mm

17139

	x9	
	x9	
	x5	PH0x75, PH1x100, PH2x125, PH2x38, PH3x150
	x5	SL4x100, SL5.5x125, SL6.5x150, SL6x38, SL8x200
	x9	T8, T9, T10, T15, T20, T25, T27, T30, T40
	x4	6, 7, 8, 10mm

17140

	x2	160mm (Internal)
	x2	160mm (External)
	x4	160, 180, 200, 210mm
	x1	0.05-1 mm
	x4	200mm
	x1	235mm
	x1	220mm
	x1	5m
	x1	18mm
	x10	0,5x18x100mm
	x1	240mm

17141

	x9	3/8", 5/16", 7, 8, 10, 11, 12, 13, 14mm
	x1	10mm
	x6	8, 9, 10, 12, 14, 17mm

17139 130,00€

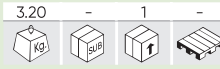

17140 167,00€

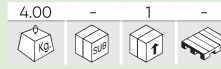

17141 369,00€

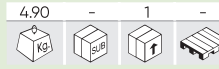

	x1	M16
	x1	10mm
	x1	10mm
	x2	14, 19mm
	x4	27, 32, 36, 74mm
	x5	15, 17, 19, 21, 22mm
	x1	162mm
	x1	
	x1	270mm
	x1	22mm
	x1	Ø65-125mm
	x1	50-125mm
	x2	Ø4, 5mm
	x1	175mm
	x2	
	x1	250mm

17142

	x1	150-675mm
	x1	510mm
	x1	85Lm
	x1	1000g
	x1	400g
	x1	400g
	x4	Ø 3, 4, 5, 6mm
	x5	Ø 3, 4, 5, 6, 8mm
	x3	7, 18 20mm
	x1	25x200mm
	x1	225mm
	x1	195x30mm



ORGANIZAÇÃO E EFICIÊNCIA

Descubra nossos módulos de ferramentas, projetados para se integrar perfeitamente aos nossos carrinhos. A solução ideal para profissionais que priorizam a praticidade e a eficiência em cada tarefa.

54720

1.549,00€

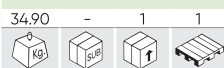

CONJUNTO DE 7 TABULEIROS PARA CARRINHO DE FERRAMENTAS

CONTÉM

17142 222,00€

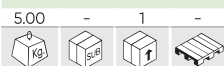

17143 313,00€



17144 385,00€



395mm

525mm

60mm

x1 370mm

17143	
	x19 10, 11, 12, 13, 14, 15, 16, 17, 18, 19, 20, 21, 22, 24, 26, 27, 28, 30, 32mm
	1/2" x2 120, 250mm
	x1
	x1
	x7 TS10, TS15, TS20, TS25, TS27, TS30, TS40
	x1 PH2
	x1 SL5.5
	x5 H3, H4, H5, H6, H7
	1/4" x7 T10, T15, T20, T25, T27, T30, T40
	x7 T10H, T15H, T20H, T25H, T27H, T30H, T40H
	x10 4, 5, 6, 7, 8, 9, 10, 11, 12, 13mm
	x2 50, 100mm
	x2
	x1
	x6 8, 9, 10, 12, 14, 16mm
	x12 8, 9, 10, 11, 12, 13, 14, 15, 16, 17, 18, 19mm
	x12 8, 9, 10, 11, 12, 13, 14, 15, 16, 17, 18, 19mm
	3/8" x2
	x2 75, 150mm
	x3 16, 18, 21mm
	x1
	x3 3/8"Fx1/4"M, 1/2"Fx3/8"M, 3/8"Fx1/2"M
	3/8" x1 14mm
	x1 250mm
	x2 235, 265mm

17144

		x19 H10 (140mm), H5, H6, H7, H8, H10, H12, H14 (100mm), H6 (240mm), H5, H6, H7, H8, H9, H10, H12, H14, H17, H19
		x5 R7, R8 (240mm), R10 (140mm), R9, R10 (100mm)
		x13 M5, M6, M8, M9, M10, M12, M14, M16 (55mm), M6, M8, M10, M12, M14 (100mm)
	1/2"	x19 T25, T27, T30, T40, T45, T50, T55, T60, T70 (100mm), T25, T27, T30, T40, T45, T50, T55, T60, T70 (140mm), T70
		x1 M18 (78mm)
		x6 13, 14, 15, 17, 19, 21mm
		x9 E10, E11, E12, E14, E16, E18, E20 E22, E24,
		x1
		1/4" x5 6, 8, 10, 11, 12mm
		x31
		x2

CONSULTE O DESPIECE DOS NOSSOS MÓDULOS DE FERRAMENTAS!

Aceda ao despiece completo de cada um dos nossos módulos de ferramentas para poder identificar facilmente cada componente.



15681

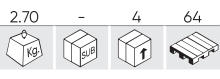

- x3 1/2", 3/8" (8mm), 1/4" (6mm)
- x5 7, 8, 10, 12, 14mm
- x2 PH3, PH4
- x2 PZ3, PZ4
- x3 SL8, SL10, SL12
- x6 T40, T45, T50, T55, T60, T70
- x6 T40, T45, T50, T55, T60, T70

143,00€

- x9 H7 (230mmL), H10, H11, H13 (140mmL), H14, H17, H19, H22, H24 (55mmL)
- x6 M9 (100mmL), M10, M12, M14 (140mmL), M16 (53mmL), M16 (100mmL)
- x4 R7, R8 (240mmL), R9 (100mmL), R10 (140mmL)
- x8 T30 (300mmL), T40, T45, T50, T55, T60, T70 (140mmL), T80 (100mmL)
- x1 HT5 (160mmL)
- x1 M18
- x6 H3, H4, H5, H6, H7, H8
- x3 M8, M10, M12
- x4 PH0, PH1, PH2, PH3
- x4 PZ0, PZ1, PZ2, PZ3
- x4 SL4, SL5.5, SL6.5, SL7
- x9 T8, T9, T10, T15, T20, T25, T27, T30, T40
- x9 T8, T9, T10, T15, T20, T25, T27, T30, T40
- x9 TS10, TS15, TS20, TS25, TS27, TS30, TS40, TS45, TS50

15158

63,00€

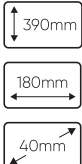
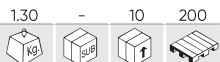

- x7 8, 10, 11, 13, 14, 17, 19mm

15159

44,00€

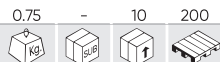

- x5 8x10, 11x13, 14x15, 17x19, 20x22mm

15160

45,00€

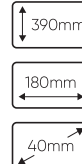

- x6 8x9, 10x11, 12x13, 14x15, 16x17, 18x19mm

15161

62,00€

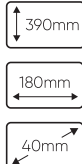

- x4 27, 29, 30, 32mm

15316

58,00€

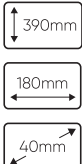
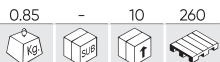

- x3 8, 9, 10, 11, 12, 13, 14, 15, 16, 17, 18, 19mm

53943

21,50€

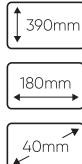
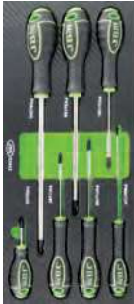
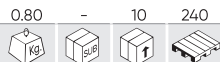

- x7 PH0x120, 1x80, 1x100, 2x38, 2x100, 3x150, 4x200

53944

19,50€



- x7 SL4x125, 5x80, 5x100, 6x38, 6x100, 8x150, 9x200

53945

18,90€

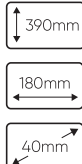

- x7 T8x75, 9x75, 10x75, 15x75, 20x75, 25x100, 27x100

15454

35,40€

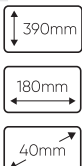

- x4 8"

15541

29,50€

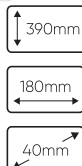
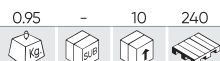

- x3 180, 200, 200mm

15122

80,00€

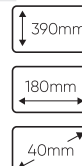

- x12 8, 9, 10, 11, 12, 13, 14, 15, 16, 17, 18, 19mm

15155

61,00€

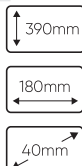

- x11 8, 10, 11, 12, 13, 14, 15, 16, 17, 18, 19mm

15315 30,00€

1.05 - 10 260

390mm
180mm
40mm

x5 8"

15514 9,35€

0.05 - 10 360

390mm
180mm
40mm

VAZIO

15156 70,00€

2.05 - 10 180

390mm
180mm
40mm

x4 21x23, 24x27, 25x28, 30x32mm

15157 42,00€

0.95 - 10 200

390mm
180mm
40mm

x6 6x8, 10x12, 13x14, 15x17, 19x21, 22x24mm

16111 21,50€

0.61 - 10 200

390mm
180mm
40mm

x1 220mm

15799 31,00€

1.35 - 10 200

390mm
180mm
40mm

x1 35mm x1 450g

13667 19,00€

0.83 - 10 240

175mm
385mm
35mm

x1 253mm

51448 52,00€

2.38 - 5 270

120mm
530mm
30mm

x5 50, 125, 250, 380, 510mm

51805 17,00€

0.33 4 20 640

97mm
225mm
34mm

x5 50, 75, 100, 152, 227mm

51447 16,00€

0.34 5 20 960

95mm
225mm
34mm

x5 50, 75, 100, 152, 227mm

52912 94,00€

1.62 - 10 240

390mm
180mm
40mm

x6 E6x7, 8x10, 11x12, 14x16, 18x20, 22x24

54066 83,00€

2.00 - 5 175

390mm
180mm
40mm

x7 8, 10, 12, 13, 14, 17, 19mm

51864 64,00€

1.87 - 10 180

490mm
190mm
34mm

x6 10x11, 12x14, 13x15, 16x18, 17x19, 22x24mm

54032 84,00€

1.45 - 10 240

380mm
175mm
32mm

x7 8, 9, 10, 11, 12, 13, 14, 15, 16, 17, 18, 19mm

53979 38,00€

1.00 - 10 180

345mm
390mm
45mm

x8 T10x75, T15x75, T20x100, T25x100, T30x150, T40x150, T45x200, T50x200

53980 38,00€

1.00 - 10 180

345mm
390mm
45mm

x8 H2x100, H2.5x100, H3x100, H4x150, H5x150, H6x200, H8x200, H10x200

15706

32,00€

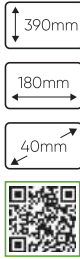
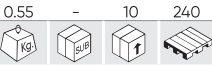

- x1 280 - 870mm
- x1 180 - 770mm
- x1 495mm
- x1 170 - 580mm
- x1 130 - 640mm



54158

38,00€

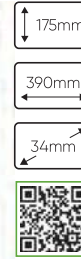

- x7 H4, H5, H6, H7, H8, H10, H12
- x5 30mmL M5, M6, M8, M10, M12
- x8 T20, T25, T30, T40, T45, T50, T55, T60
- x7 70mmL H4, H5, H6, H7, H8, H10, H12
- x5 M5, M6, M8, M10, M12
- x8 T20, T25, T30, T40, T45, T50, T55, T60
- x2 1/2", 3/8"



15737

48,50€

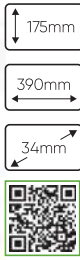
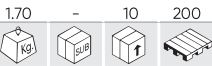

- x3 12x160, 16x175, 19x180mm
- x1 6x180mm
- x3 6x180, 8x180, 10x180mm
- x2 8x180, 10x180mm



15084

68,00€

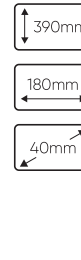

- x2 5/16", 3/8"
- x7 7, 8, 10, 11, 12, 13, 14mm
- x1 10mm
- x1 10mm
- x7 8, 9, 10, 12, 13, 14, 17mm
- x1 T45
- x1 M16
- x1 200mm
- x1 150mm



54481

113,00€

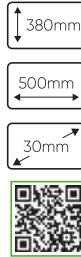

- 7, 8, 9, 10, 13, 17, 19mm (555mm)



15162

32,50€

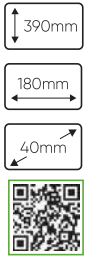
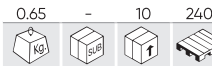

- x4 SL3x75, SL4x100, SL5.5x125, SL 6.5x150mm
- x3 PH0x75, PH1x80, PH 2x100mm
- x1 140mm



54093

441,00€

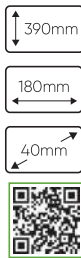
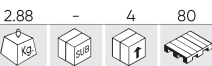

- x10 8, 10, 11, 12, 13, 14, 16, 17, 19, 22mm (3/8" - 45mm)
- x2 4x100, 5,5x125mmL
- x2 PH1x80, PH2x100mmL
- x6 7x86, 8x99, 10x109, 12x127, 14x141, 17x156mmL
- x1 160mm
- x1 110mm
- x1 185mm
- x1 200mm
- x1 125mm



MÓDULOS EVA



MÓDULOS DE PLÁSTICO

11996 54,00€

2.10 - 10 300

175mm
390mm
35mm

x10 6x7, 8x9, 10x11, 12x13, 14x15, 16x17, 18x19, 20x22, 24x27, 30x32mm

11997 42,00€

1.92 - 10 360

175mm
390mm
35mm

x8 6x7, 8x9, 10x11, 12x13, 14x15, 16x17, 18x19, 20x22mm

11998 59,00€

1.96 - 10 300

175mm
390mm
35mm

x17 6, 7, 8, 9, 10, 11, 12, 13, 14, 15, 16, 17, 18, 19, 20, 21, 22mm

53671 41,00€

0.85 - 10 520

390mm
180mm
40mm

11994 39,50€

0.77 - 10 233

390mm
180mm
40mm

13668 20,50€

0.61 - 10 300

390mm
180mm
40mm

53620 99,00€

3.52 - 4 112

390mm
525mm
30mm

x17 6, 7, 8, 9, 10, 11, 12, 13, 14, 15, 16, 17, 18, 19, 20, 21, 22mm

x8 6x7, 8x9, 10x11, 12x13, 14x15, 16x17, 18x19, 20x22mm

14114 21,00€

0.93 - 10 360

175mm
390mm
35mm

10732 20,50€

0.70 - 10 220

175mm
390mm
35mm

10735 22,50€

0.98 - 10 300

175mm
390mm
35mm



54758

17,50€

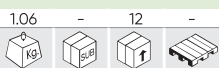

DISPENSADOR DE LUVAS MAGNÉTICAS



Compatível com
Versões atuais dos carrinhos

54759

24,00€

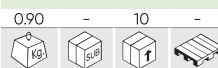

SISTEMA ORGANIZADOR DE ENCAIXES MAGNÉTICOS, 38PCS



Compatível com
Versões atuais dos carrinhos

15068

15,20€



SUPORE DE ROLO DE PAPEL PARA CARRINHO DE FERRAMENTAS



Compatível com
Versões atuais dos carrinhos

15069

35,00€



PORTA DOCUMENTOS PARA CARRO DE FERRAMENTAS



Compatível com
Versões atuais dos carrinhos

15313

14,00€



PORTA SPRAYS PARA CARROS DE FERRAMENTAS



Compatível com
Versões atuais dos carrinhos

14354

14,00€

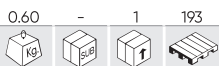

PORTA SPRAYS PARA CARROS DE FERRAMENTAS



Compatível com
Versões atuais dos carrinhos

16359

10,00€

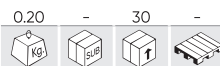

SUPORE DE BROCAS PARA CARRINHO DE FERRAMENTAS



Compatível com
Versões atuais dos carrinhos

16361

16,50€



SUPORE DE PULVERIZAÇÃO PARA CARRINHO DE FERRAMENTAS



Compatível com
Versões atuais dos carrinhos

16362

20,50€

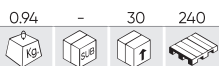

PRATELEIRA PARA CARRINHO DE FERRAMENTAS



Compatível com
Versões atuais dos carrinhos

16363

14,50€

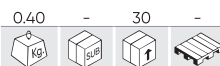

SUPORE PARA CANETA PARA CARRINHO DE FERRAMENTAS



Compatível com
Versões atuais dos carrinhos

16344

43,50€

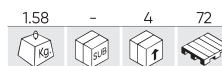

CAIXOTE DE LIXO MANEJÁVEL DE ESCRITÓRIO

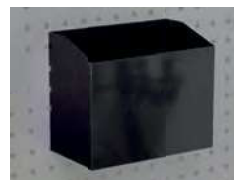

Compatível com
Versões atuais dos carrinhos

16358 12,00€

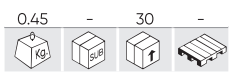

CHAVE DE FENDAS DE GANCHO ESPECIAL

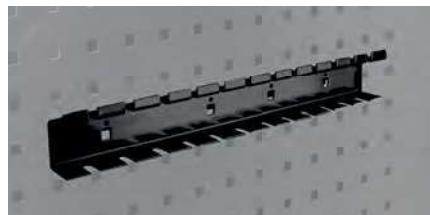

Compatível com
Versões atuais dos carrinhos

16360 12,00€

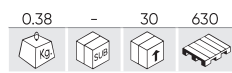

CHAVES DE GANCHO ESPECIAIS PARA CARRINHO DE FERRAMENTAS



Compatível com
Versões atuais dos carrinhos

16161 19,70€



SUPOORTE DE ROLO DE PAPEL PARA CARRINHO DE FERRAMENTAS



Compatível com
Versões antigas dos carrinhos

16162 38,50€



PORTA DOCUMENTOS PARA CARRO DE FERRAMENTAS



Compatível com
Versões antigas dos carrinhos

16163 12,10€



PORTA SPRAYS E ACESSÓRIOS PARA CARROS DE FERRAMENTAS



Compatível com
Versões antigas dos carrinhos







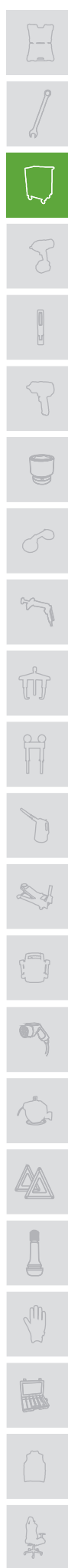
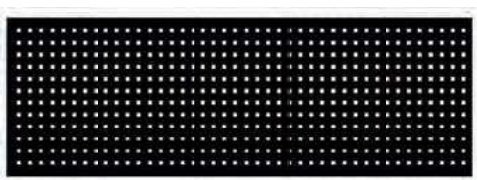

PAINEL PARA FERRAMENTAS

REF.	mm	■	■—■		📦	📦	📦	📦	€
52419	1000x600mm	10x10mm	28mm	Acoplamento quadrado	7.07	-	1	30	90,00€
52420	1500x600mm	10x10mm	28mm	Acoplamento quadrado	10.80	-	4	28	121,00€
52421	2000x600mm	10x10mm	28mm	Acoplamento quadrado	14.00	-	1	38	194,00€



GANCHO

REF.	mm				Compatível com					€
16354	100mm	10x10mm	28mm	28mm	Versões atuais dos carrinhos	0.04	10	100	-	1,50€
16355	200mm	10x10mm	28mm	28mm	Versões atuais dos carrinhos	0.06	10	100	-	2,00€
16356	100mm	10x10mm	28mm	28mm	Versões atuais dos carrinhos	0.78	10	100	-	2,50€
16357	200mm	10x10mm	28mm	28mm	Versões atuais dos carrinhos	0.10	10	100	-	2,80€
51655	31mm	12,5x12,5mm	32,5mm	45mm	Versões antigas dos carrinhos	0.07	10	100	4000	4,70€
51658	82mm	12,5x12,5mm	32,5mm	45mm	Versões antigas dos carrinhos	0.05	10	100	1500	5,10€
51422	95mm	12,5x12,5mm	32,5mm	45mm	Versões antigas dos carrinhos	0.05	-	100	1500	3,40€
51975	30mm	12,5x12,5mm	32,5mm	45mm	Versões antigas dos carrinhos	0.03	-	100	4000	2,45€
51419	90mm	12,5x12,5mm	32,5mm	45mm	Versões antigas dos carrinhos	0.03	-	100	2000	3,40€
51656	91mm	12,5x12,5mm	32,5mm	45mm	Versões antigas dos carrinhos	0.05	10	100	1500	4,20€
51654	95mm	12,5x12,5mm	32,5mm	45mm	Versões antigas dos carrinhos	0.09	10	100	4000	5,40€
52635	200mm	12,5x12,5mm	32,5mm	45mm	Versões antigas dos carrinhos	0.14	10	50	1500	5,30€
51657	400mm	12,5x12,5mm	32,5mm	45mm	Versões antigas dos carrinhos	0.30	10	50	1000	6,50€
51653	148mm	12,5x12,5mm	32,5mm	45mm	Versões antigas dos carrinhos	0.28	-	10	840	5,80€



16354



16355



16356



16357



51655



51658



51422



51975



51419



51656



51654



52635







51657



51653



PEÇAS DE REPOSIÇÃO

REF.	DESCRIÇÃO					€
15023	RODA FIXA PARA NO. 53765, 53766, 53870	0.65	-	10	-	12,50€
15025	RODA FIXA PARA NO. 53900, 53901	0.65	-	10	-	12,50€
15040	RODA FIXA PARA NO. 53904, 54006, 54389	0.66	-	10	-	12,50€
15024	VOLANTE PARA NO. 53765, 53766, 53870	0.95	-	8	-	15,00€
15026	VOLANTE PARA NO. 53900, 53901	0.95	-	8	-	15,00€
15041	RODA GIRATORIA PARA REF. 53904, 54006, 54389	0.98	-	8	-	15,00€
14580	TAMPA SUPERIOR PARA REF. 53661 - 53686 - 53904 - 54006 - 54389	2.60	-	3	39	45,00€
15034	TAMPA SUPERIOR PARA NO. 53868	2.00	-	2	-	72,00€
15038	TAMPA SUPERIOR PARA NO. 53869, 53870	2.00	-	2	-	36,00€
14783	PROTECTOR DIREITO PARA REF. 53686, 53661, 53904, 54006, 54389	0.25	-	50	-	5,50€
15058	PROTEÇÃO LATERAL PARA NO. 53868	0.36	-	-	-	7,70€
15065	PROTEÇÃO LATERAL PARA NO. 53869, 53870	0.28	-	12	-	6,50€
15030	ALÇA PARA NO. 53765, 53766	0.30	-	50	-	8,00€
15033	ALÇA ESTREITA PARA NO. 53868	0.14	-	50	-	6,00€
15035	ALÇA PARA NO. 53869	0.36	-	20	-	8,50€
15036	ALÇA PARA NO. 53870	0.36	-	20	-	8,50€
15037	ALÇA PARA NO. 53900, 53901	0.10	-	-	-	8,00€
15042	ALÇA PARA NO. 53904, 54006	0.10	-	1	-	7,50€
15050	ALÇA PARA NO. 53661, 53686	0.10	-	50	-	9,50€
16387	ALÇA PARA NO. 54389	0.75	-	20	108	10,50€
14578	CONJUNTO DE 2 GRANDES INSERTOS DE ROLAMENTO DE ROLAMENTOS DE ESFERA PARA 53661, 53686, 53904, 54006	1.05	-	25	-	14,90€



CADEADOS

REF.	mm						€
53403	38mm	Curto	0.15	8	96	3168	6,50€
53405	32mm	Curto	0.10	8	96	3168	5,70€
53406	50mm	Curto	0.30	8	48	1728	8,55€
53407	63mm	Curto	0.35	8	48	3168	13,60€
53408	75mm	Curto	0.76	3	24	840	21,00€
53409	50mm	Longo	0.30	8	48	3168	10,30€



CADEADOS RESISTENTES À ÁGUA

REF.	mm						€
53399	30mm		0.90	8	48	3168	3,80€
53400	40mm		0.20	8	48	499	6,20€
53401	50mm		0.35	8	48	499	8,00€
53402	65mm		0.05	10	40	960	10,30€



CILINDRO COM CHAVE PARA CARRINHOS

REF.	DESCRIÇÃO					€
16776	601	0.05	-	100	14080	12,00€
16777	602	0.05	-	100	14080	12,00€
16778	608	0.05	-	100	14080	12,00€
16779	604	0.05	-	100	14080	12,00€
16780	605	0.05	-	100	14080	12,00€



54388

40.50 - 1 10

CARRINHO PARA DIAGNÓSTICO

ESPECIFICAÇÕES TÉCNICAS			
Dimensões gerais	1050,7mm	513,4mm	397mm
Capacidade total	90Kg		
Medidas do bandeja superior	188,5mm	433mm	436mm
Medidas da bandeja central	249,5mm	433mm	402,5mm
Medidas da bandeja inferior	198mm	433mm	397mm
Medidas gaveta interior	275,5mm	433mm	397mm



366,00€



REPOSIÇÕES
DISPONÍVEIS

51576

125,00€

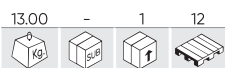

CARRO COM 3 BANDEJAS



ESPECIFICAÇÕES TÉCNICAS

Dimensões gerais	800mm	840mm	397mm
Capacidade total	100Kg		

52373

252,00€



CARRO COM 3 BANDEJAS MAXI



ESPECIFICAÇÕES TÉCNICAS

Dimensões gerais	800mm	1010mm	630mm
Capacidade total	150Kg		

54499

141,00€

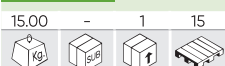

CARRINHO DE FERRAMENTAS 3 PRATELEIRAS 1 GAVETA



ESPECIFICAÇÕES TÉCNICAS

Dimensões gerais	750mm	830mm	350mm
Capacidade total	150Kg		

51738

850,00€

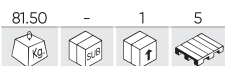

MESA DE TRABALHO COM 3 GAVETAS

ESPECIFICAÇÕES TÉCNICAS

Dimensões gerais	865mm	2000mm	640mm
Capacidade total	1T		
Medidas gaveta interior	142mm	348mm	441mm



REPOSIÇÕES DISPONÍVEIS

51737

699,00€

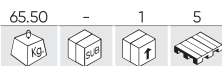

MESA DE TRABALHO COM 2 GAVETAS



REPOSIÇÕES DISPONÍVEIS



ESPECIFICAÇÕES TÉCNICAS

Dimensões gerais	865mm	1500mm	640mm
Capacidade total	800Kg		
Medidas gaveta interior	142mm	348mm	441mm

53674

447,00€

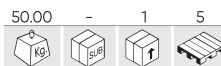

MESA DE TRABALHO COM 1 GAVETA



REPOSIÇÕES DISPONÍVEIS



ESPECIFICAÇÕES TÉCNICAS

Dimensões gerais	865mm	1100mm	640mm
Capacidade total	800Kg		
Medidas gaveta interior	142mm	348mm	441mm

51035

799,00€

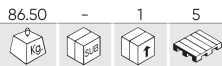

BANCADA DE TRABALHO COM 2 GAVETAS E PAINEL FRONTAL



ACOPLAMENTO QUADRADO

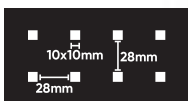

ESPECIFICAÇÕES TÉCNICAS

Dimensões gerais	1550mm	1500mm	640mm
Capacidade total	600Kg		
Medidas gaveta interior	142mm	348mm	441mm

54328

199,00€



BANCADA DE TRABALHO DOBRÁVEL COM PAINEL TRASEIRO



EXPOSITOR SEM FERRAMENTAS

ACOPLAMENTO QUADRADO

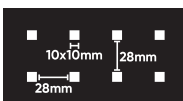

ESPECIFICAÇÕES TÉCNICAS

Dimensões gerais	1440mm	1200mm	640mm
Capacidade total	150Kg		
Dimensões fixado	1440mm	1200mm	122mm

51575

317,00€

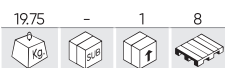

CAIXA DE FERRAMENTAS COM 6 GAVETAS



ESPECIFICAÇÕES TÉCNICAS

Dimensões gerais	377mm	660mm	307mm
Capacidade total	100Kg		

51600

109,00€



CAIXA DE FERRAMENTAS COM 3 GAVETAS FRONTAIS



ESPECIFICAÇÕES TÉCNICAS

Dimensões gerais	288mm	534mm	218mm
Capacidade total	65Kg		

CAIXA DE FERRAMENTAS

REF.	750mm	200mm	220mm	7.70	-	1	15	€
54393	750mm	200mm	220mm	7.70	-	1	15	99,00€
54394	530mm	200mm	220mm	5.70	-	1	22	70,00€
54395	450mm	200mm	220mm	6.20	-	1	24	58,00€
51574	405mm	205mm	205mm	3.39	-	1	31	58,00€



VER PÁGINA 22

DESCUBRA AS CAIXAS DE FERRAMENTAS QUE TEMOS DISPONÍVEIS PARA SI. VEJA A VISTA AMPLIADA DE CADA UMA DELAS NA SECÇÃO DE CAIXAS DE FERRAMENTAS E ESCOLHA A QUE MELHOR SE ADAPTA ÀS SUAS NECESSIDADES.



54518

457,50€

22.50 - 1 8



CARRINHO MODULAR COM 4 CAIXAS EMPILHÁVEIS

ESPECIFICAÇÕES TÉCNICAS

A Medidas primeiro módulo	115mm	555mm	340mm
Capacidade primeiro módulo		10Kg	
B Medidas segundo módulo	160mm	550mm	340mm
Capacidade segundo módulo		20Kg	
C Medidas terceiro módulo	410mm	580mm	340mm
Capacidade do terceiro módulo		40Kg	
D Medidas terceiro módulo	310mm	550mm	340mm
Capacidade do terceiro módulo		30Kg	



REF.	DESCRIÇÃO					€
A 54519	CAIXA DE FERRAMENTAS EMPILHÁVEL COM ORGANIZADOR DE PEÇAS (12 COMPARTIMENTOS)	3.60	-	1	32	72,00€
B 54520	CAIXA DE FERRAMENTAS EMPILHÁVEL COM 2 ORGANIZADORES LATERAIS DE PEÇAS (11 COMPARTIMENTOS)	4.00	-	1	24	72,00€
C 54535	CAIXA DE FERRAMENTAS EMPILHÁVEL COM RODAS (85L)	10.80	-	1	10	226,00€
D 54537	CAIXA DE FERRAMENTAS EMPILHÁVEL (40L)	4.90	-	1	12	102,00€



BOLSA PARA FERRAMENTAS

REF.	DESCRIÇÃO								€
53702	Pequena	300mm	305mm	190mm	1.00	-	10	150	33,50€
53703	Média	300mm	406mm	190mm	1.40	-	10	120	41,00€
53704	Grande	300mm	508mm	230mm	1.65	-	10	120	43,50€



53702



53703



53704

53782

14,00€

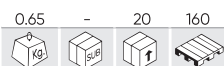

BOLSA PARA FERRAMENTAS ELÉTRICAS - GRANDE



Material	Tela Oxford/Oxford Cloth
Capacidade	36L
Peso	0,65Kg
Dimensões (CxLxA)	500x250x290mm



54080

54,00€



BOLSA DE FERRAMENTAS



Material	Tela Oxford/Oxford Cloth
Capacidade	20L
Peso	2,00Kg
Dimensões (CxLxA)	480x210x340mm

54374

77,00€



SACO DE FERRAMENTAS



Material	Tela Oxford/Oxford cloth 1680D/600D, PVC
Capacidade	41L
Peso	2,10Kg
Dimensões (CxLxA)	360x230x500mm

50957

22,00€

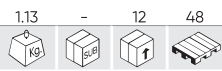

CAIXA 24+2 COMPARTIMENTOS



50959

14,00€

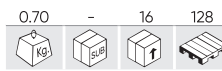

CAIXA 20+1 COMPARTIMENTOS



51050

285,00€

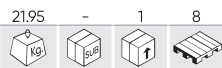

ESTANTERIA COM 47 COMPARTIMENTOS

COMPARTIMENTOS PEQUENOS

Total: 32
Medidas: 16x10x7,5 cm
Medidas da estanteria: 84x16x8 cm
Total estantes: 4

COMPARTIMENTOS GRANDES

Total: 15
Medidas: 24x14,5x13 cm
Medidas da estanteria: 84x14x24 cm
Total estantes: 3



51051

40,00€

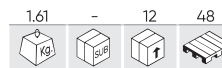

ORGANIZADOR DE 5 COMPARTIMENTOS



Caixas inseparáveis

53903

66,00€

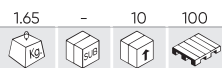

CONJUNTO DE 3 BANDEJAS DE FERRAMENTAS ELÁSTICAS ANTI DERRAPANTE

REF.	DESCRIÇÃO									€
15010	Pequena	137mm	285mm	27mm	0.40	-	20	360	17,90€	
15011	Média	202mm	285mm	27mm	0.45	-	20	320	19,40€	
15012	Grande	300mm	543mm	27mm	1.05	-	10	120	36,50€	



15012



15011



15010



54682 54,00€

1.70 - 10 40

kg sub f

PLATAFORMA MÓVEL DE AJOELHAMENTO



ESPECIFICAÇÕES TÉCNICAS

Dimensões gerais	85mm	500mm	255mm
Capacidade total	100Kg		



53192 53,00€

0.70 - 2 48

kg sub f

ESTRADO EM ESPUMA



ESPECIFICAÇÕES TÉCNICAS

Dimensões gerais	540mm	420mm	1200mm
Dimensões fexado	200mm	420mm	180mm

53191 14,80€

0.15 - 5 160

kg sub f

ESTRADO EM ESPUMA



ESPECIFICAÇÕES TÉCNICAS

Dimensões gerais	320mm	480mm	180mm
------------------	-------	-------	-------

50789 29,00€

0.89 10 20 500

kg sub f

BARRA MAGNÉTICA PARA FERRAMENTAS



RECIPIENTE MAGNÉTICO FLEXÍVEL

REF.									€
52516	ø225mm	ø88mm	135mm	43mm	0.42	6	24	1152	10,00€
52517	ø135mm	ø53mm	90mm	31mm	0.10	12	72	1152	6,00€

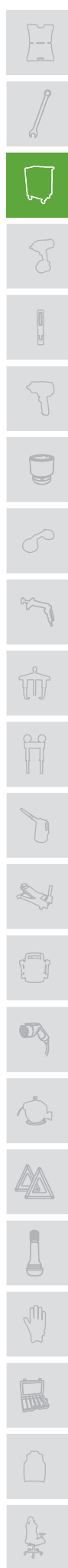

50787

8,00€

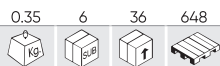

PRATO REDONDO MAGNÉTICO Ø150MM



50788

14,50€

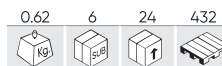

PRATO RECTÂNGULAR MAGNÉTICO



52466

11,00€

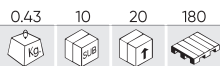

RECIPIENTE MAGNÉTICO

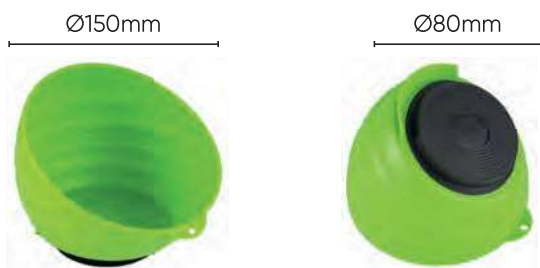

53958

6,50€

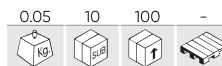

CONJUNTO DE 5 ÍMÃS



52148

65,00€

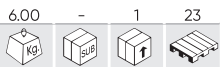

ESTRADO MECÂNICO PLÁSTICO

ESPECIFICAÇÕES TÉCNICAS

Dimensões gerais	120mm	1020mm	480mm
Capacidade total	150Kg		



50843

79,00€

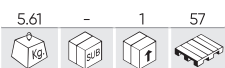

BANCO HIDRÁULICO



ESPECIFICAÇÕES TÉCNICAS

Dimensões gerais	390-520mm	380mm	380mm
Capacidade total	135Kg		

54583

89,00€

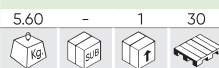

BANQUETA PNEUMÁTICA COM RODÍZIOS



ESPECIFICAÇÕES TÉCNICAS

Dimensões gerais	550mm	470mm	300mm
Capacidade total	136Kg		

50844

65,00€



BANCO DE AÇO



ESPECIFICAÇÕES TÉCNICAS

Dimensões gerais	380mm	360mm	375mm
Capacidade total	100Kg		

50808

77,00€

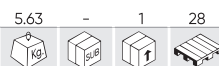

ESTRADO DE MECÂNICO ALMOFADADO DOBRÁVEL



ESPECIFICAÇÕES TÉCNICAS

Dimensões gerais	105mm	930mm	440mm
Capacidade total	150Kg		

53211

75,00€

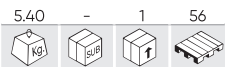

ESTRADO MECÂNICO ALMOFADADO DOBRÁVEL



ESPECIFICAÇÕES TÉCNICAS

Dimensões gerais	125mm	900mm	420mm
Capacidade total	150Kg		
Dimensões fechado	350mm	450mm	420mm
Capacidade fechado	120Kg		

52542

109,00€

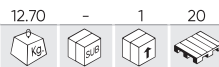

ESTRADO MECÂNICO ALMOFADADOS DOBRÁVEL



ESPECIFICAÇÕES TÉCNICAS

Dimensões gerais	105mm	1180mm	420mm
Capacidade total	135Kg		
Dimensões fechado	475mm	650mm	450mm
Capacidade fechado	115Kg		

52871 258,00€

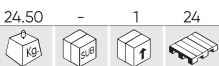

**TORNO DE BANCADA
ABERTURA RÁPIDA BASE
ROTATIVA**

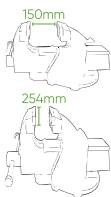

52869 55,00€

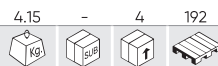

**TORNO DE BANCADA
100MM**

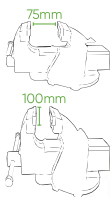

52870 100,00€

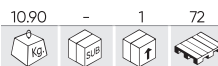

**TORNO DE BANCADA
150MM**

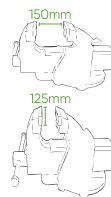

53031 64,00€

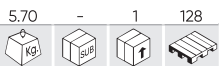

**TORNO DE BANCADA BASE
ROTATIVA 4"**

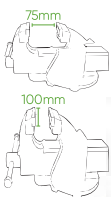

53032 126,00€

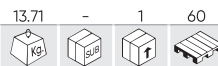

**TORNO DE BANCADA BASE
ROTATIVA 6"**

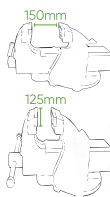

52308 440,00€

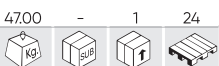

BIGORNA 50KG



52309 941,00€



BIGORNA PROFESSIONAL 100KG



ESPECIFICAÇÕES TÉCNICAS

Dimensões gerais	190mm	625mm	140mm
Capacidade total	50Kg		

ESPECIFICAÇÕES TÉCNICAS

Dimensões gerais	245mm	790mm	180mm
Capacidade total	100Kg		

FERRAMENTAS ELÉTRICAS SEM FIO

20V

APARAFUSAR

PERFURAR

LIXAR/POLIR

SERRAR

12V

APARAFUSAR

PERFURAR

LIXAR/POLIR

123 FERRAMENTAS ESPECIAIS 132

126 FERRAMENTAS DE JARDINAGEM 136

127 BATERIAS / CARREGADORES 138

129 ACESSÓRIOS / CONSUMÍVEIS 143

139 SERRAR 142

141 FERRAMENTAS ESPECIAIS 142

141 BATERIAS / CARREGADORES 142



ORGANIZE E PROTEJA AS SUAS FERRAMENTAS COM OS NOSSOS ESTOJOS

ESPECIALMENTE CONCEBIDOS PARA GUARDAR E PROTEGER AS SUAS FERRAMENTAS DE FORMA SEGURA E CONVENIENTE



✓ Máxima durabilidade

Os nossos estojos resistem ao desgaste da utilização quotidiana e protegem as suas ferramentas de golpes e quedas.

✓ Transporte fácil

O design ergonómico e compacto permite um transporte fácil para qualquer lugar.

✓ Resistente à água e ao pó

Protege as suas ferramentas de condições de trabalho ou de armazenamento extremas.

✓ Espaço personalizado

Cada estojo é concebido à medida para proteger as suas ferramentas, garantindo um ajuste perfeito e uma proteção ideal.



TODOS OS ESTOJOS INCLUEM BATERIA E CARREGADOR
TAMBÉM CONCEBIDOS PARA GUARDAR UMA BATERIA EXTRA!



20V APARAFUSAMENTO

60050C 564,00€



CHAVE DE IMPACTO SEM FIO 1" 2300NM COM ESTOJO



REPOSIÇÕES DISPONÍVEIS

CONTÉM

REF.						€
60050	A	3.60	-	4	80	409,00€
60015	B	1.00	-	5	630	138,00€
60016	C	0.80	-	5	210	49,00€

Medida do quadrado	1"
Tensão	20V
Potência	1300W
Torque de aperto	1800Nm
Torque de desaperto	2300Nm
Velocidade nominal	1150, 1450, 1850RPM
Impulsos IPM	1000, 1800, 2400
Velocidades	3
Compatível com	60012, 60013, 60015, 60016, 60017
Peso	3,60Kg
Dimensões (CxLxA)	240x80x220mm

60048C 560,00€



CHAVE DE IMPACTO SEM FIO 3/4" 1300NM COM ESTOJO



REPOSIÇÕES DISPONÍVEIS

CONTÉM

REF.						€
60048	A	3.26	-	4	80	366,00€
60015	B	1.00	-	5	630	138,00€
60016	C	0.80	-	5	210	49,00€

Medida do quadrado	3/4"
Tensão	20V
Potência	1000W
Torque de aperto	1000Nm
Torque de desaperto	1300Nm
Velocidade nominal	1100, 1400, 1800RPM
Impulsos IPM	1000, 1600, 2200
Velocidades	3
Compatível com	60012, 60013, 60015, 60016, 60017
Peso	3,20Kg
Dimensões (CxLxA)	220x85x230mm



PÁGINA 138

PILHAS E CARREGADORES NÃO INCLuíDOS NAS FERRAMENTAS INDIVIDUALES

Três tipos de bateria e dois tipos de carregador. Escolha o que você preferir!



20V APARAFUSAMENTO

60044C 485,00€



CHAVE DE IMPACTO SEM FIO 1/2" 1300NM COM ESTOJO



REPOSIÇÕES DISPONÍVEIS

CONTÉM

REF.						€
60044	A	3.25	-	5	72	330,00€
60013	B	0.75	-	5	700	80,00€
60016	C	0.80	-	5	210	49,00€

Medida do quadrado	1/2"
Tensão	20V
Potência	1000W
Torque de aperto	1200Nm
Torque de desaperto	1300Nm
Velocidade nominal	1000, 1350, 1600RPM
Impulsos IPM	1000, 1600, 2000
Velocidades	3
Compatível com	60012, 60013, 60015, 60016, 60017
Peso	3,20Kg
Dimensões (CxLxA)	214x90x217mm

60051C 372,50€



CHAVE DE IMPACTO SEM ESCOVAS A BATERIA 1/2" 1000NM COM ESTOJO



REPOSIÇÕES DISPONÍVEIS

CONTÉM

REF.						€
60051	A	2.20	-	4	150	211,00€
60013	B	0.75	-	5	700	80,00€
60016	C	0.80	-	5	210	49,00€

Medida do quadrado	1/2"
Tensão	20V
Potência	850W
Torque de aperto	850Nm
Torque de desaperto	1000Nm
Velocidade nominal	1400, 1900, 2400RPM
Impulsos IPM	1800, 2200, 2800
Velocidades	3
Compatível com	60012, 60013, 60015, 60016, 60017
Peso	2,20Kg
Dimensões (CxLxA)	97x80x220mm



PÁGINA 138

PILHAS E CARREGADORES NÃO INCLUÍDOS NAS FERRAMENTAS INDIVIDUAIS

Três tipos de bateria e dois tipos de carregador. Escolha o que você preferir!



20V APARAFUSAMENTO

60046C 339,00€

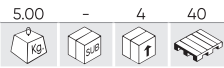

CHAVE DE IMPACTO SEM FIO 1/2" 800NM COM ESTOJO



REPOSIÇÕES DISPONÍVEIS

CONTÉM

REF.						€
60046	A	1.50	-	4	224	174,00€
60013	B	0.75	-	5	700	80,00€
60016	C	0.80	-	5	210	49,00€

Medida do quadrado	1/2"
Tensão	20V
Potência	700W
Torque de aperto	550Nm
Torque de desaperto	800Nm
Velocidade nominal	1800, 2300, 2800RPM
Impulsos IPM	1800, 2200, 3000
Velocidades	3
Compatível com	60012, 60013, 60015, 60016, 60017
Peso	1,50Kg
Dimensões (CxLxA)	80x90x210mm

60052C 287,00€

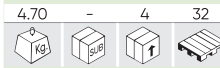

FURADEIRA DE IMPACTO SEM FIO SEM ESCOVA DE 1/4" 230NM COM ESTOJO DE ARMAZENAMENTO



REPOSIÇÕES DISPONÍVEIS

CONTÉM

REF.						€
60052	A	1.30	-	5	-	139,00€
60013	B	0.75	-	5	700	80,00€
60016	C	0.80	-	5	210	49,00€

Tamanho do eixo	1/4"
Tensão	20V
Potência	500W
Torque de aperto	230Nm
Velocidade nominal	1200, 1900, 2500, 3200RPM
Impulsos IPM	1400, 2200, 3000, 4000
Velocidades	4
Compatível com	60012, 60013, 60015, 60016, 60017
Peso	0,80Kg
Dimensões (CxLxA)	110x70x205mm



PÁGINA 149

60052

DESCUBRA TODOS OS ACESSÓRIOS DISPONÍVEIS PARA AS NOSSAS FERRAMENTAS ELÉTRICAS SEM FIOS

Encontre todos os acessórios que tornarão o seu trabalho mais fácil, mais confortável e mais seguro



20V PERFURAÇÃO

60047C 318,00€

5,25 - 4 40

FURADEIRA PERCUTORA SEM FIO DE 2 VELOCIDADES COM CAIXA



REPOSIÇÕES DISPONÍVEIS

CONTÉM

REF.						€
60047	A	1.00	10	4	90	237,50€
60013	B	0.75	-	5	700	80,00€
60016	C	0.80	-	5	210	49,00€

Tensão	20V
Potência	900W
Binário máximo	150Nm
Velocidade nominal	500, 2200RPM
Taxa de impacto	35000BPM
amanho do mandril	Ø13mm
Velocidades	2
Compatível com	60012, 60013, 60015, 60016, 60017
Peso	1,6Kg
Dimensões (CxLxA)	420x105x340mm

60053C 549,00€

900 - 4 16

KIT DE REBARBADORA ANGULAR E MARTELO PERFORADOR A BATERIA COM MALA DE TRANSPORTE



CONTÉM

REF.						€
60047	A	1.00	10	4	90	237,50€
60049	B	1.78	10	4	156	175,00€
60013	C	0.75	-	5	700	80,00€
60016	D	0.80	-	5	210	49,00€

60049

Tensão	20V
Potência	1115W
Velocidade nominal	8000RPM

60047

Tensão	20V
Potência	900W
Velocidade nominal	500, 2200RPM



PÁGINA 144

✓ **60047**

DESCUBRA TODOS OS ACESSÓRIOS DISPONÍVEIS PARA AS NOSSAS FERRAMENTAS ELÉTRICAS SEM FIOS

Encontre todos os acessórios que tornarão o seu trabalho mais fácil, mais confortável e mais seguro



20V LIXAMENTO/POLIMENTO

60054C 329,00€

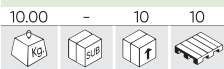

REBARBADORA ÂNGULAR BRUSHLESS 115MM COM CAIXA



REPOSIÇÕES DISPONÍVEIS

CONTÉM

REF.						€
60054	A	1.78	-	4	120	171,00€
60013	B	0.75	-	5	700	80,00€
60016	C	0.80	-	5	210	49,00€

Tensão	20V
Potência	1115W
Velocidade nominal	8000RPM
Diâmetro do disco	115mm
Diâmetro do eixo	M14
Vibrações por minuto	0,8m/s2
Compatível com	60012, 60013, 60015, 60016, 60017
Peso	1,78Kg
Dimensões (CxLxA)	318x137x105mm

60049C 329,00€



REBARBADORA ÂNGULAR BRUSHLESS 125MM COM CAIXA



REPOSIÇÕES DISPONÍVEIS

CONTÉM

REF.						€
60049	A	1.78	10	4	156	175,00€
60013	B	0.75	-	5	700	80,00€
60016	C	0.80	-	5	210	49,00€

Tensão	20V
Potência	1115W
Velocidade nominal	8000RPM
Diâmetro do disco	125mm
Diâmetro do eixo	M14
Vibrações por minuto	0,8m/s2
Compatível com	60012, 60013, 60015, 60016, 60017
Peso	1,78Kg
Dimensões (CxLxA)	318x137x105,5mm



PÁGINA 146

✓ 60049 - 60054

DESCUBRA TODOS OS ACESSÓRIOS DISPONÍVEIS PARA AS NOSSAS FERRAMENTAS ELÉTRICAS SEM FIOS

Encontre todos os acessórios que tornarão o seu trabalho mais fácil, mais confortável e mais seguro



20V LIXAMENTO/POLIMENTO

60023C 349,00€



MARTELO PERCUTOR BRUSHLESS COM MALETA



REPOSIÇÕES DISPONÍVEIS

CONTÉM

REF.						€
60023	A	3.10	-	5	120	212,00€
60013	B	0.75	-	5	700	80,00€
60016	C	0.80	-	5	210	49,00€

Tensão	20V
Potência	500W
Velocidade nominal	1350RPM
Taxa de impacto	4750BPM
Força de impacto	2,2J
Ø de perfuração em concreto	22mm
Ø de perfuração em aço	13mm
Ø de perfuração em madeira	28mm
amanho do mandril	Ø15mm
Velocidades	4
Compatível com	60012, 60013, 60015, 60016, 60017
Peso	1,8Kg
Dimensões (CxLxA)	286x75x218mm

60009C 335,00€



POLIDOR COM MOTOR BRUSHLESS COM CAIXA



REPOSIÇÕES DISPONÍVEIS

CONTÉM

REF.						€
60009	A	2.65	-	4	70	183,00€
60013	B	0.75	-	5	700	80,00€
60016	C	0.80	-	5	210	49,00€

Tensão	20V
Diâmetro do disco	180mm (7")
Velocidade nominal	800-2400RPM
Diâmetro do disco	180mm
Diâmetro do eixo	M14
Vibrações por minuto	89m/s2
Compatível com	60012, 60013, 60015, 60016, 60017
Peso	2,65Kg
Dimensões (CxLxA)	500x220x225mm



PÁGINA 143

✓ **60023**

DESCUBRA TODOS OS ACESSÓRIOS DISPONÍVEIS PARA AS NOSSAS FERRAMENTAS ELÉTRICAS SEM FIOS

Encontre todos os acessórios que tornarão o seu trabalho mais fácil, mais confortável e mais seguro



20V LIXAMENTO/POLIMENTO

60033

104,00€



LIXADORA BRUSHLESS



REPOSIÇÕES DISPONÍVEIS

Tensão	20V
Velocidade nominal	10000RPM
Diâmetro do disco	150mm
Compatível com	60012, 60013, 60015, 60016, 60017
Peso	1,00Kg
Dimensões (CxLxA)	210x150x150mm

20V SERRAGEM

60019

178,00€



SERRA SABRE COM MOTOR BRUSHLESS



REPOSIÇÕES DISPONÍVEIS

Tensão	20V
Velocidade nominal	3000RPM
Capacidade máxima de corte	10-150mm
Comprimento da serra	28mm
Compatível com	60012, 60013, 60015, 60016, 60017
Peso	3,45Kg
Dimensões (CxLxA)	440x160x160mm

60020

175,00€



PLAINA BRUSHLESS



REPOSIÇÕES DISPONÍVEIS

Tensão	20V
Velocidade nominal	16000RPM
Largura de corte	82mm
Profundidade de corte ajustável	0-2mm
Profundidade de rebaixo ajustável	0-10,5mm
Compatível com	60012, 60013, 60015, 60016, 60017
Peso	3,15Kg
Dimensões (CxLxA)	285x150x180mm

60011

175,00€



SERRA CIRCULAR COM MOTOR BRUSHLESS



REPOSIÇÕES DISPONÍVEIS

Tensão	20V
Velocidade nominal	4000RPM
Diâmetro do disco	115mm
Profundidade máxima de corte	42,80mm, 0°/28mm, 45°
Compatível com	60012, 60013, 60015, 60016, 60017
Peso	2,00Kg
Dimensões (CxLxA)	390x75x120mm



PÁGINA 147

✓ 60011 - 60019 - 60022

DESCUBRA TODOS OS ACESSÓRIOS DISPONÍVEIS PARA AS NOSSAS FERRAMENTAS ELÉTRICAS SEM FIOS

Encontre todos os acessórios que tornarão o seu trabalho mais fácil, mais confortável e mais seguro



20V SERRAGEM

60007C 329,00€



SERRA CIRCULAR COM MOTOR BRUSHLESS COM CAIXA



REPOSIÇÕES DISPONÍVEIS

CONTÉM

REF.						€
60007	A	3.75	-	5	60	170,00€
60013	B	0.75	-	5	700	80,00€
60016	C	0.80	-	5	210	49,00€

Tensão	20V
Velocidade nominal	4000RPM
Diâmetro do disco	165mm
Profundidade máxima de corte	55mm, 90° / 35mm, 45°
Compatível com	60012, 60013, 60015, 60016, 60017
Peso	3,10Kg
Dimensões (CxLxA)	270x170x290mm

60010C 299,00€



SERRA TICO-TICO BRUSHLESS COM CAIXA



REPOSIÇÕES DISPONÍVEIS

CONTÉM

REF.						€
60010	A	2.80	-	4	144	170,00€
60013	B	0.75	-	5	700	80,00€
60016	C	0.80	-	5	210	49,00€

Tensão	20V
Velocidade sem carga	2600SPM
Capacidade máxima de corte	8-135mm
Comprimento da serra	26mm
Compatível com	60012, 60013, 60015, 60016, 60017
Peso	2,80Kg
Dimensões (CxLxA)	230x80x210mm



PÁGINA 147

✓ 60007 - 60010

DESCUBRA TODOS OS ACESSÓRIOS DISPONÍVEIS PARA AS NOSSAS FERRAMENTAS ELÉTRICAS SEM FIOS

Encontre todos os acessórios que tornarão o seu trabalho mais fácil, mais confortável e mais seguro



20V SERRAGEM

60022

470,00€

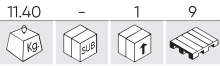

SERRA DE ESQUADRIA MOTOR BRUSHLESS



REPOSIÇÕES DISPONÍVEIS

Tensão	20V
Velocidade nominal	3500RPM
Diâmetro do disco	185mm
Profundidade máxima de corte	152-205mm/38-50mm, 45-90°
Compatível com	60012, 60013, 60015, 60016, 60017
Peso	8,60Kg
Dimensões (CxLxA)	580x490x320mm



20V FERRAMENTAS ESPECIAIS

60037C

348,00€



GRAMPEADOR ELÉTRICO COM CAIXA



REPOSIÇÕES DISPONÍVEIS

CONTÉM

REF.						€
60037	A	3.60	-	4	128	222,00€
60013	B	0.75	-	5	700	80,00€
60016	C	0.80	-	5	210	49,00€

Tensão	20V
Capacidade	100 Clavos/Nails
Compatível com	60012, 60013, 60015, 60016, 60017
Peso	3,60Kg
Dimensões (CxLxA)	292x94x259mm



PÁGINA 146-147

✓ 60037

DESCUBRA TODOS OS ACESSÓRIOS DISPONÍVEIS PARA AS NOSSAS FERRAMENTAS ELÉTRICAS SEM FIOS

Encontre todos os acessórios que tornarão o seu trabalho mais fácil, mais confortável e mais seguro



20V FERRAMENTAS ESPECIAIS

60032C 266,00€



PISTOLA PARA SILICONE A BATERIA COM CAIXA



REPOSIÇÕES DISPONÍVEIS

CONTÉM

REF.						€
60032	A	1.95	-	4	80	123,00€
60013	B	0.75	-	5	700	80,00€
60016	C	0.80	-	5	210	49,00€

Tensão	20V
Força máxima de empurrão	2500N
Velocidade de avanço	0,5-8 mm/s (30-480mm/min)
Capacidade do cartucho	300ml
Velocidade	Ajustable/Adjustable
Compatível com	60012, 60013, 60015, 60016, 60017
Peso	1,60Kg
Dimensões (CxLxA)	420x70x270mm

60038C 411,00€



PISTOLA DE GRAXA PNEUMÉTICA ELÉTRICA COM MALETA



REPOSIÇÕES DISPONÍVEIS

CONTÉM

REF.						€
60038	A	3.90	-	4	56	255,00€
60013	B	0.75	-	5	700	80,00€
60016	C	0.80	-	5	210	49,00€

Tensão	20V
Pressão máxima	620BAR
Volume/vazão	200g/min
Capacidade do cartucho	420g
Capacidade de graxa a granel	600g
Capacidade de graxa a granel	NLGI#2
Comprimento	760mm
Modos de carregamento	Granel/Bulk, Cartucho/Cartridge, Sucção/Suction
Compatível com	60012, 60013, 60015, 60016, 60017
Peso	3,60Kg
Dimensões (CxLxA)	400x90x270mm



PÁGINA 138

PILHAS E CARREGADORES NÃO INCLUÍDOS NAS FERRAMENTAS INDIVIDUAIS

Três tipos de bateria e dois tipos de carregador. Escolha o que você preferir!



20V FERRAMENTAS ESPECIAIS

60003C 250,00€

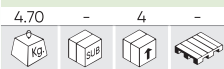

BOMBA DE COMPRESSOR DE AR ELÉTRICO COM CAIXA



REPOSIÇÕES DISPONÍVEIS

CONTÉM

REF.						€
60003	A	1.85	-	4	100	121,00€
60013	B	0.75	-	5	700	80,00€
60016	C	0.80	-	5	210	49,00€

Tensão	12-20V
Fluxo de ar	12-380L/min
Pressão de ar máxima	160PSI/11BAR/1100KPA
Comprimento da mangueira de alta pressão	760mm
Comprimento da mangueira de alta capacidade	460mm
Compatível com	60012, 60013, 60015, 60016, 60017
Peso	1,52Kg
Dimensões (CxLxA)	240x210x130mm

60043C 252,00€

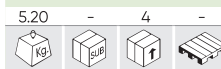

PISTOLA DE PINTURA SEM FIO COM CAIXA



REPOSIÇÕES DISPONÍVEIS

CONTÉM

REF.						€
60043	A	1.70	-	3	90	123,00€
60013	B	0.75	-	5	700	80,00€
60016	C	0.80	-	5	210	49,00€

Tensão	20V
Potência	280W
Capacidade do tanque	900ml
Diâmetro do bocal	2,5mm
Distância de pulverização	200mm
Capacidade de pulverização	700ml/min
Compatível com	60012, 60013, 60015, 60016, 60017
Peso	1,70Kg
Dimensões (CxLxA)	350x120x300mm



PÁGINA 138

PILHAS E CARREGADORES NÃO INCLuíDOS NAS FERRAMENTAS INDIVIDUALES

Três tipos de bateria e dois tipos de carregador. Escolha o que você preferir!



20V FERRAMENTAS ESPECIAIS

60041

77,00€



MULTIFERRAMENTA



REPOSIÇÕES DISPONÍVEIS

Tensão	20V
Velocidade nominal	5000, 19000RPM
Velocidades	6
Angulo de oscilação	4,2°
Compatível com	60012, 60013, 60015, 60016, 60017
Peso	1,30Kg
Dimensões (CxLxA)	290x75x85mm



60001

88,00€



ASPIRADOR PORTÁTIL SEM FIO



REPOSIÇÕES DISPONÍVEIS

Tensão	20V
Potência	3,8KPA
Capacidade do tanque	500ml
Compatível com	60012, 60013, 60015, 60016, 60017
Peso	0,87Kg
Dimensões (CxLxA)	410x100x140mm

60042

106,00€



PISTOLA DE AR QUENTE A BATERIA



REPOSIÇÕES DISPONÍVEIS

Tensão	20V
Potência	80W
Temperatura de saída	550°C
Diâmetro do bocal	34mm
Fluxo de ar	200L/min
Compatível com	60012, 60013, 60015, 60016, 60017
Peso	1,00Kg
Dimensões (CxLxA)	205x65x164mm



PÁGINA 148

60041

DESCUBRA TODOS OS ACESSÓRIOS DISPONÍVEIS PARA AS NOSSAS FERRAMENTAS ELÉTRICAS SEM FIOS

Encontre todos os acessórios que tornarão o seu trabalho mais fácil, mais confortável e mais seguro



20V FERRAMENTAS ESPECIAIS

60004

79,00€

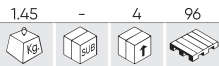

FOCO DE ILUMINAÇÃO LED FĂRĂ FIR



REPOSIÇÕES DISPONÍVEIS

Tensão	20V
Potência	1200-2400Lm
Modos de iluminação	2
Compatível com	60012, 60013, 60015, 60016, 60017
Peso	1,35Kg
Dimensões (CxLxA)	215x175x200mm

60035

30,00€

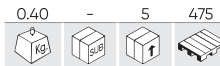

LĂMPADA DE TRABALHO PORTĂTIL LED



REPOSIÇÕES DISPONÍVEIS

Tensão	20V
Potência	500-1000Lm
Modos de iluminação	3
Compatível com	60012, 60013, 60015, 60016, 60017
Peso	0,26Kg
Dimensões (CxLxA)	70x80x185mm

60039

265,00€

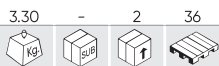

LAVADORA DE ALTA PRESSĂO A BATERIA BRUSHLESS



VÍDEO TUTORIAL



REPOSIÇÕES DISPONÍVEIS

Tensão	20V
Precisão	355PSI
Taxa de fluxo máxima	2,4L/min
Taxa de fluxo mínima	2,0L/min
Compatível com	60012, 60013, 60015, 60016, 60017
Peso	2,00Kg
Dimensões (CxLxA)	430x75x220mm

60027

99,00€



PULVERIZADOR ELÉTRICO INDUSTRIAL DE MOCHILA COM TANQUE DE 15L



Tensão	20V
Capacidade do depósito	15L
Pressão do trabalho	0,3-0,45Mpa
Distância de pulverização	1-1,2m
Compatível com	60012, 60013, 60016, 60017
Peso	3,30Kg
Dimensões (CxLxA)	350x170x660mm



PĂGINA 149

✓ 60004

DESCUBRA TODOS OS ACESSÓRIOS DISPONÍVEIS PARA AS NOSSAS FERRAMENTAS ELÉTRICAS SEM FIOS

Encontre todos os acessórios que tornarĂo o seu trabalho mais fĂcil, mais confortĂvel e mais seguro



20V

FERRAMENTAS ELÉTRICAS DE JARDINAGEM

60029

240,00€

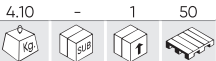

SERRA ELÉTRICA COM MOTOR BRUSHLESS



REPOSIÇÕES DISPONÍVEIS

Tensão	20V
Potência	720W
Velocidade de cadeia	7,8m/s
Comprimento da lâmina	254mm
Comprimento de corte	220mm
Passo da corrente	9,5mm (3/8")
Compatível com	60012, 60013, 60015, 60016, 60017
Peso	3,20Kg
Dimensões (CxLxA)	600x225x245mm

60030

112,00€



SOPRADOR DE FOLHAS



REPOSIÇÕES DISPONÍVEIS

Tensão	20V
Potência	280W
Compatível com	60012, 60013, 60015, 60016, 60017
Taxa de fluxo de ar	312m3/h, 520m3/h
Potência sonora (Lw)	90dB
Velocidade sem carga	15.000RPM
Peso	2,55Kg
Dimensões (CxLxA)	407x205x285mm

60031

142,00€

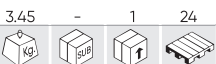

ELETROSERRA TELESCÓPICA



REPOSIÇÕES DISPONÍVEIS

Tensão	20V
Potência	230W
Velocidade sem carga	1450RPM
Comprimento da serra	457mm
Capacidade de corte	18mm
Compatível com	60012, 60013, 60015, 60016, 60017
Peso	3,34Kg
Dimensões (CxLxA)	920x215x192mm

60040

440,00€



MÁQUINA DE JARDIM MULTIFUNCCIONAL BATERIA (4 EM 1)



REPOSIÇÕES DISPONÍVEIS

Tensão	20V
Motosserra telescópica	4500RPM
Cortador de sebes	1200RPM
Cabeça de rosca	7000RPM
Disco de corte	7000RPM
Comprimento máximo	2,25m
Compatível com	60012, 60013, 60015, 60016, 60017
Peso	10,30Kg



PÁGINA 138

PILHAS E CARREGADORES NÃO INCLUIDOS NAS FERRAMENTAS INDIVIDUALES

Três tipos de bateria e dois tipos de carregador. Escolha o que você preferir!



20V FERRAMENTAS ELÉTRICAS DE JARDINAGEM

54252



VARREDORA DE IMPULSO MANUAL

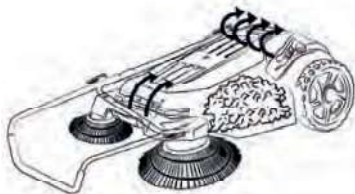

Capacidade	20L
Velocidade máxima de varredura	180m ² /h
Diâmetro da escova de disco	260mm
Tamanho da escova cilíndrica	108x350mm
Peso	10,80Kg
Dimensões (CxLxA)	1200x650x980mm
Dimensões dobradas	625x548x290mm

199,00€



VÍDEO TUTORIAL



REPOSIÇÕES DISPONÍVEIS

O CABO DESTA VASSOURA É AJUSTÁVEL E DOBRÁVEL: Permite ajustar tanto o ângulo quanto a altura em dois níveis, proporcionando um ajuste ideal para um uso mais confortável. Além disso, o cabo dobrável facilita o armazenamento.

60045

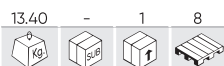

CORTA-RELVA SEM FIO

298,00€



REPOSIÇÕES DISPONÍVEIS



Tensão	40V
Potência	800W
Capacidade	35L
Altura de corte	25-75mm
Diâmetro de corte	370mm
Compatível com	60012, 60013, 60015, 60016, 60017
Peso	11,60Kg
Dimensões (CxLxA)	680x450x320mm

52598

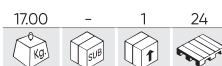

ROBÔ CORTA-RELVA

1.080,00€



CONEXÃO DE APP



REPOSIÇÕES DISPONÍVEIS

Tensão	240V
Potência	115,44W
Bateria	5200mAh
Altura de corte	25-55mm
Diâmetro de corte	180mm
Movimento	22m/min
Peso	7,50Kg
Dimensões (CxLxA)	500x355x240mm



PÁGINA 138

PILHAS E CARREGADORES NÃO INCLuíDOS NAS FERRAMENTAS INDIVIDUALES

Três tipos de bateria e dois tipos de carregador. Escolha o que você preferir!



BATERIAS E CARAGDORES

20V

USE-OS COM BATERIAS JBM: UMA ÚNICA BATERIA ADEQUADA PARA TODAS AS FERRAMENTAS

Três tipos de bateria e dois tipos de carregador. Escolha o que você preferir!

**Pilhas e carregadores NÃO INCLUIDOS nas ferramentas.*



BATERIA DE LITIO

REF.	DESCRIÇÃO	V	Ah					€
60012	BATERIA DE LITIO	20V	2.0Ah	0.45	-	5	920	48,00€
60013	BATERIA DE LITIO	20V	4.0Ah	0.75	-	5	700	80,00€
60015	BATERIA DE LITIO	20V	6.0Ah	1.00	-	5	630	138,00€



60012



60013



60015

CARREGADOR

REF.	DESCRIÇÃO	V	Ah					€
60016	CARREGADOR	20V	4A	0.80	-	5	210	49,00€
60017	CARREGADOR	20V	6A	0.80	-	5	290	64,00€



60016



60017
RÁPIDO



PÁGINA 143

DESCUBRA TODOS OS ACESSÓRIOS DISPONÍVEIS PARA AS NOSSAS FERRAMENTAS ELÉTRICAS SEM FIOS

Encontre todos os acessórios que tornarão o seu trabalho mais fácil, mais confortável e mais seguro



3,6V APARAFUSAMENTO

54769

200,00€

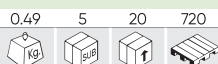

ROQUETE SEM FIOS DE 1/4" - 3,6V COM CARREGADOR



Medida do quadrado	1/4"
Tensão	3,6V
Potência	7,2W
Binário máximo do motor	3Nm
Torque manual máximo	62,3Nm
Velocidade nominal	320RPM
LED	Si/Yes
Carregador	USB Tipo C/ USB Type C
Tipo de pilha	Lithium-ION/Litio-ION 3,6V, 2,0Ah
Dimensões (CxLxA)	35x215x35mm

54683

58,00€



CONJUNTO DE CHAVES DE FENDAS E BROCAS SEM FIOS



REPOSIÇÕES DISPONÍVEIS



VÍDEO TUTORIAL

Medida do quadrado	1/4"
Tensão	3,6V
Torque de aperto	6Nm
Velocidade nominal	210RPM
Bateria	LI-ION 1300mAh
Peso	1,00Kg
Dimensões (CxLxA)	180x45x145mm

12V APARAFUSAMENTO

60062C

216,00€



ROQUETE ELÉCTRICO DE 1/2" BRUSHLESS COM CAIXA



REPOSIÇÕES DISPONÍVEIS

CONTÉM

REF.						€
60062	A	1.90	-	5	150	169,00€
60025	B	0.30	5	4	700	34,00€
60026	C	0.20	5	40	1400	40,50€

Medida do quadrado	1/2"
Tensão	12V
Potência	360W
Torque de aperto	60Nm
Torque de desaperto	60Nm
Velocidade nominal	175RPM
Inclui	60062, 60025, 60026
Compatível com	60025, 60026
Peso	1,17Kg
Dimensões (CxLxA)	69x50x310,3mm



PÁGINA 142

PILHAS E CARREGADORES NÃO INCLUÍDOS NAS FERRAMENTAS INDIVIDUALES

Três tipos de bateria e dois tipos de carregador. Escolha o que você preferir!



12V APARAFUSAMENTO

60059C 167,00€



BERBEQUIM DE IMPACTO SEM ESCOVAS 3/8" 250 NM COM CAIXA



CONTÉM

REF.						€
60059	A	0.95	-	5	36	99,00€
60025	B	0.30	5	4	700	34,00€
60026	C	0.20	5	40	1400	40,50€

Medida do quadrado	3/8"
Tensão	12V
Potência	435W
Torque de desaperto	250Nm
Velocidade nominal	1200, 1800, 2700RPM
Impulsos IPM	1100, 2100, 3200
Velocidades	3
Compatível com	60025, 60026
Peso	0,95Kg
Dimensões (CxLxA)	126x69x184mm

60060C 165,00€



BERBEQUIM DE IMPACTO SEM ESCOVAS 1/4" 150 NM COM CAIXA



CONTÉM

REF.						€
60060	A	0.95	-	5	36	99,00€
60025	B	0.30	5	4	700	34,00€
60026	C	0.20	5	40	1400	40,50€

Medida do quadrado	1/4"
Tensão	12V
Potência	396W
Torque de desaperto	150Nm
Velocidade nominal	1200, 1800, 2700RPM
Impulsos IPM	1100, 2100, 3200
Velocidades	3
Compatível com	60025, 60026
Peso	0,95Kg
Dimensões (CxLxA)	126x69x184mm



PÁGINA 142

PILHAS E CARREGADORES NÃO INCLUÍDOS NAS FERRAMENTAS INDIVIDUAIS

Três tipos de bateria e dois tipos de carregador. Escolha o que você preferir!



12V PERFURAÇÃO

60058C 154,00€



MARTELO PERFURADOR SEM ESCOVAS 12V COM CAIXA



CONTÉM

REF.						€
60058	A	0.88	-	5	70	91,00€
60025	B	0.30	5	4	700	34,00€
60026	C	0.20	5	40	1400	40,50€

Tensão	12V
Potência	350W
Binário máximo	45Nm
Velocidade nominal	1700RPM
Taxa de impacto	6750, 25500BPM
Ø de perfuração em concreto	8mm
Ø de perfuração em aço	10mm
Ø de perfuração em madeira	25mm
Velocidades	2
amanho do mandril	Ø10mm
Inclui	60058, 60025, 60026
Compatível com	60025, 60026
Peso	0,88Kg
Dimensões (CxLxA)	168x185x56mm

12V LIXAMENTO/POLIMENTO

60061C 149,00€



FERRAMENTA DE CORTE SEM FIOS DE 12V COM CAIXA



REPOSIÇÕES DISPONÍVEIS

CONTÉM

REF.						€
60061	A	0.56	-	5	45	77,00€
60025	B	0.30	5	4	700	34,00€
60026	C	0.20	5	40	1400	40,50€

Tensão	12V
Potência	165W
Velocidade nominal	18500RPM
Diâmetro do disco	76mm
Diâmetro do eixo	M5
Vibrações por minuto	18.500/min
Compatível com	60025, 60026
Peso	0,56Kg
Dimensões (CxLxA)	163x113x89mm



PÁGINA 148

✓ **60061**

DESCUBRA TODOS OS ACESSÓRIOS DISPONÍVEIS PARA AS NOSSAS FERRAMENTAS ELÉTRICAS SEM FIOS

Encontre todos os acessórios que tornarão o seu trabalho mais fácil, mais confortável e mais seguro



12V SERRAGEM

60056 142,00€



MINI SERRA DE 12V



Tensão	12V
Potência	230W
Velocidade nominal	9m/s
Capacidade máxima de corte	100mm
Diâmetro do disco	1/4"
Comprimento da serra	160mm
Compatível com	60025, 60026
Peso	1,10Kg
Dimensões (CxLxA)	135x100x390mm

12V FERRAMENTAS ESPECIAIS

60055 78,00€



RÁDIO SEM FIOS



Tensão	12V
Potência	10W
Compatível com	60025, 60026
Conectividade Bluetooth	15m
Peso	1,10Kg
Dimensões (CxLxA)	197x138x106mm

BATERIAS E CARAGDORES



REF.	DESCRIÇÃO	V	Ah	Kg					€
60025	CARREGADOR	12V	2A	0.30Kg	0.30	5	4	700	34,00€
60026	BATERIA DE LITIO	12V	2.0Ah	0.20Kg	0.20	5	40	1400	40,50€



60025



60026

**PEÇAS SOBRESSELENTES E ACESSÓRIOS
PARA ENFRENTAR QUALQUER DESAFIO**

Esteja perfeitamente equipado para cada trabalho. Oferecemos-lhe toda uma gama de acessórios complementares para as nossas ferramentas.



PEÇAS DE REPOSIÇÃO



PARA REF. 60023

53850

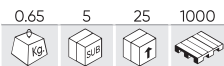

CONJUNTO DE BROCAS PARA BERBEQUIM PERCUTOR

Ø 5x110, 6x110, 6x160, 8x110, 8x160, 10x160, 12x160mm



15,90€



REPOSIÇÕES DISPONÍVEIS

FORMÃO SDS-PLUS

REF.	mm					€
14837	14x250mm	0.25	10	100	-	3,30€
14838	20x250mm	0.25	10	100	-	3,40€
14839	40x250mm	0.29	10	50	-	4,70€
14840	250mm	0.27	10	50	-	3,35€



14837 14838 14839 14840

14841

2,58€

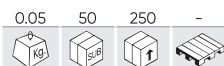

ADAPTADOR SDS-PLUS PARA CARTUCHO DE PERFURAÇÃO DE 1/2 "



Medidas	1/2"-75mm
Diâmetro	10mm
Material	Acero/Steel

14842

9,50€



PORTA-BROCAS DE MUDANÇA RÁPIDA 2-13 MM 1/2 "-20 UNF (ROSCA FINA UNIFICADA)



Medidas	1/2"-60mm
Diâmetro	4mm
Material	Acero/Steel

PARA REF. 60047



53860

3,90€

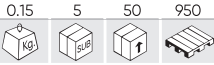

CONJUNTO DE 5 BROCAS PARA ALVENARIA 4-10 MM



REPOSIÇÕES DISPONÍVEIS



ø 4x75, 5x80, 6x100, 8x120, 10x120mm



53861

5,80€

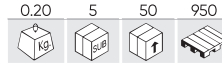

CONJUNTO DE 8 BROCAS PARA ALVENARIA 3-10MM



REPOSIÇÕES DISPONÍVEIS



ø 3x60, 4x75, 5x80, 6x100, 7x100, 8x120, 9x120, 10x120mm



53859

69,00€

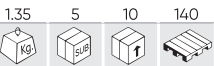

CONJUNTO BROCAS CRANEADAS COM ADAPTADORES



REPOSIÇÕES DISPONÍVEIS



22, 29, 35, 44, 51, 68mm



14-30, 32-152mm



54346

12,80€

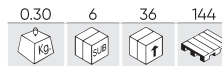

CONJUNTO DE 3 ESCOVAS DE LIMPEZA PARA BERBEQUIM

	1/4"	PP	ø 88mm
	1/4"	PP	ø 100mm
	1/4"	PP	ø 50mm



53857

29,00€

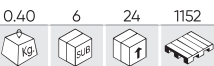

CONJUNTO DE PONTAS DE IMPACTO COM ADAPTADOR RÁPIDO S2



EM EXPOSITOR DE 6 UDS



53858

31,00€

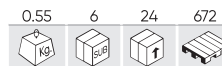

CONJUNTO DE PONTAS COM ADAPTADORES S2- REVESTIMENTO PRETO



EM EXPOSITOR DE 6 UDS



CONJUNTO DE BROCAS HELICOIDAIS HSS 4241 PRETO

REF.	PCS	MATERIAL	PARA	BROCAS					€
53851	170PCS	HSS-R 4241	Para metais	1-10mm	3.80	-	4	192	89,00€
53855	25PCS	HSS-R 4241	Para metais	1-13mm	1.19	5	10	192	27,50€
53853	19PCS	HSS-R 4241	Para metais	1-10mm	0.58	5	20	192	14,60€

53851



REPOSIÇÕES DISPONÍVEIS



1x34, 1.5x40, 2x49, 2.5x57, 3x61, 3.5x70, 4x75, 4.5x8, 5x86, 5.5x93, 6x93, 6.5x101, 7x109, 7.5x109, 8x117, 8.5x117, 9x125, 9.5x125, 10x133, 10.5x133, 11x142, 11.5x142, 12x151, 12.5x151, 13x151mm

53855



REPOSIÇÕES DISPONÍVEIS



1x34, 1.5x40, 2x49, 2.5x57, 3x61, 3.5x70, 4x75, 4.5x8, 5x86, 5.5x93, 6x93, 6.5x101, 7x109, 7.5x109, 8x117, 8.5x117, 9x125, 9.5x125, 10x133, 10.5x133, 11x142, 11.5x142, 12x151, 12.5x151, 13x151mm

53853



REPOSIÇÕES DISPONÍVEIS



1x34, 1.5x40, 2x49, 2.5x57, 3x61, 3.5x70, 4x75, 4.5x80, 5x86, 5.5x93, 6x93, 6.5x101, 7x109, 7.5x109, 8x117, 8.5x117, 9x125, 9.5x125, 10x133mm

CONJUNTO DE BROCAS HELICOIDAIS HSS 4341

REF.	PCS	MATERIAL	PARA	BROCAS					€
53852	170PCS	HSS-G 4341	Para metais	1-10mm	4.20	-	4	192	219,00€
53856	25PCS	HSS-G 4341	Para metais	1-13mm	1.32	5	10	550	67,00€
53854	19PCS	HSS-G 4341	Para metais	1-10mm	0.63	5	20	192	28,00€

53852



REPOSIÇÕES DISPONÍVEIS



1x34, 1.5x40, 2x49, 2.5x57, 3x61, 3.5x70, 4x75, 4.5x8, 5x86, 5.5x93, 6x93, 6.5x101, 7x109, 7.5x109, 8x117, 8.5x117, 9x125, 9.5x125, 10x133, 10.5x133, 11x142, 11.5x142, 12x151, 12.5x151, 13x151mm

53856



REPOSIÇÕES DISPONÍVEIS



1x34, 1.5x40, 2x49, 2.5x57, 3x61, 3.5x70, 4x75, 4.5x8, 5x86, 5.5x93, 6x93, 6.5x101, 7x109, 7.5x109, 8x117, 8.5x117, 9x125, 9.5x125, 10x133, 10.5x133, 11x142, 11.5x142, 12x151, 12.5x151, 13x151mm

53854



REPOSIÇÕES DISPONÍVEIS



1x34, 1.5x40, 2x49, 2.5x57, 3x61, 3.5x70, 4x75, 4.5x80, 5x86, 5.5x93, 6x93, 6.5x101, 7x109, 7.5x109, 8x117, 8.5x117, 9x125, 9.5x125, 10x133mm

CONJUNTO DE BROCAS HELICOIDAIS HSS-CO5 (COBALTO)

REF.	PCS	MATERIAL	PARA	BROCAS					€
54348	170PCS	HSS-CO5	Para metais	1-10mm	4.20	2	4	160	291,00€
54314	25PCS	HSS-CO5	Para metais	1-13mm	1.32	5	10	-	82,00€
54313	19PCS	HSS-CO5	Para metais	1-10mm	0.60	5	10	72	43,00€

54348



REPOSIÇÕES DISPONÍVEIS



1x34, 1.5x40, 2x49, 2.5x57, 3x61, 3.5x70, 4x75, 4.5x8, 5x86, 5.5x93, 6x93, 6.5x101, 7x109, 7.5x109, 8x117, 8.5x117, 9x125, 9.5x125, 10x133, 10.5x133, 11x142, 11.5x142, 12x151, 12.5x151, 13x151mm

54314



REPOSIÇÕES DISPONÍVEIS



1x34, 1.5x40, 2x49, 2.5x57, 3x61, 3.5x70, 4x75, 4.5x8, 5x86, 5.5x93, 6x93, 6.5x101, 7x109, 7.5x109, 8x117, 8.5x117, 9x125, 9.5x125, 10x133, 10.5x133, 11x142, 11.5x142, 12x151, 12.5x151, 13x151mm

54313



REPOSIÇÕES DISPONÍVEIS



1x34, 1.5x40, 2x49, 2.5x57, 3x61, 3.5x70, 4x75, 4.5x80, 5x86, 5.5x93, 6x93, 6.5x101, 7x109, 7.5x109, 8x117, 8.5x117, 9x125, 9.5x125, 10x133mm



15014

20,00€

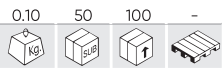

PORCA DE REMOÇÃO RÁPIDA M14 PARA REBARBADORA

M14 115-230mm



DISCO DE CORTE

PARA METAL

REF.	PARA	m/s	RPM										€
14893	60054	T42	80m/s	13300RPM	2.5mm	115mm	22.23mm	0.05	50	200	-	2,00€	
14894	60049	T42	80m/s	12200RPM	2.5mm	125mm	22.23mm	0.05	50	200	-	1,20€	
14895	60054	T27	80m/s	13300RPM	6mm	115mm	22.23mm	0.15	25	100	-	1,90€	
14896	60049	T27	80m/s	12200RPM	6mm	125mm	22.23mm	0.78	25	100	-	2,10€	



PARA AÇO INOXIDÁVEL

REF.	PARA	m/s	RPM										€
14897	60054	T41	80m/s	13300RPM	1mm	115mm	22.23mm	0.01	50	400	30000	0,88€	
14898	60049	T41	80m/s	12200RPM	1mm	125mm	22.23mm	0.03	50	400	30000	0,98€	
14899	60054	T41	80m/s	13300RPM	1.6mm	115mm	22.23mm	0.03	50	400	-	0,88€	
14900	60049	T41	80m/s	12200RPM	1.6mm	125mm	22.23mm	0.04	50	400	-	0,98€	



CONJUNTO DE PREGOS SEM CABEÇA

REF.	PCS	mm						€
53999	1000	25x1.25mm	0.20	-	50	5000	2,10€	
54000	1000	30x1.25mm	0.25	-	50	5000	2,50€	
54002	1000	38x1.25mm	0.30	-	50	5000	3,05€	



PARA REF. 60007 - 60010 - 60011 - 60019 - 60022



SERRA CIRCULAR

REF.	PARA	RPM			PARA					€
14985	60007 T24	7000RPM	165mm	20mm	Para madeira	0.25	20	40	2400	6,00€
14986	60011 T24	7000RPM	115mm	10mm	Para madeira	0.10	20	100	3600	4,00€
14987	60022 T40	7000RPM	185mm	25.4mm	Para madeira	0.30	20	40	2200	8,50€
14988	60007 T24	7000RPM	165mm	20mm	Para metal	0.25	20	40	2400	8,00€
14989	60011 T24	7000RPM	115mm	10mm	Para metal	0.10	20	100	3600	6,00€
14990	60022 T40	7000RPM	185mm	25.4mm	Para metal	0.30	20	40	2200	10,50€



14985 - 14988



14986 - 54989



14987 - 14990

LÂMINAS DE SERRA

REF.	PARA	CORTE			PARA					€
14991	60010 T244D	100mm	100mm	100mm	Para madeira	0.05	20	200	7200	2,00€
14993	60010 T118A	8mm	76mm	76mm	Para metal	0.05	20	200	7200	5,00€
14994	60019 6TPI	150mm	150mm	150mm	Para madeira	0.05	20	200	8400	3,50€
14995	60019 24TPI	10mm	150mm	150mm	Para metal	0.05	20	200	8400	8,00€



14991



14993



14994



14995

PARA REF. 60037



CONJUNTO DE GRAMPOS SEM CABEÇA

REF.	PCS	mm					€
54008	1000	25x6mm	0.45	-	40	4000	4,10€
54010	1000	30x6mm	0.55	-	40	4000	5,10€
54011	1000	38x6mm	0.65	-	40	4000	6,00€



PARA REF. 60061

ACESSÓRIOS

REF.	DESCRIÇÃO					€
17543	DISCO DE CORTE 76X1,2 MM REF. 60061	0.24	-	20	-	1,60€
17544	DISCO MÚLTIPLO DE CARBONETO 76X1,0 MM REF. 60061	0.68	-	20	-	5,00€
17545	DISCO DE CORTE DE DIAMANTE 76X1,6 MM REF. 60061	0.79	-	20	-	3,75€



17543



17544



17545

PARA REF. 60041

LÂMINAS DE SERRA

REF.	mm	MATERIAL	PARA					€
15680	20mm	Bimetal (HSS+HCS)	Para madeira maciça, madeira abrasiva e metais	0.02	40	240	30720	4,70€
15682	35mm	Bimetal (HSS+HCS)	Para madeira maciça, madeira abrasiva e metais	0.05	40	240	30720	4,70€
15683	35mm	Metal (HCS)	Para madeira	0.01	40	240	30720	2,50€
15684	64mm	carboneto de tungstênio	Para ferro, aço, telha, tijolo e vidro	0.02	20	120	8400	7,70€
15685	80mm	Bimetal (HSS+HCS)	Para madeira maciça, madeira abrasiva e metais	0.02	40	240	30720	9,50€
15686	88mm	Metal (HCS)	Para madeira	0.05	20	120	8400	3,70€



15680



15682



15683



15684



15685



15686

OUTROS

REF.	DESCRIÇÃO					€
15687	RASPADOR 50X72MM (REF. 60041)	0.10	40	240	30720	2,50€
15688	PACOTE DE 20 FOLHAS DE LIXAGEM 80X80X80MM - TAMANHO DO GRÃO 60/80/100/120/240 (REF.60041)	0.05	10	100	3600	5,30€
15689	LIXEIRA 79X79X79MM (REF. 60041)	0.05	10	100	3600	4,00€



15687



15688



15689



PARA REF. 60001

ACESSÓRIOS

REF.	DESCRIÇÃO					€
14950	A TUBO DE EXTENSÃO PARA REF. 60001	0.08	5	10	-	6,50€
14951	B BOCAL DE FENDA PARA REF. 60001	0.01	-	10	-	9,50€
14952	C BOCAL DE CHÃO REF. 60001	0.15	-	5	-	19,00€
14953	D ESCOVA PARA REF. 60001	0.05	-	10	-	8,50€



PARA REF. 60004

15049

37,40€



TRIPODE PARA FAROL DE TRABALHO LED (REF. 60004)

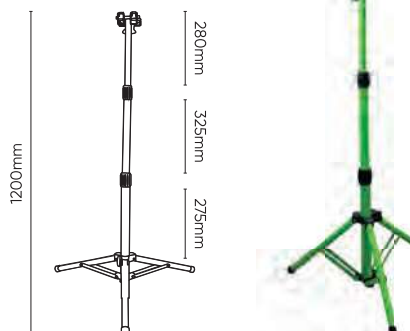

PARA REF. 60052

54586

5,00€

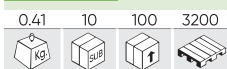

CONJUNTO DE 3 ADAPTADORES DE CHAVES DE CAIXA COM PONTA HEXAGONAL

x1	1/2"	73mm
x1	3/8"	65mm
x1	1/4"	65mm



PARA REF. 60056



17706

17,10€

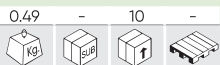

CORRENTE PARA MINISSERRA REF. 60056



ACESSÓRIOS

REF.	DESCRIÇÃO					€
14622	BANDEJA PARA REF. 60001, 60003, 60004, 60020, 60029, 60033, 60037, 60038	0.95	-	10	360	17,00€
14623	GANCHO PARA REF. 60043, 60042, 60046, 60051, 60052	0.10	-	10	800	8,00€
14624	BANDEJA PARA REF. 60007, 60010, 60011	0.65	-	10	300	17,00€
14625	GANCHO PARA REF. 60009, 60049, 60054	0.50	-	10	700	14,00€
14626	GANCHO PARA REF. 60023, 60032, 60044, 60047, 60050	0.10	-	10	-	7,00€
16364	CABIDE PONTA COMPRIDA 280MM	0.20	10	200	9999	3,50€



14622



14623



14624



14625



14626



16364



PÁGINA 471

PARA OBTER MAIS INFORMAÇÕES SOBRE OS NOSSOS EXPOSITORES DE FERRAMENTAS

Descubra a nossa variedade de expositores e os acessórios que incluem para melhorar e destacar a sua loja.

- 53877** EXPOSITOR DE FERRAMENTAS
- 53878** FERRAMENTA EXPOSITOR + CABEÇA COM ILUMINAÇÃO
- 53879** FERRAMENTA EXPOSITOR + CABEÇA COM ILUMINAÇÃO E PORTA

LUZES

LÂMPADAS DE INSPEÇÃO

152

PIRILAMPOS

163

LANTERNAS DE CABEÇA

156

LÂMPADA DE TRABALHO

166

GAMBIARRAS

159

SINALIZAÇÃO

170

FOCOS LED

160

ACESSÓRIOS E PEÇAS DE REPOSIÇÃO

172

ILUMINAÇÃO DE CAPÔ

161



GAMBIARRA COM BASE MAGNÉTICA ARTICULADA

54122

38,00€

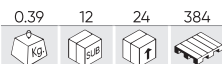

54123

40,00€

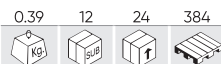

54124

47,00€

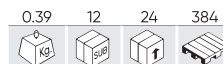

EM EXPOSITOR DE 12 UDS

	54122	54123	54124
Brilho	300Lm	500Lm	1000Lm
Potência	3W	3-5W	3-10W
Tensão	3,7V	3,8V	3,7V
Tipo de LED	XPE, COB	XPE, COB	XPE, COB
Modos de iluminação	2	2	2
Tipo de pilha	LI-ION	LI-ION	LI-ION
Capacidade da bateria	2000mAh	4000mAh	4000mAh
Tempo de trabalho	2,5-7h	3-14h	3-14h
Tempo de carregamento	3-4h	3-4h	6-8h
Método de carregamento	USB C	USB C	USB C
Tipo	Recargable/Rechargeable	Recargable/Rechargeable	Recargable/Rechargeable
Magnetizado	Si/Yes	Si/Yes	Si/Yes
Proteção IP	IP44	IP44	IP44
Peso	0,39Kg	0,39Kg	0,39Kg
Dimensões (CxLxA)	257x50x26mm	257x50x26mm	257x50x26mm

53734

19,80€

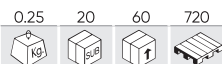

LÂMPADA LED COM BASE ARTICULADA E IMAN - 400LM

Brilho	30-400Lm
Potência	9,62W
Tensão	3,7V
Tipo de LED	COB
Modos de iluminação	1
Intensidade de luz regulável	Si/Yes
Tipo de pilha	LI-ION
Capacidade da bateria	2600mAh
Tempo de trabalho	2,5h (400Lm), 10h (30Lm)
Tempo de carregamento	3-4h
Método de carregamento	USB C
Tipo	Recargable/Rechargeable
Magnetizado	Si/Yes
Proteção IP	IP44
Peso	1,77Kg
Dimensões (CxX)	380x32mm



EM EXPOSITOR DE 20 UDS

54600

26,00€

0.16 20 40 1920



MINI LÂMPADA LED ARTICULADA IMANTADA - 360LM

Brilho	120-360Lm
Potência	3-5W
Tensão	3,7V
Tipo de LED	XPE, COB
Modos de iluminação	2
Tipo de pilha	LI-ION
Capacidade da bateria	2000mAh
Tempo de trabalho	3-4h
Tempo de carregamento	3,5h
Método de carregamento	USB C
Tipo	Recargable/Rechargeable
Magnetizado	Si/Yes
Proteção IP	IPX2
Peso	0,16Kg
Dimensões (CxLxA)	150x38x31mm

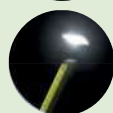
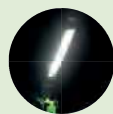

EM EXPOSITOR DE 20 UDS

54601

30,50€

0.21 10 20 1260



LÂMPADA LED REGULÁVEL ARTICULADA COM BASE IMANTADA - 400LM

Brilho	160-400Lm
Potência	3-5W
Tensão	3,7V
Tipo de LED	XPE, COB
Modos de iluminação	2
Intensidade de luz regulável	Si/Yes
Tipo de pilha	LI-ION
Capacidade da bateria	2000-4000Ah
Tempo de trabalho	3-4h
Tempo de carregamento	3h
Método de carregamento	USB C
Tipo	Recargable/Rechargeable
Magnetizado	Si/Yes
Proteção IP	IPX2
Peso	0,21Kg
Dimensões (CxLxA)	150x48x39mm



EM EXPOSITOR DE 12 UDS

54599

28,00€

0.12 20 40 1800



LÂMPADA LED ULTRAFINA DOBRÁVEL - 500LM

Brilho	100-500Lm
Potência	3-10W
Tensão	5V
Tipo de LED	COB, SMD
Modos de iluminação	2
Tipo de pilha	LI-ION
Capacidade da bateria	800mAh
Tempo de trabalho	1,5-3h
Tempo de carregamento	1,5h
Método de carregamento	USB C
Tipo	Recargable/Rechargeable
Magnetizado	Si/Yes
Escurecimento	IPX2
Proteção IP	Si/Yes
Peso	0,10Kg
Dimensões (CxLxA)	176x22x38,5mm



EM EXPOSITOR DE 20 UDS

54567

29,00€

0.25	20	60	-

LÂMPADA LED ULTRAVIOLETA REGULÁVEL COM BASE IMANTADA ARTICULADA - 500LM

Brilho	60-500Lm
Potência	5W
Tensão	3,7V
Tipo de LED	COB, SMD, UV
Modos de iluminação	4
Intensidade de luz regulável	Si/Yes
Tipo de pilha	LI-ION
Capacidade da bateria	2200mAh
Tempo de trabalho	2-2,5-6-21,5h
Tempo de carregamento	3H
Método de carregamento	USB C
Tipo	Recargable/Rechargeable
Magnetizado	Si/Yes
Peso	0,20Kg
Dimensões (CxLxA)	42x35x383mm



EM EXPOSITOR DE 20 UDS

53776

19,10€

0.15	12	48	1872

MINI LÂMPADA LED COM BASE ARTICULADA E IMAN - 300LM

Brilho	90-300Lm
Potência	3-5W
Tensão	3,7V
Tipo de LED	XPE, COB
Modos de iluminação	3
Tipo de pilha	LI-ION
Capacidade da bateria	1500mAh
Tempo de trabalho	3,5-6h
Tempo de carregamento	2,5h
Método de carregamento	Micro USB
Tipo	Recargable/Rechargeable
Magnetizado	Si/Yes
Peso	0,15Kg
Dimensões (CxLxA)	140x73x23mm



EM EXPOSITOR DE 12 UDS

53216

49,00€

0.60	-	10	180

LÂMPADA LED PORTÁTIL COM BASE ARTICULADA E IMAN - 170LM

Brilho	170Lm
Potência	2W
Tensão	3,7-5V
Tipo de LED	XPE, COB
Modos de iluminação	2
Tipo de pilha	LI-ION
Capacidade da bateria	2000mAh
Tempo de trabalho	3-4h
Tempo de carregamento	4-5h
Método de carregamento	Micro USB
Magnetizado	Si/Yes
Peso	0,60Kg
Dimensões (CxX)	390x100mm



53519

42,00€

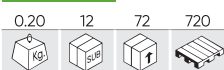

LÂMPADA LED EXTRA FINA COM BASE ARTICULADA E IMAN - 300LM

Brilho	150-300Lm
Potência	3W
Tensão	3,7V
Tipo de LED	XPE, COB
Modos de iluminação	2
Tipo de pilha	LI-POLI
Capacidade da bateria	800mAh
Tempo de trabalho	2h
Tempo de carregamento	3h
Método de carregamento	Recargable/Rechargeable
Tipo	USB
Magnetizado	Si/Yes
Proteção IP	IP44
Peso	0,20Kg
Dimensões (CxLxA)	300x38x12mm



EM EXPOSITOR DE 12 UDS



52536

57,00€



LÂMPADA LED PORTÁTIL SLIM - 200LM

Brilho	200Lm
Potência	2W
Tensão	3,7V
Tipo de LED	XPE, COB
Modos de iluminação	2
Tipo de pilha	LI-ION
Capacidade da bateria	1900mA
Tempo de trabalho	3,5-5h
Tempo de carregamento	4h
Método de carregamento	Cargador/Charger
Tipo	Recargable/Rechargeable
Magnetizado	Si/Yes
Peso	0,40Kg
Dimensões (CxA)	360x50mm

 DISEÑO REGISTRADO
REGISTERED DESIGN



51889

49,00€

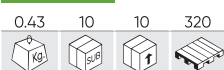

LÂMPADA LED PORTÁTIL ARTICULADA COM DUPLO ÍMAN - 60LM

Brilho	60Lm
Potência	2W
Tensão	3,6V
Tipo de LED	XPE
Modos de iluminação	2
Tipo de pilha	LI-ION
Capacidade da bateria	2200mAh
Tempo de trabalho	5h
Tempo de carregamento	3-4h
Método de carregamento	Cargador/Charger
Tipo	Recargable/Rechargeable
Magnetizado	Si/Yes
Peso	0,43Kg
Dimensões (CxA)	255x56mm



54344

10,50€

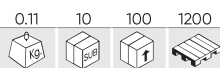

GORRO COM LANTERNA LED - 120LM



Brilho	25-60-120Lm
Potência	1W
Tensão	3,7V
Modos de iluminação	3
Tipo de pilha	LI-ION
Capacidade da bateria	250mAh
Tempo de trabalho	40min, 6-8h, 8-10h
Tempo de carregamento	2h
Método de carregamento	USB A
Magnetizado	No
Proteção IP	IP3X
Peso	0,10Kg
Dimensões (CxLxA)	210x220x20mm

52987

20,00€

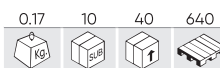

LÂMPADA LED DE BOLSO - 120LM



EM EXPOSITOR DE 10 UDS



Brilho	120Lm
Potência	4W
Tensão	3,7V
Tipo de LED	COB
Tipo de pilha	LI-ION
Capacidade da bateria	1000mAh
Tempo de trabalho	2,5h
Tempo de carregamento	1h
Método de carregamento	Micro USB
Magnetizado	Si/Yes
Peso	0,17Kg
Dimensões (CxLxA)	160x30x20mm

53780

14,50€

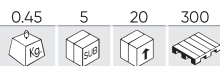

LÂMPADA LED - 400LM

Brilho	400Lm
Potência	6W
Tensão	220-240V
Tipo de LED	COB
Proteção IP	IP20
Peso	0,45Kg
Dimensões (CxLxA)	450x40x30mm



52384

29,00€



LÂMPADA LED EXTRA PLANA - 200LM

Brilho	200Lm
Potência	3W
Tensão	12-24V
Tipo de LED	COB
Peso	0,33Kg
Dimensões (CxLxA)	325x90mm



53217

47,00€



LÂMPADA LED DE ARTICULAÇÃO FLEXÍVEL COM BASE IMANTADA - 200LM

Brilho	200Lm
Tensão	5V
Tipo de LED	XPE, COB
Tipo de pilha	LI-ION
Capacidade da bateria	2200mAh
Tempo de trabalho	4h
Tempo de carregamento	4h
Método de carregamento	Micro USB
Magnetizado	Si/Yes
Peso	0,30Kg
Dimensões (CxLxA)	120x40x265mm



54379

28,00€

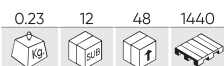

FOCO LED PORTÁTEIS COM BASE IMANTADA E CARREGAMENTO SOLAR - 800LM



EM EXPOSITOR DE 12 UDS

Brilho	80-800Lm
Potência	3-10W
Tensão	5,2V
Tipo de LED	XPE, COB
Modos de iluminação	4
Tipo de pilha	LI-ION
Capacidade da bateria	4-12h
Tempo de carregamento	3,5h
Método de carregamento	Solar, USB C
Tipo	Recargable/Rechargeable
Magnetizado	Si/Yes
Inclui	USB C
Peso	0,23Kg
Dimensões (CxLxA)	140x73x20mm

54004

16,00€



LANTERNA FRONTAL LED AJUSTÁVEL - 350LM



EM EXPOSITOR DE 12 UDS

Brilho	150-350Lm
Potência	3-5W
Tensão	2,5-4,17V
Tipo de LED	XPE, COB
Modos de iluminação	3
Tipo de pilha	LI-ION
Capacidade da bateria	1.200mAh
Tempo de trabalho	2,5-4h
Tempo de carregamento	2,5h
Inclui	USB C
Peso	0,70Kg
Dimensões (CxLxA)	300x32x20mm

53569

18,00€

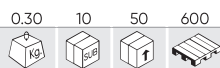

LANTERNA LED FRONTAL - 800LM

Brilho	800Lm
Potência	5W
Tensão	3,7V
Tipo de LED	CREE, COB
Modos de iluminação	3
Tipo de pilha	CN18650
Capacidade da bateria	3500mAh
Tempo de trabalho	2,5h
Tempo de carregamento	3,5-4h
Peso	0,30Kg
Dimensões (CxLxA)	116x100x110mm



54267

9,50€

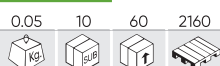

LUVA COM LANTERNA LED - 70LM

Brilho	70Lm
Potência	120mAh
Tensão	3V
Tipo de LED	XPE
Número de LEDs	6
Peso	0,05Kg
Dimensões (CxLxA)	160x32mm



53974

38,00€

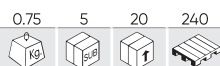

FOCO LED RECARREGÁVEIS - 1500LM

Brilho	1500Lm
Potência	20W
Tensão	3,7V
Tipo de LED	COB
Número de LEDs	51
Feixe de luz	Dispersa/Scattered
Tempo de trabalho	2,5h
Tempo de carregamento	5-6h
Método de carregamento	USB
Material	2
Modos de iluminação	ABS
Proteção IP	IP54
Peso	0,75Kg
Dimensões (CxLxA)	240x225x37mm



54544

0.37	12	48	672

LANTERNA LED MULTIFUNCIONAL DE 800LM

Brilho	800Lm
Potência	10W
Tensão	3,7V
Tipo de LED	LEP
Capacidade da bateria	13
Número de LEDs	2800mAh
Método de carregamento	USB C
Magnetizado	No
Peso	0,36Kg
Dimensões (CxLxA)	185x53x37mm



VÍDEO TUTORIAL



EM EXPOSITOR DE 12 UDS



50,50€

53427

5,00€

0.05	12	96	3456

MINI LANTERNA LED DE BOLSO COM BASE IMANTADA - 45LM



EM EXPOSITOR DE 12 UDS



Brilho	45Lm
Potência	0,5W
Tensão	1,5V
Tipo de LED	XPE
Número de LEDs	6
Método de carregamento	Pila/Battery AAA
Magnetizado	Si/Yes
Peso	0,05Kg
Dimensões (CxLxA)	160x32mm

51573

2,50€

0.07	12	96	3168

LANTERNA LED COM DÍNAMO - 6LM



Brilho	6Lm
Tensão	4,5V
Tipo de LED	XPE
Número de LEDs	2
Método de carregamento	Dinamo/Dynamo
Magnetizado	No
Peso	0,07Kg
Dimensões (CxLxA)	105x58mm

52558

2,55€

0.03	48	192	3072

MINI LANTERNA LED 27LM - PRETO



EM EXPOSITOR DE 12 UDS



Brilho	27Lm
Tensão	1,5V
Tipo de LED	XPE
Número de LEDs	9
Tipo de pilha	Pila/Battery AAA
Magnetizado	No
Peso	0,03Kg
Dimensões (CxLxA)	96x26mm

52555

2,55€

0.03	48	192	3456

MINI LANTERNA LED 27LM - VERDE



EM EXPOSITOR DE 12 UDS



Brilho	27Lm
Tensão	1,5V
Tipo de LED	XPE
Número de LEDs	9
Tipo de pilha	Pila/Battery AAA
Magnetizado	No
Peso	0,03Kg
Dimensões (CxLxA)	30x93mm

51326

5,80€

0.07	12	144	2880

MINI LANTERNA LED - 63LM



EM EXPOSITOR DE 12 UDS



Brilho	63Lm
Tensão	9V
Tipo de LED	XPE
Número de LEDs	21
Tipo de pilha	Pila/Battery AAA
Magnetizado	No
Peso	0,07Kg
Dimensões (CxLxA)	95x35mm

53085

32,00€

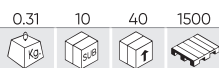

LUPA 8 LED

Número de LEDs	8
Método de carregamento	x2 AA
Peso	0,31Kg
Dimensões (CxLxA)	210x100x35mm



53505

77,00€

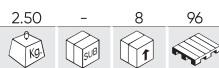

FOCO LED - 3500LM

Brilho	3500Lm
Potência	50W
Tensão	230V
Número de LEDs	60
Tempo de trabalho	+25000h
Comprimento do cabo	2m
Proteção IP	IP65
Peso	2,50Kg
Dimensões (CxLxA)	328x235x41mm



TRIPÉ PARA FOCO LED

REF.	DESCRIÇÃO	MAX.	MIN.					€
53506	TRIPÉ PARA FOCO LED (REF.53505)	1830mm	840mm	2.40	-	8	112	36,00€
52254	TRIPÉ PARA FOCO PARA REF. 52232 - CINZENTO	2770mm	1290mm	3.51	-	4	24	64,00€

54133

547,00€



CONJUNTO DE 6 LÂMPADAS LED INDUSTRIAIS - 20000LM (REF. 54039)



Peças	6
Brilho	20000Lm
Potência	200W
Tensão	220V
Tipo de LED	MTC
Número de LEDs	288
Comprimento do cabo	300mm
Proteção IP	IP20
Peso	12,10Kg
Dimensões (CxX)	500x380mm

54039

154,00€



LÂMPADA LED INDUSTRIAL - 20000LM



Peças	1
Brilho	20000Lm
Potência	200W
Tensão	220V
Tipo de LED	MTC
Número de LEDs	288
Comprimento do cabo	300mm
Proteção IP	IP20
Peso	2,60Kg
Dimensões (CxX)	500x380mm

54088

132,00€

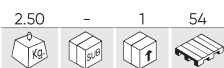

LÂMPADA LED INDUSTRIAL - 18000LM

Brilho	18000Lm
Potência	150W
Tensão	100-277V
Tipo de LED	SMD2835
Número de LEDs	240
Comprimento do cabo	400mm
Proteção IP	IP65
Peso	2,50Kg
Dimensões (CxLxA)	300x150mm



54500

159,00€



BARRA LED AJUSTÁVEL PARA CAPÔ - 5000LM

Brilho	5000Lm
Potência	33W
Tensão	7,2V
Tipo de LED	XPE, SMD
Modos de iluminação	3
Capacidade da bateria	5000mAh
Tempo de trabalho	3-15h
Método de carregamento	USB C
Abertura	1180-1720mm
Peso	1,75Kg
Dimensões (CxLxA)	1172x50x20mm



VÍDEO TUTORIAL

54270

42,00€

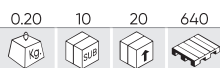

BARRA LED IMANTADA FLEXÍVEL - 1000LM

Brilho	1000Lm
Potência	10W
Tensão	3,7V
Tipo de LED	COB
Modos de iluminação	2
Tipo de pilha	LI-ION
Capacidade da bateria	1200mAh
Tempo de trabalho	2-5h
Tempo de carregamento	3-4h
Método de carregamento	USB C
Magnetizado	Si/Yes
Peso	0,20Kg
Dimensões (CxLxA)	580x37x22mm



54271

54,00€

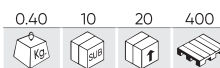

BARRA LED IMANTADA FLEXÍVEL COM CINTA - 1000LM

Brilho	1000Lm
Potência	10W
Tensão	3,7V
Tipo de LED	COB
Modos de iluminação	2
Tipo de pilha	LI-ION
Capacidade da bateria	1200mAh
Tempo de trabalho	2-5h
Tempo de carregamento	3-4h
Método de carregamento	USB C
Magnetizado	Si/Yes
Abertura	1200-1800mm
Peso	0,33Kg
Dimensões (CxLxA)	1800x37x22mm

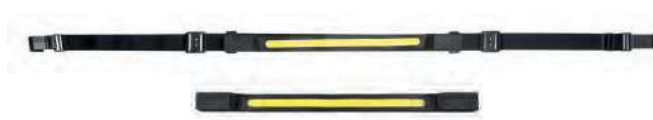

53707

153,00€



LÂMPADA LED PARA CAPÔ IMANTADA - 1200LM

Brilho	1200Lm
Potência	10,92W
Tensão	4,2V
Tipo de LED	COB
Modos de iluminação	3
Tipo de pilha	LI-ION
Capacidade da bateria	5200mAh
Tempo de trabalho	6h
Tempo de carregamento	7-8h
Método de carregamento	Micro USB
Magnetizado	Si/Yes
Peso	2,25Kg
Dimensões (CxLxA)	1050x80x70mm



53570

154,00€



LÂMPADA LED PARA CAPÔ - 1200LM

Brilho	1200Lm
Potência	10,92W
Tensão	3,7V
Tipo de LED	COB
Modos de iluminação	3
Tipo de pilha	LI-ION
Capacidade da bateria	2600mAh
Tempo de trabalho	3-7h
Tempo de carregamento	7-8h
Método de carregamento	Micro USB
Magnetizado	No
Peso	2,70Kg
Dimensões (CxLxA)	1180x110x120mm



54173 87,00€

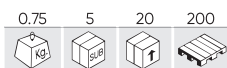

LUZ DE EMERGÊNCIA LED RECARREGÁVEL COM BASE MAGNÉTICA



Indica corretamente a posição do veículo. Graças à sua bateria integrada, pode ser utilizado de duas maneiras: ligado a um cabo de alimentação ou sem cabo.

Brilho	473,62Lm
Potência	13W
Tensão	5V
Tipo de LED	SMD2835
Modos de iluminação	3
Tipo de pilha	LI-ION Recargable/Rechargeable
Capacidade da bateria	7,4V - 2200mAh
Tempo de trabalho	3-4h
Tempo de carregamento	2-3h
Método de carregamento	USB
Magnetizado	Si/Yes
Material	PC, ABS
Temperatura de trabalho	-30~50°C
Peso	0,77Kg
Dimensões (CxLxA)	128x128x140mm

54172 81,00€

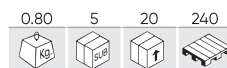

LUZ DE EMERGÊNCIA RECARREGÁVEL COM BASE FLEXÍVEL



Brilho	447,07Lm
Potência	13W
Tensão	5V
Tipo de LED	SMD2835
Modos de iluminação	3
Tipo de pilha	LI-ION Recargable/Rechargeable
Capacidade da bateria	2200mAh
Tempo de trabalho	3-4h
Tempo de carregamento	2-3h
Método de carregamento	USB
Magnetizado	No
Material	PC, ABS
Temperatura de trabalho	-30~50°C
Peso	0,83Kg
Dimensões (CxLxA)	128x128x210mm

53691 36,00€



LUZ DE EMERGÊNCIA LED MAGNÉTICO

Potência	18W	Material	PC, PPB
Tensão	12-24V	Temperatura de trabalho	-30~50°C
Tipo de LED	3030SMD	Peso	0,70Kg
Magnetizado	Si/Yes	Dimensões (CxLxA)	125x112mm



53690 34,00€

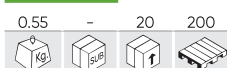

LUZ DE EMERGÊNCIA LED 12-24V BASE FLEXÍVEL

Potência	18W	Temperatura de trabalho	-30~50°C
Tensão	12-24V	Peso	0,70Kg
Tipo de LED	3030SMD	Dimensões (CxLxA)	125x182mm
Material	PC, PPB, TPR		



52375 38,00€



LUZ DE EMERGÊNCIA LED 12-24V - MÓDULO P/PISCAR LED

Brilho	230,64Lm	Modos de iluminação	3	Temperatura de trabalho	-30~50°C
Potência	21,3W	Comprimento do cabo	2,5m	Peso	0,58Kg
Tensão	12-24V	Magnetizado	Si/Yes	Dimensões (CxLxA)	140x140x170mm
Tipo de LED	SMD5730	Material	PC, ABS		



52456

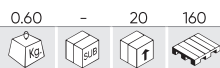

LUZ DE EMERGÊNCIA LED 12-24V BASE FLEXÍVEL

Brilho	227,04Lm	Modos de iluminação	6	Temperatura de trabalho	-30~50°C
Potência	21W	Magnetizado	Si/Yes	Peso	0,60Kg
Tensão	12-24V	Material	PC, ABS	Dimensões (CxLxA)	128x128x240mm

36,00€



51964

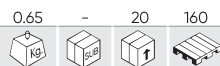

LUZ DE EMERGÊNCIA C/BASE FLEXÍVEL H1 12V 55W

Brilho	300,93Lm	Bolbo	H1	Temperatura de trabalho	-30~50°C
Potência	43,5W	Magnetizado	No	Peso	0,60Kg
Tensão	12V	Material	PC, ABS	Dimensões (CxLxA)	128x128x240mm

28,00€



51965



LUZ DE EMERGÊNCIA COM BASE FLEXÍVEL H1 24V 70W

Brilho	293,43Lm	Bolbo	H1	Temperatura de trabalho	-30~50°C
Potência	41,74W	Magnetizado	No	Peso	0,60Kg
Tensão	24V	Material	PC, ABS	Dimensões (CxLxA)	128x128x240mm

34,00€



51962

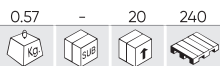

LUZ DE EMERGÊNCIA SEM CABO H1 12V 55W

Brilho	269,20Lm	Bolbo	H1	Temperatura de trabalho	-30~50°C
Potência	33,8W	Magnetizado	No	Peso	0,45Kg
Tensão	12V	Material	PC, ABS	Dimensões (CxLxA)	140x140x155mm

25,00€



51963



LUZ DE EMERGÊNCIA SEM CABO H1 24V 70W

Brilho	324,46Lm	Bolbo	H1	Temperatura de trabalho	-30~50°C
Potência	33,62W	Magnetizado	No	Peso	0,50Kg
Tensão	24V	Material	PC, ABS	Dimensões (CxLxA)	140x140x170mm

29,50€



51960

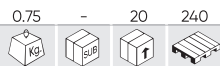

LUZ DE EMERGÊNCIA COM CABO MAGNÉTICO H1 12V-55W

Brilho	299Lm	Comprimento do cabo	2,5m	Temperatura de trabalho	-30~50°C
Potência	43,84W	Magnetizado	Si/Yes	Peso	0,64Kg
Tensão	12V	Material	PC, ABS	Dimensões (CxLxA)	140x140x170mm

34,00€



51961

39,00€

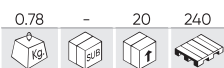

LUZ DE EMERGÊNCIA COM CABO COM IMÁN H1 24V 70W

Brilho	335,13Lm	Comprimento do cabo	2,5m	Temperatura de trabalho	-30~50°C
Potência	33,55W	Magnetizado	Si/Yes	Peso	0,64Kg
Tensão	24V	Material	PC, ABS	Dimensões (CxLxA)	140x140x170mm
Bolbo	H1				



51966

18,00€



LUZ DE EMERGÊNCIA TIPO FLASH 12V-110V

Brilho	57,75Lm	Bolbo	Xenon	Temperatura de trabalho	-30~50°C
Potência	9,12W	Magnetizado	No	Peso	0,28Kg
Tensão	12-110V	Material	PC, ABS	Dimensões (CxLxA)	161x161x131mm



LUZ DE EMERGÊNCIA TIPO FLASH DE LEDS

REF.	DESCRIÇÃO				€
52827	LUZ DE EMERGÊNCIA TIPO FLASH DE LEDS - AMBAR	0.50	-	20 400	46,00€
52828	LUZ DE EMERGÊNCIA PERFIL BAIXO TIPO FLASH ROTATIVO	0.54	-	20 320	46,00€
52910	LUZ DE EMERGÊNCIA TIPO FLASH DE LEDS	0.50	-	20 320	46,00€



52827



52828



52910

ACESSÓRIOS

REF.	DESCRIÇÃO				€
10750	CONECTOR PARA LUZ DE EMERGÊNCIA REF. 51964, 51965, 52456	0.25	-	50 1200	17,90€
10751	CONECTOR PARA LUZ DE EMERGÊNCIA REF. 51964, 51965 E 52456	0.30	-	50 -	18,40€
52843	CABO EXTENSÍVEL MULTIFUNÇÃO	0.90	-	20 1500	33,50€
51969	CÚPULA DE LUZ DE EMERGÊNCIA LARANJA PARA REF. 51960, 51961, 51964	0.12	-	50 1000	14,00€
11324	CÚPULA AZUL DE LUZ DE EMERGÊNCIA PARA REF. 51960, 51961, 51964	0.13	-	100 -	17,50€
11325	CÚPULA DE LUZ DE EMERGÊNCIA ROJO PARA REF. 51960, 51961, 51964	0.12	-	50 451	17,50€



10750



10751



52843



51969



11324



11325

53428

18,00€

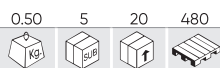

FOCO LED DE 1800LM - QUADRADO

Brilho	1800Lm
Potência	27W
Tensão	10-30V
Tipo de LED	SMD
Número de LEDs	9
Feixe de luz	Dispersa/Scattered
Material	Aluminio/Aluminium
Proteção IP	IP67
Peso	0,50Kg
Dimensões (CxLxA)	126x48x108mm



53429

18,00€

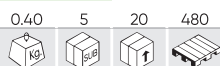

FOCO LED DE 1800LM - REDONDO

Brilho	1800Lm
Potência	27W
Tensão	10-20V
Tipo de LED	SMD
Número de LEDs	9
Feixe de luz	Dispersa/Scattered
Material	Aluminio/Aluminium
Proteção IP	IP68
Peso	0,40Kg
Dimensões (CxLxA)	115x48x128mm



52566

28,00€

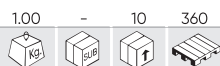

FOCO LED DE 1450LM - QUADRADO

Brilho	1450Lm
Potência	27W
Tensão	10-40V
Tipo de LED	3W LED
Número de LEDs	9
Feixe de luz	Dispersa/Scattered
Material	Aluminio/Aluminium
Proteção IP	IP68
Peso	1,00Kg
Dimensões (CxLxA)	117x55x160mm



52567

29,00€



FOCO LED DE 1450LM - REDONDO

Brilho	1450Lm
Potência	27W
Tensão	10-40V
Tipo de LED	3W LED
Número de LEDs	9
Feixe de luz	Dispersa/Scattered
Material	Aluminio/Aluminium



Proteção IP	IP68
Peso	0,90Kg
Dimensões (CxLxA)	127x45x170mm

52302

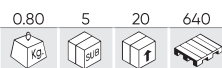

FOCO LED DE 1450LM - QUADRADO

Brilho	1450Lm
Potência	27W
Tensão	10-40V
Tipo de LED	3W
Número de LEDs	9
Feixe de luz	Dispersa/Scattered
Tempo de trabalho	20000h
Material	Aluminio/Aluminum



Proteção IP	IP68
Peso	0,76Kg
Dimensões (CxLxA)	125x50x137mm

25,40€

52303

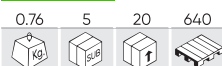

FOCO LED DE 1450LM - REDONDO

Brilho	1450Lm
Potência	27W
Tensão	10-40V
Tipo de LED	3W
Número de LEDs	9
Feixe de luz	Dispersa/Scattered
Tempo de trabalho	20000h
Material	Aluminio/Aluminum



Proteção IP	IP68
Peso	0,76Kg
Dimensões (CxLxA)	125x50x137mm

28,50€

53049

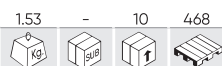

FAROL DE LED 3600LM - QUADRADO

Brilho	3600Lm
Potência	40W
Tensão	9-36V
Tipo de LED	10W
Número de LEDs	4
Feixe de luz	Dispersa/Scattered
Material	Aluminio/Aluminium
Proteção IP	IP68
Peso	1,53Kg
Dimensões (CxLxA)	123x87x117mm



89,00€

53052



FAROL LED DE 7200LM - REDONDO

Brilho	7200Lm
Potência	80W
Tensão	9-36V
Tipo de LED	5W
Número de LEDs	8
Feixe de luz	Dispersa/Scattered
Material	Aluminio/Aluminium
Proteção IP	IP68
Peso	2,65Kg
Dimensões (CxLxA)	165x98x191,5mm



158,00€

53045

35,00€

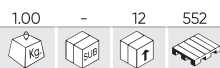

FAROL DE LED 2800LM - QUADRADO

Brilho	2800Lm
Potência	48W
Tensão	10-40V
Tipo de LED	3W
Número de LEDs	16
Feixe de luz	Dispersa/Scattered
Material	Aluminio/Aluminium
Proteção IP	IP67
Peso	1,00Kg
Dimensões (CxLxA)	130x55x150mm



53046

39,00€



FAROL DE LED 2272LM - QUADRADO

Brilho	2272Lm
Potência	24W
Tensão	9-36V
Tipo de LED	1,5W
Número de LEDs	16
Feixe de luz	Dispersa/Scattered
Material	Aluminio/Aluminium
Proteção IP	IP68
Peso	0,74Kg
Dimensões (CxLxA)	129x131,5x45mm



52568

28,00€

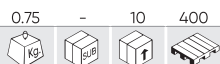

FOCO LED DE 1450LM - QUADRADO

Brilho	1450Lm
Potência	27W
Tensão	10-40V
Tipo de LED	3W
Número de LEDs	9
Feixe de luz	Concentrada/Concentrated
Tempo de trabalho	20000h
Material	Aluminio/Aluminium
Proteção IP	IP68
Peso	0,70Kg
Dimensões (CxLxA)	125x50x137mm



52569

28,00€

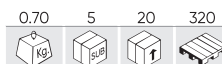

FOCO LED DE 1450LM - REDONDO

Brilho	1450Lm
Potência	27W
Tensão	10-40V
Tipo de LED	3W
Número de LEDs	9
Feixe de luz	Concentrada/Concentrated
Tempo de trabalho	20000h
Material	Aluminio/Aluminium
Proteção IP	IP68
Peso	0,75Kg
Dimensões (CxLxA)	107x127x50mm



53048

89,00€

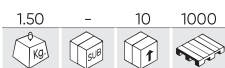

FAROL DE LED 3600LM - QUADRADO

Brilho	3600Lm
Potência	40W
Tensão	9-36V
Tipo de LED	10W
Número de LEDs	4
Feixe de luz	Concentrado/Concentrated
Material	Aluminio/Aluminium
Proteção IP	IP68
Peso	1,50Kg
Dimensões (CxLxA)	123x87x118mm



53051

158,00€



FAROL LED DE 7200LM - REDONDO

Brilho	7200Lm
Potência	80W
Tensão	9-36V
Tipo de LED	10W
Número de LEDs	8
Feixe de luz	Concentrada/Concentrated
Material	Aluminio/Aluminium
Proteção IP	IP68
Peso	2,75Kg
Dimensões (CxLxA)	165x95x191,5mm



52415

19,00€

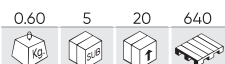

FOCO LED DE 1450LM - QUADRADO

Brilho	1450Lm
Potência	27W
Tensão	10-40V
Tipo de LED	3W
Número de LEDs	9
Feixe de luz	Concentrada/Concentrated
Tempo de trabalho	20000h
Material	Aluminio/Aluminium



Proteção IP	IP68
Peso	0,60Kg
Dimensões (CxLxA)	110x50x128mm

52414

19,00€



FOCO LED DE 1450LM - REDONDO

Brilho	1450Lm
Potência	27W
Tensão	10-40V
Tipo de LED	3W
Número de LEDs	9
Feixe de luz	Concentrada/Concentrated
Tempo de trabalho	20000h
Material	Aluminio/Aluminium



Proteção IP	IP68
Peso	0,55Kg
Dimensões (CxLxA)	118x128x50mm



53047

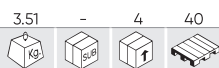

FOCO LED REGULÁVEIS DE LUZ FOCADA - 3200LM

Brilho	3200Lm
Potência	80W
Tensão	12-24V
Tipo de LED	5W
Número de LEDs	10
Feixe de luz	Concentrada/Concentrated
Magnetizado	Si/Yes

330,00€



Material	Aluminio/Aluminium
Proteção IP	IP67
Peso	3,51Kg
Dimensões (CxLxA)	185x150x230mm

SINALIZADOR LED PARA BARRA DE REBOQUE

REF.	Kg	Box	Box	Box	€
54160L	0.20	5	20	880	19,00€
54160R	0.20	5	20	880	19,00€



54044

99,00€



CONJUNTO DE DUAS LUZES TRASEIRAS MAGNÉTICAS SEM FIO



Tensão	12-24V
Tempo de carregamento	2-3h
Magnetizado	Si/Yes
Sem fios	20m
Número PIN	7
Peso	1,15Kg
Dimensões (CxLxA)	98x30x108mm

53151

14,00€

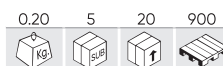

SINALIZADOR LED PARA BARRA DE REBOQUE



Potência	1,05W
Tensão	12V
Modos de iluminação	4
Magnetizado	No
Temperatura de trabalho	-30~50°C
Peso	0,11Kg
Dimensões (CxA)	106x98mm

54161

99,00€



BARRA DE SINALIZAÇÃO PARA REBOQUES DE 1,4 A 2.1M



Tensão	12-24V
Modos de iluminação	4
Comprimento do cabo	7,5m
Número PIN	7
Peso	2,00Kg

54163

80,00€



BARRA DE SINALIZAÇÃO PARA REBOQUE DE 1.100X140MM COM 2 SINALIZADORES LED E 2 TRIÂNGULOS REFLETORES



Tensão	12-24V
Modos de iluminação	4
Comprimento do cabo	5m
Número PIN	7
Peso	1,85Kg

50910

45,00€



BARRA DE SINALIZAÇÃO PARA REBOQUE DE 1100X140MM COM 2 FAROLINS, 2 TRIÂNGULOS REFLECTORES



Potência	4,96W
Tensão	12V
Modos de iluminação	4
Comprimento do cabo	5m
Magnetizado	No
Temperatura de trabalho	-30~50°C
Número PIN	7
Peso	1,75Kg
Dimensões (CxLxA)	1100x140mm

52838

56,00€



BARRA DE SINALIZAÇÃO PARA REBOQUE DE 1.100X140MM COM 2 FAROLINS LED, 2 TRIÂNGULOS



Potência	1,05W
Tensão	12V
Modos de iluminação	4
Comprimento do cabo	5m
Magnetizado	No
Temperatura de trabalho	-30~50°C
Número PIN	7
Peso	1,67Kg
Dimensões (CxLxA)	1100x140mm

54162

81,00€



KIT MAGNÉTICO COM 2 SINALIZADORES LED E 2 TRIÂNGULOS REFLECTORES



Tensão	12-24V
Modos de iluminação	4
Magnetizado	Si/Yes
Temperatura de trabalho	-30~50°C
Número PIN	7
Peso	1,50Kg
Dimensões (CxLxA)	118x58x93mm

51886

44,00€



KIT MAGNÉTICO COM 2 FAROLINS, 2 TRIÂNGULOS REFLECTORES



Potência	4,96W
Tensão	12V
Magnetizado	Si/Yes
Temperatura de trabalho	-30~50°C
Número PIN	7
Peso	1,30Kg
Dimensões (CxLxA)	104x97mm

52839

64,00€

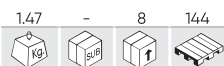

KIT MAGNÉTICO COM 2 FAROLINS, 2 TRIÂNGULOS REFLECTORES LED

Potência	1,05W
Tensão	12V
Magnetizado	Si/Yes
Temperatura de trabalho	-30~50°C
Número PIN	7
Peso	1,33Kg
Dimensões (CxLxA)	106x98mm



54078

68,00€

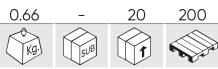

LUZ DE SEGURANÇA PARA EMPILHADEIRA



Potência	15W
Tensão	10-60V
Feixe de luz	Concentrada/Concentrated
Peso	0,66Kg
Dimensões (CxLxA)	150x95x115mm

51967

16,00€

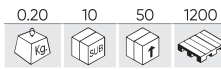

SIRENE REDONDA 12V-80V



Tensão	12-80V
Temperatura de trabalho	-30~70°C
Intensidade do som	97dB
Peso	0,20Kg
Dimensões (CxLxA)	113x50x80mm

51968

16,00€

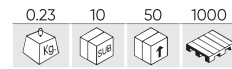

SIRENE QUADRADA 12V-80V



Tensão	12-80V
Temperatura de trabalho	-30~70°C
Intensidade do som	107dB
Peso	0,23Kg
Dimensões (CxLxA)	113x50x80mm

53536

34,00€

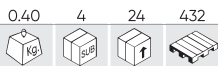

COMPROVADOR DE LUZES DE REBOQUE 7/13 PINOS



Tensão	9V
Contém	7-13Pins
Peso	0,40Kg
Dimensões (CxLxA)	270x65x56mm

51929

22,00€

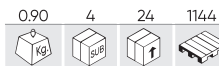

COMPROVADOR DE LUZES DE REBOQUE 7 PINOS



Tensão	9V
Contém	7Pins
Peso	0,90Kg
Dimensões (CxLxA)	195x50x40mm

PILHAS DE RECAMBIO

REF.	DESCRIÇÃO					€
51258	"AAA" RO3 1,5V	0.01	60	2400	134400	0,16€
10923	9V	0.05	10	500	-	1,10€



51258



10923

CARREGADOR DE ISQUEIRO E TOMADA CORRENTE

REF.					€
11107	0.06	-	250	-	4,90€
13839	0.04	-	200	-	10,90€
14031	0.10	10	100	1152	10,30€
14032	0.10	10	100	1200	13,50€
14033	0.10	10	100	500	4,50€
16052	0.05	10	100	-	3,40€
16053	0.05	10	100	-	4,50€



11107



13839



14031



14032



14033



16052 - 16053

FERRAMENTAS PNEUMÁTICAS

APARAFUSAR	174	OUTROS	193
PERFURAR	181	ENROLADORES DE MANGUEIRAS DE AR	195
LIXAR/POLIR	182	MANGUEIRAS CONECTORES	197
CORTAR / SERRAR	184	ACESSÓRIOS E CONSUMÍVEIS	198
PISTOLAS DE AR	187		
MANUTENÇÃO DE PNEUS	193		



54547

298,00€

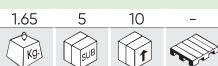

CHAVE DE IMPACTO 1/2" 2247NM



Medida do quadrado	1/2"
Entrada de ar	1/4"
Torque de aperto	1687Nm
Torque de desaperto	2247Nm
Velocidade nominal	8500RPM
Consumo real de ar	5,5CFM (158L/min)
Pressão do trabalho	6,2BAR
Intensidade do som	91,5dB
Sistema de martelo	Doble/Twin
Velocidades	4
Golpes por minuto	1650
Peso	1,65Kg
Dimensões (CxLxA)	180x190x70mm



REPOSIÇÕES DISPONÍVEIS

53689

238,00€

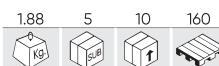

CHAVE DE IMPACTO 1/2" 1950NM



Medida do quadrado	1/2"
Entrada de ar	1/4"
Torque de aperto	1329Nm
Torque de desaperto	1950Nm
Velocidade nominal	8600RPM
Consumo real de ar	4CFM (113L/min)
Pressão do trabalho	6,3BAR
Intensidade do som	105dB
Sistema de martelo	Doble/Twin
Velocidades	5
Golpes por minuto	1400
Peso	1,88Kg
Dimensões (CxLxA)	250x264x102mm



REPOSIÇÕES DISPONÍVEIS

53520

228,00€

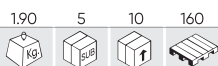

CHAVE DE IMPACTO 1/2" 1756NM



Medida do quadrado	1/2"
Entrada de ar	1/4"
Torque de aperto	1112Nm
Torque de desaperto	1756Nm
Velocidade nominal	7000RPM
Consumo real de ar	4,9CFM (139L/min)
Pressão do trabalho	6,2BAR
Intensidade do som	83dB
Sistema de martelo	Doble/Twin
Velocidades	3
Golpes por minuto	1200
Peso	1,90Kg
Dimensões (CxLxA)	206x193x70mm



REPOSIÇÕES DISPONÍVEIS

54521

129,00€



CHAVE DE IMPACTO 1/2" 1750 NM



Medida do quadrado	1/2"
Entrada de ar	1/4"
Torque de aperto	1560Nm
Torque de desaperto	1750Nm
Velocidade nominal	7000RPM
Consumo real de ar	6,71CFM (190L/min)
Pressão do trabalho	6,2BAR
Intensidade do som	107dB
Sistema de martelo	Doble/Twin
Velocidades	4
Golpes por minuto	1100
Peso	2,15Kg
Dimensões (CxLxA)	188x61x186mm



REPOSIÇÕES DISPONÍVEIS



JBM RECOMENDA O USO DE SEUS ÓLEOS LUBRIFICANTES PARA OTIMIZAR O DESEMPENHO E AMPLIAR A VIDA ÚTIL DA FERRAMENTA

- ✓ 14534 ÓLEO PARA FERRAMENTA PNEUMÁTICA - 600ML
- ✓ 14560 ÓLEO PARA FERRAMENTA PNEUMÁTICA - 100ML



53726 128,00€

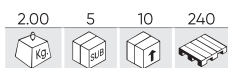

CHAVE DE IMPACTO 1/2" 1650NM



Medida do quadrado	1/2"
Entrada de ar	1/4"
Torque de aperto	1350Nm
Torque de desaperto	1650Nm
Velocidade nominal	7000RPM
Consumo real de ar	7CFM (198L/min)
Pressão do trabalho	6,2BAR
Intensidade do som	107dB
Sistema de martelo	Doble/Twin
Velocidades	3
Peso	2,00Kg
Dimensões (CxLxA)	1800x710x1840mm



REPOSIÇÕES DISPONÍVEIS

53588 178,00€



CHAVE DE IMPACTO MODELO MINI 1/2" 1302NM



Medida do quadrado	1/2"
Entrada de ar	1/4"
Torque de aperto	678Nm
Torque de desaperto	1302Nm
Velocidade nominal	10000RPM
Consumo real de ar	4CFM (113L/min)
Pressão do trabalho	6,2BAR
Intensidade do som	88,36dB
Sistema de martelo	Jumbo
Velocidades	6
Golpes por minuto	1600
Peso	1,44Kg
Dimensões (CxLxA)	173x120x60mm



REPOSIÇÕES DISPONÍVEIS

51206 228,00€



CHAVE DE IMPACTO 1/2" MINI 1302NM



Medida do quadrado	1/2"
Entrada de ar	1/4"
Torque de aperto	624Nm
Torque de desaperto	1302Nm
Velocidade nominal	11000RPM
Consumo real de ar	4,4CFM (125L/min)
Pressão do trabalho	6,2BAR
Intensidade do som	83dB
Sistema de martelo	Doble/Twin
Velocidades	3
Golpes por minuto	1600
Peso	1,20Kg
Dimensões (CxLxA)	192x153x56mm



REPOSIÇÕES DISPONÍVEIS

53608 98,00€

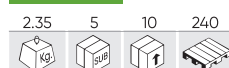

CHAVE DE IMPACTO 1/2" 1200NM



Medida do quadrado	1/2"
Entrada de ar	1/2"
Torque de aperto	880Nm
Torque de desaperto	1200Nm
Velocidade nominal	7500RPM
Consumo real de ar	6,5CFM (183,5L/min)
Pressão do trabalho	6,2BAR
Intensidade do som	107dB
Sistema de martelo	Doble/Twin
Velocidades	4
Peso	2,10Kg
Dimensões (CxLxA)	1870x705x1840mm



REPOSIÇÕES DISPONÍVEIS



ESTÃO DISPONÍVEIS PARA SI CONJUNTOS DE REPARAÇÃO PARA FERRAMENTAS PNEUMÁTICAS



Leia o código QR abaixo e escolha o conjunto que corresponde à sua ferramenta



54340

296,00€

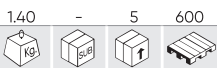

PISTOLA DE IMPACTO ARTICULADA DE 1/2" NANO 1/2" 813NM



REPOSIÇÕES DISPONÍVEIS

Medida do quadrado	1/2"
Entrada de ar	1/4"
Torque de aperto	610Nm
Torque de desaperto	813Nm
Velocidade nominal	8000RPM
Consumo real de ar	8CFM (226L/min)
Pressão do trabalho	6,2BAR
Intensidade do som	92dB
Sistema de martelo	Doble/Twin
Velocidades	3
Golpes por minuto	2000
Peso	1,40Kg
Dimensões (CxLxA)	88x60x311mm



54397

249,00€

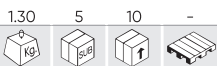

PISTOLA DE IMPACTO NANO-COMPACTA DE 1/2" 1004NM



REPOSIÇÕES DISPONÍVEIS

Medida do quadrado	1/2"
Entrada de ar	1/4"
Torque de aperto	500Nm
Torque de desaperto	1004Nm
Velocidade nominal	7500RPM
Consumo real de ar	3,4CFM (96L/min)
Pressão do trabalho	6,2BAR
Intensidade do som	92dB
Sistema de martelo	Doble/Twin
Velocidades	2
Golpes por minuto	1300
Peso	1,10Kg
Dimensões (CxLxA)	85x64x141mm

53733

238,00€

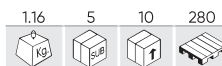

PISTOLA DE IMPACTO ANGULAR NANO DE 1/2" 350NM



REPOSIÇÕES DISPONÍVEIS

Medida do quadrado	1/2"
Entrada de ar	1/4"
Torque de aperto	231Nm
Torque de desaperto	350Nm
Velocidade nominal	8500RPM
Consumo real de ar	4CFM (113L/min)
Pressão do trabalho	6,2BAR
Intensidade do som	88dB
Sistema de martelo	Jumbo
Velocidades	4
Golpes por minuto	1300
Peso	1,16Kg
Dimensões (CxLxA)	237x88x60mm



JBM RECOMENDA O USO DE SEUS ÓLEOS LUBRIFICANTES PARA OTIMIZAR O DESEMPENHO E AMPLIAR A VIDA ÚTIL DA FERRAMENTA

- ✓ 14534 ÓLEO PARA FERRAMENTA PNEUMÁTICA - 600ML
- ✓ 14560 ÓLEO PARA FERRAMENTA PNEUMÁTICA - 100ML



51210

650,00€

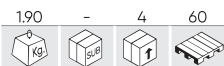

CHAVE DE IMPACTO DE 3/4" 2034NM + ALARGADOR 15CM



Medida do quadrado	3/4"
Entrada de ar	3/8"
Torque de aperto	1627Nm
Torque de desaperto	2034Nm
Velocidade nominal	5500RPM
Consumo real de ar	8CFM (226L/min)
Pressão do trabalho	6,2BAR
Intensidade do som	90dB
Sistema de martelo	Doble/Twin
Velocidades	6
Golpes por minuto	900
Peso	1,90Kg
Dimensões (CxLxA)	368x232x87mm



REPOSIÇÕES DISPONÍVEIS

51213

690,00€

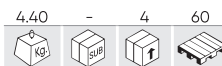

CHAVE DE IMPACTO 1" 2034NM + ALARGADOR 19CM



Medida do quadrado	1"
Entrada de ar	3/8"
Torque de aperto	1627Nm
Torque de desaperto	2034Nm
Velocidade nominal	5500RPM
Consumo real de ar	8CFM (226L/min)
Pressão do trabalho	6,2BAR
Intensidade do som	90dB
Sistema de martelo	Doble/Twin
Velocidades	6
Golpes por minuto	900
Peso	4,40Kg
Dimensões (CxLxA)	376x232x87mm



REPOSIÇÕES DISPONÍVEIS

51212

488,00€



CHAVE DE IMPACTO 3/4" 2034NM



Medida do quadrado	3/4"
Entrada de ar	3/4"
Torque de aperto	1627Nm
Torque de desaperto	2034Nm
Velocidade nominal	5500RPM
Consumo real de ar	8CFM (226L/min)
Pressão do trabalho	6,2BAR
Intensidade do som	90dB
Sistema de martelo	Doble/Twin
Velocidades	6
Golpes por minuto	900
Peso	3,40Kg
Dimensões (CxLxA)	232x215x87mm



REPOSIÇÕES DISPONÍVEIS

51211

560,00€



CHAVE DE IMPACTO 1" 2034NM



Medida do quadrado	1"
Entrada de ar	3/8"
Torque de aperto	1627Nm
Torque de desaperto	2034Nm
Velocidade nominal	5500RPM
Consumo real de ar	8CFM (226L/min)
Pressão do trabalho	6,2BAR
Intensidade do som	90dB
Sistema de martelo	Doble/Twin
Velocidades	6
Golpes por minuto	900
Peso	3,50Kg
Dimensões (CxLxA)	232x223x87mm



REPOSIÇÕES DISPONÍVEIS



DESCUBRA PASSO A PASSO COMO FAZER CORRETAMENTE A MANUTENÇÃO DA SUA FERRAMENTA PNEUMÁTICA



Leia o código QR abaixo para aceder à nossa página de tutoriais em vídeo



53681

743,00€

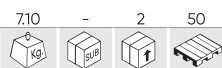

CHAVE DE IMPACTO PARA CAMINHÕES
ULTRA LIGEIRA 1" 2441NM



REPOSIÇÕES
DISPONÍVEIS



Medida do quadrado	1"
Entrada de ar	1/2"
Torque de aperto	1965Nm
Torque de desaperto	2441Nm
Velocidade nominal	6000RPM
Consumo real de ar	10CFM (282L/min)
Pressão do trabalho	6,2BAR
Intensidade do som	90dB
Sistema de martelo	Doble/Twin
Velocidades	3
Peso	7,10Kg
Dimensões (CxLxA)	522x175x143mm

52814

528,00€



CHAVE DE IMPACTO PARA CAMINHÕES 1"
3260NM



REPOSIÇÕES
DISPONÍVEIS



Medida do quadrado	1"
Entrada de ar	1/2"
Torque de aperto	3260Nm
Torque de desaperto	2180Nm
Velocidade nominal	3600RPM
Consumo real de ar	14,7CFM (424L/min)
Pressão do trabalho	6BAR
Intensidade do som	108dB
Sistema de martelo	Doble/Twin
Velocidades	6
Peso	18,50Kg
Dimensões (CxLxA)	650x180x150mm

53343

285,00€



CHAVE DE IMPACTO 3/4" 2200NM



Medida do quadrado	3/4"
Entrada de ar	3/8"
Torque de aperto	2200Nm
Torque de desaperto	1600Nm
Velocidade nominal	4600RPM
Consumo real de ar	9CFM (254L/min)
Pressão do trabalho	90PSI
Sistema de martelo	Doble/Twin
Velocidades	6
Peso	7,60Kg
Dimensões (CxLxA)	250x263x102mm

51222

128,00€



CHAVE DE IMPACTO DOBLE BLISTER 1/2"
101NM



REPOSIÇÕES
DISPONÍVEIS



Medida do quadrado	1/2"
Entrada de ar	1/4"
Torque de aperto	101Nm
Torque de desaperto	101Nm
Velocidade nominal	10000RPM
Consumo real de ar	3CFM (85L/min)
Pressão do trabalho	6,3BAR
Sistema de martelo	Único/Single
Velocidades	16
Golpes por minuto	1000
Peso	0,90Kg
Dimensões (CxLxA)	156x89x57mm



JBM RECOMENDA O USO DE SEUS ÓLEOS LUBRIFICANTES
PARA OTIMIZAR O DESEMPENHO E AMPLIAR A VIDA ÚTIL DA
FERRAMENTA

- ✓ 14534 ÓLEO PARA FERRAMENTA PNEUMÁTICA - 600ML
- ✓ 14560 ÓLEO PARA FERRAMENTA PNEUMÁTICA - 100ML



52156

141,00€

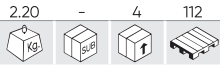

KIT DE 16 CHAVES COM PISTOLA E ROQUETE 1/2"



Medida do quadrado	1/2"
Entrada de ar	1/4"
Torque de aperto	312Nm
Torque de desaperto	61Nm
Velocidade nominal	7000RPM
Consumo real de ar	5CFM (142L/min)
Pressão do trabalho	6,2BAR
Intensidade do som	94dB
Sistema de martelo	Doble/Twin
Velocidades	1
Contém	Vasos/Sockets sets 9, 10, 11, 13, 14, 17, 19, 22, 24, 27mm
Peso	2,20Kg
Dimensões (CxLxA)	310x240x95mm

52165

126,00€

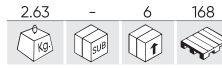

CHAVE DE IMPACTO DE 1/2" 680NM



Medida do quadrado	1/2"
Entrada de ar	1/4"
Torque de aperto	680Nm
Torque de desaperto	680Nm
Velocidade nominal	7000RPM
Consumo real de ar	7CFM (198L/min)
Pressão do trabalho	6,2BAR
Intensidade do som	94dB
Sistema de martelo	Doble/Twin
Velocidades	5
Golpes por minuto	900
Peso	2,63Kg
Dimensões (CxLxA)	185,5x70x186,5mm

52331

201,00€

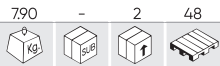

KIT FERRAMENTAS PNEUMÁTICA

x1 Pistola de impacto 1/2"	x5 Pedras de pulir 1/4"
x1 Martelo pneumático 150mm	x5 Pedras de pulir 3/8"
x1 Roquete pneumático 3/8"	x2 Cilindros de lizar (3/4" e 1")
x1 Amoladora pneumática	x1 Adaptador rápido fêmea
x1 Mola de retenção	x1 Conector de ponteiro
x1 Barre de extensão 1/2" - 75mm	x8 Pontas de bufar
x1 Galheta de óleo mini	x1 Conector m-m conexão rápida
x1 Chave hex. 4mm	x2 Adaptadores 1/8" para lizas
x8 Chaves de impacto	x1 Conector rápido m-h
x1 Pistola de ar	x1 Boca de borracha
x1 Mini pistola de ar	x1 Boca cônica
x1 Rolo de teflón	x1 Agulha de ar
x4 Ponteiros 120mm	x1 Boca de alta pressão
x2 Chaves fixas manuais	x1 Boca de segurança
x5 Disco de lijado 1/4"	x1 Caixa de plástico
x5 Disco de lizar 1/2"	



ESTÃO DISPONÍVEIS PARA SI CONJUNTOS DE REPARAÇÃO PARA FERRAMENTAS PNEUMÁTICAS



Leia o código QR abaixo e escolha o conjunto que corresponde à sua ferramenta



54336

259,00€

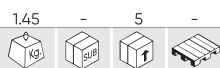

CATRACA ARTICULADA DE 1/2" 127NM



Medida do quadrado	1/2"
Entrada de ar	1/4"
Torque de aperto	95Nm
Torque de desaperto	127Nm
Velocidade nominal	150RPM
Consumo real de ar	79CFM (139L/Min)
Pressão do trabalho	6,2BAR
Intensidade do som	92dB
Peso	1,45Kg
Dimensões (CxLxA)	272x506x768mm



51214

148,00€

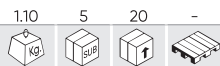

MINI ROQUETE 1/4" 40.7NM



Medida do quadrado	1/4"
Entrada de ar	1/4"
Torque de aperto	40,7Nm
Velocidade nominal	350RPM
Consumo real de ar	7,9CFM (138L/min)
Pressão do trabalho	6,2BAR
Intensidade do som	85dB
Peso	1,10Kg
Dimensões (CxLxA)	133x38x53mm



51215

119,00€

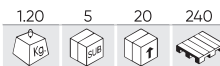

CATRACA DE 1/2" 68NM



Medida do quadrado	1/2"
Entrada de ar	1/4"
Torque de aperto	68Nm
Velocidade nominal	150RPM
Consumo real de ar	4CFM (113L/min)
Pressão do trabalho	6,2BAR
Intensidade do som	82,3dB
Peso	1,20Kg
Dimensões (CxLxA)	256x45x51mm



52167

48,00€

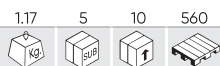

ROQUETE DE 1/2" 61NM



Medida do quadrado	1/2"
Entrada de ar	1/4"
Torque de aperto	61Nm
Velocidade nominal	150RPM
Consumo real de ar	4CFM (113L/min)
Pressão do trabalho	6,2BAR
Intensidade do som	95dB
Peso	1,17Kg
Dimensões (CxLxA)	263,5x56x41mm



53784

148,00€

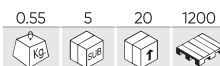

ROQUETE MINI DE 1/2" 40,7NM



Medida do quadrado	1/2"
Entrada de ar	1/4"
Torque de aperto	40,7Nm
Velocidade nominal	350RPM
Consumo real de ar	4CFM (113L/min)
Pressão do trabalho	6,2BAR
Intensidade do som	88dB
Peso	0,50Kg
Dimensões (CxLxA)	133x38x52mm



51221

199,00€

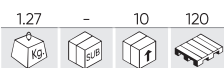

BROCA DE 3/8" EM ÂNGULO DE 90°



Medida do quadrado	3/8"
Entrada de ar	1/4"
Velocidade nominal	1400RPM
Consumo real de ar	4CFM (113L/min)
Pressão do trabalho	6,2BAR
Intensidade do som	85dB
Medidas da broca	Ø9,5mm
Peso	1,27Kg
Dimensões (CxLxA)	220x119x45mm



51220

240,00€

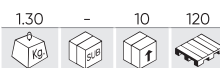

BROCA REVERSÍVEL 1/2"



Medida do quadrado	1/2"
Entrada de ar	1/4"
Velocidade nominal	800RPM
Consumo real de ar	4CFM (113L/min)
Pressão do trabalho	6,2BAR
Intensidade do som	83dB
Medidas da broca	Ø12,5mm
Peso	1,30Kg
Dimensões (CxLxA)	200x152x43mm



53573

36,00€

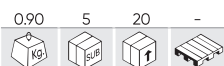

BERBEQUIM DIRETA

Medida do quadrado	3/8"
Entrada de ar	1/4"
Velocidade nominal	20000RPM
Consumo real de ar	4CFM (113L/min)
Pressão do trabalho	6,2BAR
Intensidade do som	89dB
Medidas da broca	Ø1,5-10mm
Peso	0,90Kg
Dimensões (CxLxA)	208,2x65,5x41,5mm



52159

64,00€

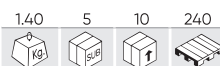

BERBEQUIM REVERSÍVEL DE 1/2"

Medida do quadrado	1/2"
Entrada de ar	1/4"
Velocidade nominal	700RPM
Consumo real de ar	4CFM (113L/min)
Pressão do trabalho	6,2BAR
Intensidade do som	86dB
Medidas da broca	Ø12,5mm
Peso	1,40Kg
Dimensões (CxLxA)	212,8x149,4x42mm



52527

82,00€

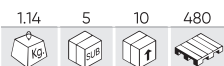

BERBEQUIM 3/8" ÂNGULO 90°

Medida do quadrado	3/8"
Entrada de ar	1/4"
Velocidade nominal	1500RPM
Consumo real de ar	4CFM (113L/min)
Pressão do trabalho	6,3BAR
Intensidade do som	86dB
Medidas da broca	Ø0,5-9,5mm
Peso	1,14Kg
Dimensões (CxLxA)	207,8x124,7x42,5mm



52160

48,00€

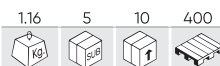

BERBEQUIM REVERSÍVEL DE 3/8"

Medida do quadrado	3/8"
Entrada de ar	1/4"
Velocidade nominal	1800RPM
Consumo real de ar	4CFM (113L/min)
Pressão do trabalho	6,2BAR
Intensidade do som	86dB
Medidas da broca	Ø9,5mm
Peso	1,16Kg
Dimensões (CxLxA)	194,3x149,4x42mm



52724

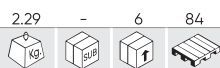

BERBEQUIM DE SOLDADURA COM DESVIO CENTRAL DA BROCA 1800RPM

Medida do quadrado	1/4"
Entrada de ar	1/4"
Velocidade nominal	1800RPM
Consumo real de ar	113L/min
Pressão do trabalho	6,2BAR
Intensidade do som	90dB
Medidas da broca	Ø8-6,5mm
Peso	2,29Kg
Dimensões (CxLxA)	280x60x265mm



381,00€



REPOSIÇÕES DISPONÍVEIS

52725

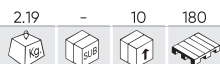

BERBEQUIM DE SOLDADURA COM DESVIO DO BERBEQUIM CENTRAL 1600RPM

Medida do quadrado	1/4"
Entrada de ar	1/4"
Velocidade nominal	1600RPM
Consumo real de ar	113L/min
Pressão do trabalho	6,2BAR
Intensidade do som	95,4dbA
Medidas da broca	Ø8-10mm
Peso	2,19Kg
Dimensões (CxLxA)	250x60x160mm



349,00€



REPOSIÇÕES DISPONÍVEIS

52157

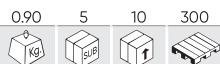

KIT DE 16 PEÇAS COM AMOLADORA 1/4"

Diâmetro da pinça	1/4", 1/8", 3, 6mm
Entrada de ar	1/4"
Velocidade nominal	25000RPM
Consumo real de ar	4CFM (113L/min)
Pressão do trabalho	6,2BAR
Intensidade do som	93dB
Diâmetro do eixo	1/4", 1/8"
Órbita de lixamento	x10
Ângulo	360°



48,00€

Peso	0,37Kg
Dimensões (CxLxA)	121x51x34mm

52171

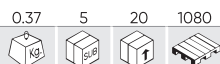

MINI AMOLADORA 1/4"

Diâmetro da pinça	1/4", 1/8", 3, 6mm
Entrada de ar	1/4"
Velocidade nominal	25000RPM
Consumo real de ar	4CFM (113L/min)
Pressão do trabalho	6,2BAR
Intensidade do som	93dB



39,00€

Diâmetro do eixo	1/4"
Peso	0,37Kg
Dimensões (CxLxA)	121x51x34mm

51245

99,00€

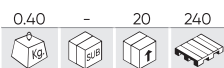

MINI AMOLADORA DE 3/8"

Tamanho do eixo	3/8"
Entrada de ar	1/4"
Velocidade nominal	25000RPM
Consumo real de ar	4CFM (113L/min)
Pressão do trabalho	6,3BAR
Intensidade do som	80,6dB
Peso	0,6Kg
Dimensões (CxLxA)	159x39x63mm



REPOSIÇÕES DISPONÍVEIS

51218

288,00€

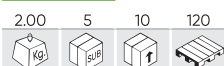

REBARBADORA ÂNGULAR 1/4"

Medida do quadrado	3/8"
Entrada de ar	1/4"
Velocidade nominal	12000RPM
Consumo real de ar	20,8CFM
Pressão do trabalho	6,2BAR
Intensidade do som	87,5dB
Diâmetro do eixo	0,6-8mm
Capacidade de corte	0,6-8mm



REPOSIÇÕES DISPONÍVEIS

Diâmetro do disco	5"
Peso	2,00Kg
Dimensões (CxLxA)	239x232x98mm

53137

38,00€

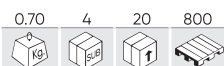

MINI AMOLADORA

Medida do quadrado	1/4"
Entrada de ar	1/4"
Velocidade nominal	25000RPM
Consumo real de ar	85L/min
Pressão do trabalho	6,2BAR
Intensidade do som	101dB
Diâmetro do disco	3-6mm



Peso	0,70Kg
Dimensões (CxLxA)	155x39x65mm

53141

73,00€

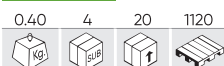

AMOLADORA PNEUMÁTICA

Medida do quadrado	1/4"
Entrada de ar	1/4"
Velocidade nominal	18000RPM
Consumo real de ar	3CFM (86L/min)
Pressão do trabalho	6,2BAR
Intensidade do som	99dB
Diâmetro do eixo	6mm



Peso	0,40Kg
Dimensões (CxLxA)	150x50x85mm

52528

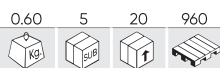

AMOLADORA ANGULAR 1/4"

Medida do quadrado	1/4"
Entrada de ar	1/4"
Velocidade nominal	20000RPM
Consumo real de ar	4CFM (113L/min)
Pressão do trabalho	6,2BAR
Intensidade do som	91dB
Diâmetro do eixo	1/4"

49,00€



Ângulo	90°
Peso	0,60Kg
Dimensões (CxLxA)	165x77x37mm

52953

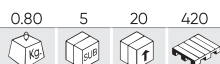

MOINHO DE 3" 18000RPM

Entrada de ar	1/4"
Velocidade nominal	18000RPM
Consumo real de ar	4CFM (113L/min)
Pressão do trabalho	6,2BAR
Intensidade do som	84dB
Diâmetro do disco	3"
Capacidade de corte	25mm

38,00€



REPOSIÇÕES DISPONÍVEIS

Peso	0,80Kg
Dimensões (CxLxA)	186x80,8x66,3mm

52574

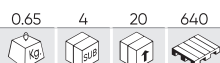

SERRA 1/4" 9000RPM

Entrada de ar	1/4"
Velocidade nominal	9000RPM
Consumo real de ar	6CFM (170L/min)
Pressão do trabalho	6,2BAR
Intensidade do som	89dB

69,00€



Capacidade de corte	1,6-2mm
Peso	0,65Kg
Dimensões (CxLxA)	236x71x40mm

52718



MARTILLO 9PCS

Medida do quadrado	1/2"
Entrada de ar	1/4"
Velocidade nominal	4500RPM
Consumo real de ar	4CFM (113L/min)
Pressão do trabalho	6,3BAR
Intensidade do som	103dB
Medidas da broca	Ø12,5mm
Golpes por minuto	4500

48,00€



Contém	Cincoes/Chisels
Peso	2,00Kg
Dimensões (CxLxA)	151x150x49mm

51216

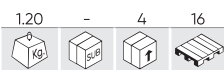

KIT PULIDORA

Entrada de ar	1/4"
Velocidade nominal	3500RPM
Consumo real de ar	10CFM (283L/min)
Pressão do trabalho	6,2BAR
Intensidade do som	83dB
Diâmetro do disco	11-23mm
Peso	1,20Kg
Dimensões (CxLxA)	272x70x203mm

650,00€



REPOSIÇÕES DISPONÍVEIS

53576

189,00€



3" CONJUNTO PARA A MINIMÁQUINA DE POLIMENTO



REPOSIÇÕES DISPONÍVEIS



Medida do quadrado	3"
Entrada de ar	1/4"
Velocidade nominal	2500RPM
Consumo real de ar	3,2CFM (91L/min)
Pressão do trabalho	6,2BAR
Intensidade do som	84dB
Diâmetro do disco	75mm
Peso	0,80Kg
Dimensões (CxLxA)	147x116x37mm

53646

69,00€



3" CONJUNTO PARA A MÁQUINA DE POLIMENTO



REPOSIÇÕES DISPONÍVEIS



Entrada de ar	1/4"
Velocidade nominal	3200RPM
Consumo real de ar	3,5CFM (99L/min)
Pressão do trabalho	6,2BAR
Intensidade do som	88dB
Diâmetro do eixo	16,8mm
Diâmetro do disco	3"
Peso	0,85Kg
Dimensões (CxLxA)	209,6x80x121,2mm

53626

18,00€

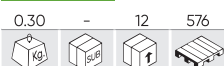

KIT DE RESTAURAÇÃO DE FARÓIS

CONTÉM

	x2	Ep800 discos de lixar
	x2	P1200 discos de lixar
	x2	P2000 discos de lixar
	x2	3.0ml liquido protetor uv
	x2	Adaptador (3/8" & 1/4")
	x1	85gm pasta de polimento
	x1	Fita adesiva
	x1	Disco de polimento de lã
	x1	Disco de esponja branco



EM EXPOSITOR DE 12 UDS



52676

99,00€

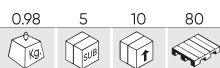

LIXADEIRA ORBITAL AUTO-ASPIRANTE

Entrada de ar	1/4"
Velocidade nominal	10500RPM
Consumo real de ar	3,5CFM (99L/min)
Pressão do trabalho	90PSI
Intensidade do som	6,2BAR
Diâmetro do disco	150mm
Órbita de lixamento	15 Agujeros/Holes
Órbita de lixamento	5mm



Ângulo	90°
Peso	0,98Kg
Dimensões (CxLxA)	223,3x147,5x105,9mm

52675

84,00€



LIXADEIRA ORBITAL ADAPTÁVEL ASPIRADOR 5MM

Entrada de ar	1/4"
Velocidade nominal	10500RPM
Consumo real de ar	3,5CFM (99L/min)
Pressão do trabalho	6,3BAR
Intensidade do som	90dB
Diâmetro do disco	150mm
Órbita de lixamento	15 Agujeros/Holes
Órbita de lixamento	5mm
Ângulo	90°
Peso	0,96Kg



52758

89,00€



PULIDORA

Entrada de ar	1/4"
Velocidade nominal	10500RPM
Consumo real de ar	3,5CFM (99L/min)
Pressão do trabalho	6,2BAR
Intensidade do som	90dB
Diâmetro do disco	150mm
Órbita de lixamento	15 Agujeros/Holes
Órbita de lixamento	2,5mm
Ângulo	90°
Peso	0,96Kg



54556

74,00€

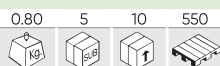

LIXADEIRA DE CINTA 3/8"

Medida do quadrado	3/8"
Entrada de ar	1/4"
Velocidade nominal	18000RPM
Consumo real de ar	113L/min
Pressão do trabalho	6,2BAR
Intensidade do som	89dB
Órbita de lixamento	10x330mm
Órbita de lixamento	60x80x120mm



REPOSIÇÕES DISPONÍVEIS

Ângulo	90°
Peso	0,80Kg
Dimensões (CxLxA)	290x100x50mm

50751

43,00€



BOMBA DE MASSA PNEUMÁTICA

Entrada de ar	1/4"
Capacidade	500ml
Pressão do trabalho	6,2BAR
Pressão máxima	30Mpa
Peso	1,50Kg



54255



CONJUNTO COMPLETO DE ACESSÓRIOS
PISTOLA DE LUBRIFICAÇÃO

Peças	7
Extensão de mangueira	300mm
Adaptadores	90-360°
Peso	1,60Kg
Dimensões (CxLxA)	260x170x60mm

68,00€



52490

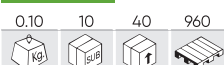

PISTOLA DE AR 100MM

6,65€



EM EXPOSITOR
DE 10 UDS



Entrada de ar	1/4"
Pressão do trabalho	8,2BAR
Comprimento	100mm
Peso	0,10Kg

52491

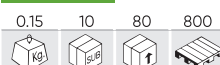

PISTOLA DE AR 300MM

10,50€



EM EXPOSITOR
DE 10 UDS



Entrada de ar	1/4"
Pressão do trabalho	8,3BAR
Comprimento	300mm
Peso	0,15Kg

53611



PISTOLA DE AR EXTRA-LONGA

27,50€

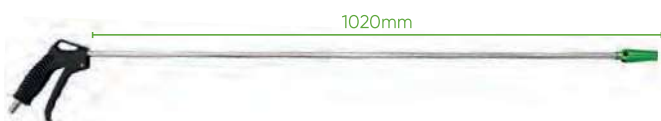

Entrada de ar	1/4"
Pressão do trabalho	11,7BAR
Comprimento	1020mm
Peso	0,50Kg

52798

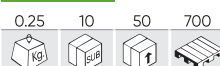

PISTOLA DE AR EXTENSÍVEL

18,00€



Entrada de ar	1/4"
Pressão do trabalho	11,7BAR
Comprimento	285-530mm
Peso	0,25Kg

54251

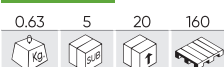

PISTOLA DE SOPRO E ASPIRAÇÃO

Entrada de ar	1/4"
Consumo real de ar	4,4CFM (96L/min)
Pressão do trabalho	6,2BAR
Diâmetro	3/8"-10mm
Comprimento	1450mm
Peso	0,63Kg

43,00€



VÍDEO
TUTORIAL

51980

15,00€

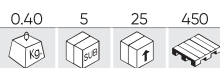

PISTOLA DE AR PARA PNEUMÁTICOS



Entrada de ar	1/4"
Pressão do trabalho	16BAR
Comprimento	330mm
Peso	0,40Kg

51981

23,50€

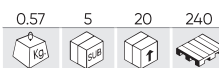

PISTOLA DE AR+PISTOLA PARA PNEUMÁTICOS



Entrada de ar	1/4"
Pressão do trabalho	12BAR
Comprimento	320mm
Peso	0,58Kg

51277

68,00€



KIT DE FERRAMENTAS PNEUMÁTICAS



PUNHO DE PISTOLA INFLADOR DE AR COM MEDIDOR	
Pressão de trabalho:	0-16BAR
Entrada de ar:	1/4"
Comprimento da mangueira:	330mm
PISTOLA DE AR COMPRIMIDO	
Pressão de trabalho:	0-12BAR
Entrada de ar:	1/4"
PISTOLA DE LAVAGEM DO MOTOR COM TANQUE PARA SOLUÇÃO DE LIMPEZA	
Máx. pressão:	10BAR
Entrada de ar:	1/4"
Capacidade:	600CC
Pot Material:	De aço
Material do corpo:	Liga de alumínio
Superfície:	Pó Revestido

SPIRAL HOSE	
Dimensão:	5x8mm
Comprimento máx. máximo:	4.5m
Entrada de ar:	1/4"
PISTOLA DE PINTURA POR GRAVIDADE COM TANQUE	
Consumo de ar:	0.3-0.5MPa
Diâmetro do bocal:	1.5mm
Capacidade do tanque:	600ml

52787

9,00€

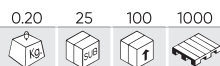

PISTOLA DE AR



Entrada de ar	1/4"
Pressão do trabalho	8,3BAR
Comprimento	260mm
Peso	0,20Kg

51383

11,60€

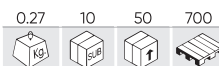

PISTOLA DE AR (EM BLISTER)



EM EXPOSITOR DE 10 UDS

Entrada de ar	1/4"
Pressão do trabalho	8BAR
Comprimento	150mm
Peso	0,27Kg

53205

22,50€

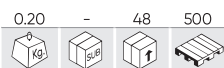

PISTOLA DE AR GRAN CAUDAL



Entrada de ar	1/4"
Pressão do trabalho	6,2BAR
Peso	0,19Kg
Dimensões (CxLxA)	160x30x100mm

52381

20,50€

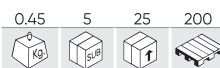

PISTOLA DE AR DE 3/8" COM MANGUEIRA DE 5M



Entrada de ar	3/8"
Pressão do trabalho	8,3BAR
Comprimento	5m
Peso	0,49Kg

54248

62,00€

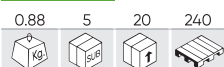

PISTOLA DE PINTURA



REPOSIÇÕES DISPONÍVEIS

Entrada de ar	1/4"
Consumo real de ar	10CFM (283L/min)
Pressão do trabalho	30BAR
Diâmetro	1,4-1,8mm
Peso	0,88Kg

54249

110,00€



PISTOLA DE PINTURA PROFISSIONAL



REPOSIÇÕES DISPONÍVEIS

Entrada de ar	1/4"
Consumo real de ar	10CFM (283L/min)
Pressão do trabalho	30BAR
Diâmetro	1,4mm
Peso	0,98Kg

53606

55,00€

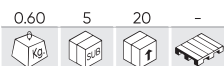

PISTOLA DE SECAGEM PNEUMÁTICA



Entrada de ar	1/4"
Taxa de fluxo de ar	Válvula reguladora/Regulating valve
Consumo real de ar	11,5CFM (325L/min)
Pressão do trabalho	4,1BAR
Comprimento	220mm
Peso	0,50Kg



53449

16,40€

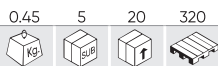

PISTOLA DE ENCHIMENTO ANALÓGICA



Entrada de ar	1/4"
Pressão do trabalho	0-6,9BAR
Comprimento	200mm
Peso	0,40Kg

53450

28,30€

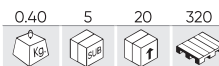

PISTOLA DE ENCHIMENTO DIGITAL



Entrada de ar	1/4"
Pressão do trabalho	0-13,8BAR
Comprimento	300mm
Peso	0,40Kg

MEDIDORES DE PRESSÃO

REF.	DESCRIÇÃO					€
52648	MEDIDOR DE PRESSÃO DOS PNEUS	0.08	5	100	2000	9,00€
53416	MEDIDOR DE PRESSÃO DE PNEUMÁTICOS COM TUBO (0-10BAR)	0.20	10	100	800	15,30€
53417	MEDIDOR DE PRESSÃO DE PNEUMÁTICOS DIGITAL COM TUBO (0-15BAR)	0.25	10	100	800	27,50€
53418	MEDIDOR DE PRESSÃO DE PNEUMÁTICOS DIGITAL (0-15BAR)	0.20	10	100	800	18,10€



52648



53416



53417



53418

51861

199,00€



MÁQUINA PNEUMÁTICA P/MONTAR FOLES DE TRANSMISSÕES



Entrada de ar	1/4"
Pressão do trabalho	9BAR
Material	Aluminio/Aluminum
Abertura	20-100mm
Peso	4,00Kg
Dimensões (CxLxA)	200x200x450mm

53625

68,00€

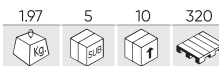

MARTELO DE AGULHAS PNEUMÁTICO



Entrada de ar	1/4"
Faixa	6,2BAR
Abertura	350mm
Peso	1,97Kg
Dimensões (CxLxA)	260x185x57mm

53542

980,00€

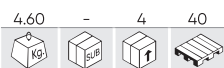

DESTANOLADOR PNEUMÁTICO DE PNEUS



REPOSIÇÕES DISPONÍVEIS

52540

221,00€

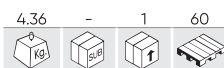

VENTOSA PNEUMÁTICA COM MARTELO DESLIZANTE



90003

35,20€

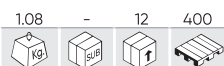

LÍQUIDO DESCARBONIZANTE



90004

25,80€

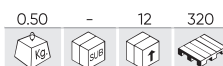

LÍQUIDO NEUTRALIZANTE



52543

182,00€

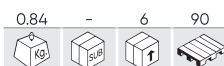

PISTOLA LIMPIADORA DE FILTROS DE PARTÍCULAS



53593

41,00€



PISTOLA DE JACTO DE AREIA PNEUMÁTICA



REPOSIÇÕES DISPONÍVEIS

53204

81,00€



PISTOLA DE LIMPEZA TORNADO



Entrada de ar	1/4"
Faixa	8BAR
Consumo real de ar	6,5CFM (184L/min)
Peso	0,65Kg
Dimensões (CxLxA)	238x110x160mm

Entrada de ar	1/4"
Faixa	9,1BAR
Consumo real de ar	8-10CFM (227-283L/min)
Peso	0,66Kg
Dimensões (CxLxA)	325x120x235mm

52575

119,00€

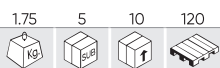

REBITADOR PNEUMÁTICO



Entrada de ar	1/4"
Adaptadores	3/16", 5/32", 1/8", 3/32"
Consumo real de ar	0,03CFM (0,86L/min)
Tração	720,00Kg
Binário máximo	23-69Nm
Peso	1,75Kg
Dimensões (CxLxA)	85x175x280mm

53202

15,70€

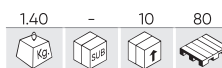

PISTOLA DE PETROLEADO



Entrada de ar	1/4"
Pressão do trabalho	10BAR
Peso	1,40Kg
Dimensões (CxLxA)	205x110x375mm

53567

43,00€

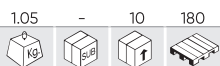

PISTOLA DE SILICONE PNEUMÁTICA 310ML



Entrada de ar	1/4"
Pressão do trabalho	2,5-5BAR
Capacidade	310ml
Peso	1,05Kg
Dimensões (CxLxA)	305x185x65mm

52533

10,00€

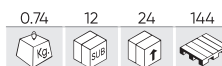

PISTOLA SILICONE 300ML



Capacidade	300ml
Peso	0,74Kg
Dimensões (CxLxA)	360x215x60mm

53572

348,00€



FERRAMENTA PNEUMÁTICA PARA POLIMENTO DE VÁLVULAS - PERCUSSÃO E ROTAÇÃO

Peças	12
RPM (rotações por minuto)	800
Entrada de ar	1/4"
Consumo real de ar	1,80CFM (51L/min)
Peso	1,90Kg
Dimensões (CxLxA)	283x87x70mm



REPOSIÇÕES DISPONÍVEIS



54555 **149,00€**

4.00 - 1 24

BOMBA DE TRANSMISSÃO PNEUMÁTICA 10L

Capacidade	10L
Pressão do trabalho	2,8-11,7BAR
Entrada de ar	1/4"
Temperatura de trabalho	-3/140°C
Peso	4,00Kg
Dimensões (CxLxA)	280x245x530mm

54514 **109,00€**

3.50 - 4 32

BOMBA PNEUMÁTICA/MANUAL PARA EXTRAÇÃO DE ÓLEO 6.5L

Capacidade	6,5L
Pressão do trabalho	2,76-11,72BAR
Entrada de ar	1/4"
Temperatura de trabalho	2/80°C
Peso	3,15Kg
Dimensões (CxLxA)	225x215x565mm

14534 **18,80€**

0.55 6 12 540

ÓLEO PARA FERRAMENTA PNEUMÁTICA - 600ML

Capacidade	600ml
Viscosidade	12,1/40°C
Densidade relativa a 15°C	0,845

14560 **8,80€**

0.10 12 72 1008

ÓLEO PARA FERRAMENTA PNEUMÁTICA - 100ML

EM EXPOSITOR DE 12 UDS

Capacidade	100ml
Viscosidade	12,1/40°C
Densidade relativa a 15°C	0,845

FILTRO E REGULADOR DE AR

REF.	"					€
53063	1/4"	0.63	5	50	300	37,00€
53064	3/8"	0.63	5	50	300	37,40€
53065	1/2"	0.60	5	50	300	39,00€



FILTRO, REGULADOR DE AR E LUBRIFICADOR

REF.	"					€
53066	1/4"	1.08	5	25	250	61,00€
53067	3/8"	1.08	5	25	250	61,00€
53068	1/2"	1.00	5	25	250	63,00€





DISCOS DE CORTE

REF.	DESCRIÇÃO					€
51385	DISCO CORTE DE 4"X1/32"	0.01	10	300	800	4,95€
51387	DISCO DE CORTE DE 3"	0.03	10	300	800	3,65€

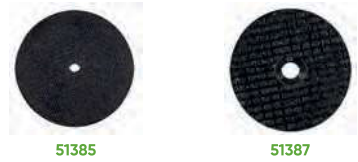

DISCOS LIXA

REF.	DESCRIÇÃO					€
51386	DISCO LIXA DE 5"	0.10	-	25	800	6,60€
51443	DISCO DE LIXA #60	0.50	25	150	800	6,20€
51444	DISCO DE LIXA #80	0.02	-	25	800	5,70€
51445	DISCO DE LIXA #120	0.02	-	25	800	5,70€



DISCO PARA LIXADEIRAS

REF.	DESCRIÇÃO					€
13499	DISCO DE 15 BURACOS PARA LIXADEIRAS	0.10	-	50	1500	12,50€
13500	DISCO DE 66 BURACOS PARA LIXADORAS	0.65	5	50	-	12,90€
12009	DISCO DE 6 BURACOS PARA LIXADEIRAS	0.14	-	50	-	11,00€



52378 10,00€

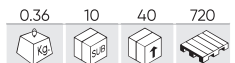

GANCHO MAGNÉTICO



51341 37,00€



COLGADOR IMANTADO PARA FERRAMENTA PNEUM



53492

380,00€

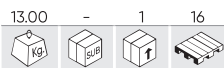

EXPOSITOR DE FERRAMENTA PNEUMÁTICA



EXPOSITOR SEM FERRAMENTAS



53147

41,00€

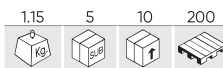

EXPOSITOR DE FERRAMENTA PNEUMÁTICA



53594

54,00€

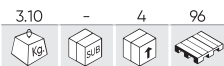

MANGUEIRA DE AR 8MM - 25M



REPOSIÇÕES DISPONÍVEIS



Pressão do trabalho	20,7BAR
pressão de ruptura	95,5BAR
Diâmetro interior	8mm
Diâmetro exterior	13mm
Comprimento	25M
Temperatura de trabalho	-40/65°C
Compatível com	52736
Peso	3,10Kg

53595

61,00€



MANGUEIRA DE AR 10MM - 25M



REPOSIÇÕES DISPONÍVEIS



Pressão do trabalho	20,1BAR
pressão de ruptura	65,5BAR
Diâmetro interior	10mm
Diâmetro exterior	15mm
Comprimento	25M
Temperatura de trabalho	-40/65°C
Compatível com	52737
Peso	3,20Kg

MANGUEIRA ESPIRAL PNEUMÁTICA

REF.	m	8mm	5mm	"	0.55	-	6	348	€
53629	10m	8mm	5mm	1/4"	0.55	-	6	348	14,90€
53630	15m	8mm	5mm	1/4"	0.65	-	6	240	21,00€
53631	15m	12mm	8mm	1/4"	1.25	-	6	144	35,50€
53632	15m	15mm	10mm	1/4"	2.20	-	6	78	49,50€
53633	15m	15mm	10mm	3/8"	2.10	-	6	78	49,50€
53634	15m	18mm	13mm	1/2"	2.60	-	6	66	69,00€

Com extremidades giratórias de 360 graus para facilitar o movimento e a facilidade de uso

- Material da mangueira: PU.
- Superfície roscada: latão.



CARRETEL DE MANGUEIRA DE AR BOCA



COM REPARTIDOR



SUPORTE DE PAREDE INCLUÍDO

14772 **8,90€**

0.35	-	20	-

REF. 53582 / REF. 53583



SUPORTE DE PAREDE INCLUÍDO

14771 **12,10€**

0.35	-	30	-

REF. 53532 / REF. 53581

20+2m

REF.		m	"					€
53582		22m	3/8"	10.40	-	1	14	174,00€
53583		22m	3/8"	10.75	-	1	14	174,00€

12+1m

REF.		m	"					€
53532		13m	3/8"	6.60	-	2	30	119,00€
53581		13m	3/8"	6.70	-	2	30	119,00€

10+1,5m

REF.		m	"					€
53881		11m	1/4"	4.50	-	4	48	79,00€
53882		11m	1/4"	4.50	-	4	48	79,00€



CARRETEL DE MANGUEIRA PARA ÓLEO BOCA DE 1/2" 15M

REF.		m	"	PSI	BAR					€
50797		16m	1/2"	2450PSI	169BAR	26.60	-	1	14	490,00€



CONECTOR DE MANGUEIRA

REF.	DESCRIÇÃO					€
14204	EUR - M6 M 1/4"	0.06	50	200	-	1,50€
14205	EUR - M8 M 3/8"	0.06	50	200	-	1,50€
14206	EUR - M10 M 1/2"	0.05	50	200	-	1,50€
14207	US - M6 M 1/4"	0.05	50	200	-	1,50€
14208	US - M8 M 3/8"	0.06	50	200	-	1,50€
14209	US - M10 M 1/2"	0.05	50	200	-	1,50€



CONECTOR UNIVERSAL DE SEGURANÇA PARA MANGUEIRA

REF.	DESCRIÇÃO					€
14201	M6	0.10	25	100	-	4,30€
14202	M8	0.10	25	100	-	4,35€
14203	M10	0.10	25	100	-	4,85€



CONECTOR / ROSCA

REF.	PCS	"	US					€
13930	1	1/4"	♂	♂	0.01	50	100	1,55€
13932	1	3/8"	♂	♂	0.07	50	100	2,50€
14076	1	3/8"	♂	♀	0.10	50	100	1,70€
13933	1	1/2"	♂	♂	0.06	50	100	2,00€
13935	2	1/4"	♀	♀	0.05	50	100	2,50€
13936	1	1/4"	♀	♀	0.10	50	100	4,15€
13937	1	1/4"	♀	♂	0.07	50	100	4,20€
14078	1	3/8"	♀	♀	0.10	50	100	4,45€
14191	1	1/2"	♂	♀	0.04	50	100	2,00€
14193	1	1/2"	♀	♀	0.10	50	100	4,50€

REF.	PCS	"	EUR					€
13931	2	1/4"	♂	♂	0.02	50	100	2,50€
14075	1	3/8"	♂	♀	0.10	50	100	2,00€
13934	2	1/4"	♂	♀	0.02	50	100	2,50€
13938	1	1/4"	♀	♀	0.10	50	200	4,05€
13939	1	1/4"	♀	♂	0.07	50	100	4,05€
14077	1	3/8"	♀	♀	0.10	50	100	4,50€
14190	1	1/2"	♂	♀	0.04	50	100	2,00€
14192	1	1/2"	♀	♀	0.10	50	100	4,45€



CONECTOR DE SEGURANÇA UNIVERSAL

REF.	"	[♀]	[♂]	[0.05]	[25]	[100]	[4000]	€
14195	1/4"	♀	♂	0.20	25	100	-	4,30€
14196	3/8"	♀	♂	0.10	25	100	-	4,30€
14197	1/2"	♀	♂	0.10	25	100	-	4,50€
14198	1/4"	♀	♀	0.10	25	100	-	4,05€
14199	3/8"	♀	♀	0.10	25	100	-	4,00€
14200	1/2"	♀	♀	0.10	25	100	-	4,85€



CONECTOR ARTICULADO MACHO PARA AR COMPRIMIDO EURO

REF.	DESCRIÇÃO	[0.05]	[25]	[100]	[4000]	€
14314	EUR - 1/4"	0.05	25	100	-	5,20€
14315	US - 1/4"	0.06	25	100	-	5,60€



14561

[0.05]	[25]	[50]	[-]
[Kg]	[25]	[50]	[-]

CONECTOR LUBRIFICANTE 1/4"



8,80€

ENGATE RÁPIDO PNEUMÁTICO

REF.	DESCRIÇÃO	[0.05]	[25]	[100]	[4000]	€
52735	ENGATE RÁPIDO PNEUMÁTICO M6	0.05	25	200	4000	5,20€
52736	ENGATE RÁPIDO PNEUMÁTICO M8	0.10	25	200	4000	5,70€
52737	ENGATE RÁPIDO PNEUMÁTICO M10	0.10	25	200	4000	5,90€



ADAPTADOR ARTICULADO

REF.	DESCRIÇÃO	[0.15]	[62]	[125]	[-]	€
12988	ADAPTADOR ARTICULADO PNEUMÁTICO DE 1/2"	0.15	62	125	-	12,00€
13809	ADAPTADOR ARTICULADO 1/4"	0.10	62	248	-	18,50€
13810	ADAPTADOR ARTICULADO 3/8"	0.10	62	250	-	20,50€



FERRAMENTAS DE IMPACTO

CHAVES DE CAIXA DE IMPACTO

200

PEÇAS SOBRESSALENTES

207

ESPECIAL PNEUS

203

ESPECIAL CAMINHÕES

208

ADAPTADORES

206



52694

49,50€

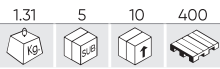

KIT DE 3 CHAVES XZN DE 1/2" DE IMPACTO



		1/2"	x3	78mmL	30, 32, 36mm
--	--	------	----	-------	--------------

52337

69,00€

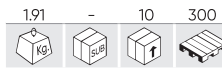

KIT DE 6 CHAVES DE IMPACTO DE 1/2"



		1/2"	x3	80mmL	30, 32, 36mm
		1/2"	x3	43mmL	14, 17, 19mm

52547

96,00€



KIT DE 8 CHAVES E PUNTAS XZN DE IMPACTO DE 1/2"



REPOSIÇÕES DISPONÍVEIS



		1/2"	x5	78mmL	27, 30, 32, 34, 36mm
		1/2"	x3	43mmL	M14, M15, M18

52345

109,00€

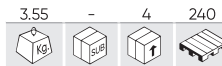

KIT DE 19 CHAVES DE IMPACTO DE 1/2" HEX + ADAPTADOR



REPOSIÇÕES DISPONÍVEIS



		1/2"	x14	78mmL	10, 11, 12, 13, 14, 15, 16, 17, 18, 19, 21, 22, 24, 27mm
		1/2"	x3	50, 150, 250mm	
		1/2"	x1	ADAPTADOR DE IMPACTO 1/2" F 3/4" M	
		1/2"	x1	ARTICULAÇÃO UNIVERSAL DE IMPACTO DE 1/2"	

53531

111,00€

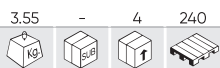

SET 19 PEÇAS DE IMPACTO DE 1/2" COM 14 VASOS DE 12 CANTOS + ADAPTADORES



REPOSIÇÕES DISPONÍVEIS



		1/2"	x14	78mmL	10, 11, 12, 13, 14, 15, 16, 17, 18, 19, 21, 22, 24, 27mm
		1/2"	x3	50, 150, 250mm	
		1/2"	x1	ADAPTADOR DE IMPACTO 1/2" F 3/4" M	
		1/2"	x1	ARTICULAÇÃO UNIVERSAL DE IMPACTO DE 1/2"	

52341

59,00€

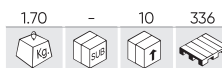

KIT DE 13 CHAVES DE IMPACTO DE 1/2" HEX. + ADAPTADOR



REPOSIÇÕES DISPONÍVEIS



		1/2"	x10	38mmL	10, 11, 12, 13, 14, 17, 19, 21, 22, 24mm
		1/2"	x1	125mm	
		1/2"	x1	AUMENTO DE IMPACTO DE 125MM 1/2"	
		1/2"	x1	ARTICULAÇÃO UNIVERSAL DE IMPACTO DE 1/2"	

52346 103,00€

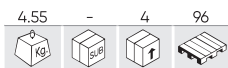

KIT DE 12 CHAVES DE IMPACTO COMPRIDOS DE 1/2"



REPOSIÇÕES DISPONÍVEIS



		1/2"	x12	78mmL	10, 12, 13, 15, 16, 17, 18, 19, 21, 22, 24, 27mm
		1/2"	x2	125, 250mm	
		1/2"	x1	ARTICULAÇÃO UNIVERSAL DE IMPACTO DE 1/2"	

53060 34,90€

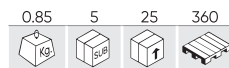

JOGO DE 12 CHAVES DE IMPACTO 1/2" HEX. PERFIL BAIXO



		1/2"	x12	10, 11, 12, 13, 14, 15, 16, 17, 18, 19, 20, 21mm
--	--	------	-----	--

52342 63,00€

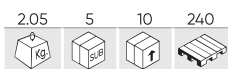

KIT DE 11 CHAVES DE IMPACTO HEX. DE 1/2"



REPOSIÇÕES DISPONÍVEIS



		1/2"	x11	78mmL	10, 11, 12, 13, 14, 16, 17, 19, 21, 22, 24mm
--	--	------	-----	-------	--

53744 63,00€

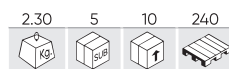

KIT DE 11 PCS. CABEÇA ALTA DE CHOQUE DE 12 LADOS 1/2"



REPOSIÇÕES DISPONÍVEIS



		1/2"	x11	78mmL	10, 11, 12, 13, 14, 16, 17, 19, 21, 22, 24mm
--	--	------	-----	-------	--

52810 9,00€

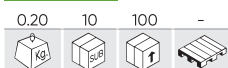

CHAVE DE IMPACTO XZN INVIOVÁVEL M16

- Soquetes de impacto de 75mm de comprimento quadrados de 1/2" para extrair o parafuso de drenagem com chave de impacto em transmissões de VAG, Porsche, Ford, etc.



		1/2"	x1	75mm	M16
--	--	------	----	------	-----

52811 9,90€



CHAVE DE IMPACTO XZN INVIOVÁVEL M18

- Para extrair o braço de direção do veiculos do grupo VAG.



		1/2"	x1	75mm	M18
--	--	------	----	------	-----

52546

40,50€

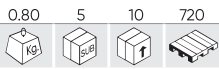

KIT DE 6 CHAVES E PUNTAS XZN DE IMPACTO DE 1/2"



REPOSIÇÕES DISPONÍVEIS



		1/2"	x3	43mmL	M14, M16, M18
		1/2"	x3	78mmL	M14, M16, M18

52344

197,00€

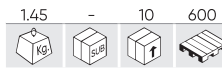

KIT DE 13 CHAVES DE IMPACTO DE 1/2" HEX E TORX



		1/2"	x5	45mmL	5, 6, 8, 10, 12mm
		1/2"	x8	45mmL	T30, T40, T45, T50, T55, T60, T70, T80

52339

61,00€

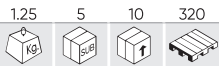

KIT DE 8 CHAVES DE IMPACTO HEX. DE 1/2"



REPOSIÇÕES DISPONÍVEIS



		1/2"	x9	78mmL	5, 6, 7, 8, 10, 12, 14, 17, 19mm
--	--	------	----	-------	----------------------------------

52340

58,00€

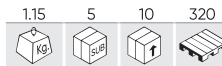

KIT DE 9 CHAVES DE IMPACTO TORX DE 1/2" T60



REPOSIÇÕES DISPONÍVEIS



		1/2"	x9	78mmL	T20, T25, T30, T40, T45, T50, T55, T60, T70
--	--	------	----	-------	---

53470

176,00€

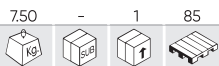

KIT DE 8 CHAVES DE IMPACTO LARGAS HEX. DE 3/4"



		3/4"	x8	90mmL	24, 27, 29, 30, 32, 34, 36, 38mm
--	--	------	----	-------	----------------------------------

52347

158,00€



KIT DE 8 CHAVES DE IMPACTO HEX. 3/4"



		3/4"	x8	90mmL	26, 27, 29, 30, 32, 35, 36, 38mm
--	--	------	----	-------	----------------------------------

51028 163,00€

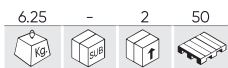

KIT DE 16 CHAVES DE IMPACTO



REPOSIÇÕES DISPONÍVEIS



	3/4"	x4	H17, H19, H22, H24		1"	x1	22mm
	3/4"	x5	T60, T70, T80, T90, T100		3/4"	x1	22mm
	3/4"	x4	E18, E20, E22, E24			x1	4mm

52969 22,50€

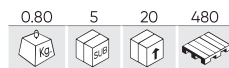

KIT DE 3 CHAVES DE IMPACTO HEX. LONGO



REPOSIÇÕES DISPONÍVEIS



	1/2"	x3	78mmL	17, 19, 21mm
--	-------------	----	-------	--------------

54316 182,00€

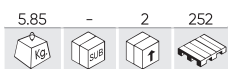

CONJUNTO DE 8 CHAVES DE IMPACTO LONGAS 1"



REPOSIÇÕES DISPONÍVEIS



	1"	x6	90mmL	24, 27, 30, 32, 33, 36mm
	1"	x2	95mmL	38, 41mm

52348 179,00€

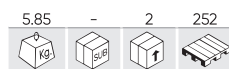

KIT DE 8 CHAVES DE IMPACTO DE 1"



REPOSIÇÕES DISPONÍVEIS



	1"	x2	58mmL	24, 27mm
	1"	x3	62mmL	30, 32, 33mm
	1"	x2	65mmL	36, 38mm
	1"	x1	68mmL	41mm

54548 198,00€

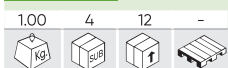

CONJUNTO DE 3 CHAVES DE IMPACTO DE BINÁRIO LIMITADO



REPOSIÇÕES DISPONÍVEIS



	1/2"	x1		101mmL	17mm
	1/2"	x1		101mmL	19mm
	1/2"	x1		101mmL	21mm

53587 44,00€



CONJUNTO DE 4 CHAVES DE CAIXA DE IMPACTO PARA RODAS DE LIGA LEVE - 1/2"



REPOSIÇÕES DISPONÍVEIS



	1/2"	x1		85mmL	15mm	Smart
	1/2"	x1		85mmL	17mm	Mercedes
	1/2"	x1		85mmL	21mm	Hyundai / Kia
	1/2"	x1		85mmL	22mm	Opel

53988

101,00€

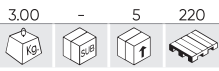

KIT DE 10 CHAVES DE IMPACTO DE 1/2"

	1/2"	x1		85mmL	15mm	
	1/2"	x1		85mmL	17mm	
	1/2"	x1		85mmL	19mm	
	1/2"	x1		85mmL	21mm	
	1/2"	x1		85mmL	22mm	
	1/2"	x1		85mmL	23mm	
	1/2"	x1		85mmL	24mm	
	1/2"	x1		85mmL	17mm	Mercedes
	1/2"	x1		85mmL	21mm	Hyundai/Kia
	7/8"	x1		85mmL		Tesla



52338

29,00€

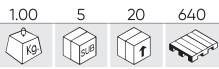

KIT DE 4 CHAVES IMPACTO DE 1/2" PARA RODAS

	1/2"	x1		85mmL	17mm	
	1/2"	x1		85mmL	19mm	
	1/2"	x1		85mmL	21mm	
	1/2"	x1		85mmL	22mm	



REPOSIÇÕES DISPONÍVEIS

51336

19,90€

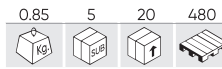

KIT DE 3 CHAVES DE IMPACTO DE 1/2"

	1/2"	x1		85mmL	17mm	
	1/2"	x1		85mmL	19mm	
	1/2"	x1		85mmL	21mm	



REPOSIÇÕES DISPONÍVEIS

52343

52,00€

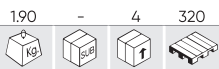

KIT DE 12 CHAVES DE IMPACTO DE 1/2" HEX. - ESPECIAL EXTRAÇÃO RODAS

	1/2"	x1		85mmL	17mm	
	1/2"	x1		85mmL	19mm	
	1/2"	x1		85mmL	21mm	
	1/2"	x1		42mmL	27mm	
	1/2"	x8		38mmL	10, 11, 13, 14, 17, 19, 22, 24mm	



54734

19,00€

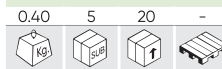

CONJUNTO DE 2 CHAVES DE IMPACTO 1/2" PARA RODAS DE ALUMÍNIO FORD

	1/2"	x1		18,5x19,5mm	FORD
	1/2"	x1		20,5x21,5mm	FORD



53197

46,00€

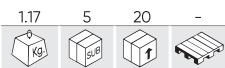

KIT DE 4 CHAVES DE IMPACTO PARA PARAFUSOS DE SEGURIDADE



		1/2"	x4	82mmL	17, 19, 21, 22mm
--	--	------	----	-------	------------------



53077

66,00€

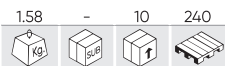

KIT DE BARRAS DE EXTENSÃO DE IMPACTO



REPOSIÇÕES DISPONÍVEIS

	1/2"	x1		100Nm
	1/2"	x1		110Nm
	1/2"	x1		200mm 120Nm
	1/2"	x1		135Nm
	1/2"	x1		150Nm



VOCÊ PODE GOSTAR...

REF.	"	Nm						€
13680	1/2"	200Nm		0.36	-	50	-	15,50€
13681	1/2"	190Nm		0.35	-	50	-	15,50€
13682	1/2"	175Nm		0.32	-	50	-	15,50€
13683	1/2"	160Nm		0.30	-	50	-	15,50€
13689	1/2"	90Nm		0.20	5	50	1500	15,50€



AUMENTO DE IMPACTO

REF.	"	mm					€
12937	1/2"	50mm	0.11	10	100	1500	9,50€
12074	1/2"	125mm	0.23	10	60	-	11,50€
12075	1/2"	250mm	0.45	10	100	-	15,50€



ARTICULAÇÃO UNIVERSAL DE IMPACTO

REF.	"						€
11938	3/4"	0.62	10	50	-		47,00€
11990	1/2"	0.15	10	100	-		15,30€



53043

0.43	5	50	1000

KIT DE 3 ARTICULAÇÕES DE IMPACTO COM DUPLA POSIÇÃO (FIXO / ARTICULADO)

57,00€



x3 1/4", 1/2", 3/4"

53044

129,00€

2.43	-	8	1000

KIT DE 8 CHAVES DE IMPACTO HEX. COM DUPLA POSIÇÃO (FIXO / ARTICULADO)



x8 1/2" 13, 14, 15, 16, 17, 19, 21, 22mm

52545

179,00€

3.00	-	4	1500

JOGO DE 2 ADAPTADORES DE IMPACTO



1"-1/2"H x 1"M

1"H x 1"-1/2"M

53743

39,70€

0.80	5	20	640

CONJUNTO DE 6 ADAPTADORES DE IMPACTO



REPOSIÇÕES DISPONÍVEIS



1/4"H - 3/8"M

3/8"H - 1/4"M

3/8"H - 1/2"M

1/2"H - 3/8"M

1/2"H - 3/4"M

3/4"H - 1/2"M

52544

94,00€

2.90	-	4	384

KIT DE 6 ADAPTADORES DE IMPACTO



REPOSIÇÕES DISPONÍVEIS



1/2"H - 3/4"M

1/2"H - 1"M

3/4"H - 1/2"M

3/4"H - 1"M

1"H - 1/2"M

1"H - 3/4"M



CHAVES DE IMPACTO ESPECIAIS

REF.	"						€	
14172		15	85	SMART	0.20	10	50	8,50€
14173	1/2"	17	85	MERCEDES	0.20	10	50	9,50€
14177	1/2"	22	85	OPEL	0.25	10	50	9,50€
14178	1/2"	21	85	KIA/HYUNDAI	0.25	10	50	9,50€

REF.	"						€
11314		17	85	0.22	10	100	8,50€
11315	1/2"	19	85	0.25	10	100	8,50€
11316	1/2"	21	85	0.26	10	100	8,50€
11628	1/2"	22	85	0.27	10	50	8,50€

REF.	"						€
16748		17	100	0.36	10	50	76,00€
16749	1/2"	19	100	0.36	10	50	76,00€
16750	1/2"	21	100	0.36	10	50	76,00€



CHAVES DE CAIXA DE IMPACTO

1"

REF.						€
11153	36	65	0.70	6	18	23,40€
11154	37	65	0.73	6	24	24,00€
11155	38	65	0.90	6	12	24,40€
11156	39	65	0.74	6	24	25,50€
11157	40	70	0.78	6	12	26,60€
11158	41	70	0.95	6	18	28,50€
11159	42	70	1.00	6	18	30,30€
11160	43	70	0.95	6	12	31,20€
11161	44	70	0.90	6	18	32,30€
11162	45	70	1.10	4	8	33,10€
11163	46	70	1.00	4	12	34,00€
11164	47	70	1.05	4	8	34,90€
11165	48	70	1.00	4	8	35,70€
11166	50	75	1.21	4	12	36,20€
11167	51	75	1.18	4	8	38,00€
11168	52	85	1.18	-	10	39,20€
11169	53	85	1.27	4	12	40,00€
11170	54	85	1.33	4	12	41,00€
11171	55	85	1.44	2	8	43,00€
11172	56	85	1.47	4	8	46,00€
11173	57	85	1.44	4	8	47,00€

REF.						€
11174	58	85	1.58	4	8	48,00€
11175	59	85	1.58	4	120	49,00€
11176	60	90	1.75	2	4	53,00€
11177	62	90	1.63	2	4	55,00€
11178	63	90	1.75	-	8	56,00€
11179	65	90	1.87	2	8	59,00€
11180	67	90	1.93	2	8	65,00€
11181	68	90	1.93	2	8	67,00€
11182	70	95	2.05	2	4	70,00€
11183	71	95	3.10	-	6	73,00€
11184	73	95	3.27	-	4	87,00€
11185	75	95	3.34	-	6	91,00€
11186	76	95	3.35	-	5	97,00€
11187	78	95	3.47	-	5	98,00€
11188	80	95	3.60	-	4	103,00€
11189	85	100	3.80	-	4	121,00€
11190	89	100	3.80	-	2	138,00€
11191	90	100	3.90	-	4	149,00€
11192	92	105	4.85	-	2	152,00€
11193	95	105	4.90	-	2	183,00€
11194	100	105	4.43	-	4	190,00€

REF.						€
11621	105	155	8.50	-	2	290,00€
11622	110	155	8.13	-	2	399,00€
11623	115	155	8.62	-	2	489,00€

EXTRA LONGO

REF.						€
13745	28	90	0.77	6	24	25,20€
13746	30	90	0.95	6	12	25,40€
13747	32	90	0.92	6	12	25,40€
13748	33	90	0.88	2	16	26,00€



3/4"

REF.						€
11126	19	51	0.25	-	10	11,20€
11127	21	51	0.30	6	24	13,80€
11128	22	51	0.35	10	40	14,10€
11129	24	51	0.32	6	54	14,50€
11130	25	54	0.45	6	24	14,90€
11131	26	54	0.32	6	36	15,10€
11132	27	54	0.30	6	54	15,40€
11133	28	54	0.40	6	12	15,80€
11134	30	54	0.41	6	24	16,20€
11135	32	56	0.45	4	48	16,80€
11136	33	56	0.50	6	12	17,50€
11137	34	56	0.50	6	24	18,20€
11138	35	56	0.50	6	12	18,50€
11139	36	56	0.50	4	24	18,80€

REF.						€
11140	38	57	0.55	6	24	19,50€
11141	40	57	0.55	6	12	20,70€
11142	41	57	0.60	6	12	21,30€
11143	46	63	0.75	6	18	26,40€
11144	50	68	1.00	6	24	33,30€
11145	51	70	1.10	4	12	35,30€
11146	55	73	1.27	2	16	37,30€
11147	57	73	1.25	4	12	41,00€
11148	60	75	1.40	4	12	47,00€
11149	63	76	1.32	4	12	48,00€
11150	65	78	1.35	-	8	55,00€
11151	67	80	1.49	4	12	57,00€
11152	70	80	1.49	4	12	59,00€

LONGO

REF.						€
13723	19	90	0.43	2	12	18,50€
13724	21	90	0.50	6	12	18,70€
13725	22	90	0.61	6	18	19,00€
13726	24	90	0.56	6	24	19,20€
13727	26	90	0.51	6	18	19,50€
13728	27	90	0.50	6	18	20,00€
13729	29	90	0.70	6	12	21,00€
13730	30	90	0.70	2	24	21,60€
13731	32	90	0.71	2	24	22,00€
13732	33	90	0.75	6	24	23,80€
13733	34	90	0.85	6	18	24,90€
13734	35	90	0.80	6	18	25,70€
13735	36	90	0.81	6	12	25,80€
13736	38	90	0.83	6	18	25,90€

1/2"

LONGO

REF.	1	2	3	4	5	€
12061	10	78	0.14	10	100	8,00€
14736	11	78	0.15	5	20	8,00€
12062	12	78	0.15	10	100	8,00€
12063	13	78	0.15	10	50	9,00€
14737	14	78	0.15	5	20	9,00€
12064	15	78	0.17	10	100	9,00€
12065	16	78	0.30	10	20	9,50€
12066	17	78	0.20	10	100	9,50€
12067	18	78	0.22	10	20	9,50€
12068	19	78	0.21	10	50	10,00€
12069	21	78	0.25	10	50	10,00€
12070	22	78	0.27	10	100	10,50€
12071	24	78	0.30	10	50	11,00€
12072	27	78	0.36	5	60	12,00€

CURTO

REF.	1	2	3	4	5	€
14728	10	38	0.10	5	20	3,80€
14729	11	38	0.05	10	100	3,80€
14730	12	38	0.05	10	100	3,80€
14731	13	38	0.10	5	20	3,80€
14732	14	38	0.10	5	20	3,80€
11195	17	38	0.10	10	100	4,00€
11121	19	38	0.10	10	100	4,10€
14733	21	38	0.10	5	20	4,30€
14734	22	38	0.15	5	20	5,40€
11122	24	38	0.14	10	20	5,45€
11123	27	38	0.20	10	50	6,50€
11124	30	38	0.20	10	50	7,65€
11125	32	38	0.23	10	50	8,50€

1/2"

CURTO

REF.	1	2	3	4	5	€
16569	36	42	0.47	10	40	21,00€
16570	27	42	0.35	10	40	21,00€

LONGO

REF.	1	2	3	4	5	€
14738	10	78	0.15	10	100	5,50€
14739	11	78	0.15	10	100	5,50€
14740	12	78	0.16	10	100	5,55€
14741	13	78	0.15	10	100	5,55€
14742	14	78	0.15	10	100	5,55€
14743	16	78	0.14	10	100	5,60€

REF.	1	2	3	4	5	€
14744	17	78	0.18	10	50	5,80€
14745	19	78	0.22	10	50	6,25€
14746	21	78	0.24	10	50	6,40€
14747	22	78	0.27	10	50	7,10€
14748	24	78	0.30	10	50	8,30€
11613	27	78	0.35	10	20	11,00€
11614	30	78	0.40	10	50	13,00€
11615	32	78	0.45	6	24	14,20€
11616	33	78	0.44	6	12	18,10€
11617	34	78	0.42	6	24	18,70€
11618	35	78	0.48	6	18	18,80€
11619	36	78	0.47	4	48	19,50€

52834

195,00€

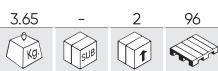

CAIXA COM CHAVES COM DENTES EXTERIORES



x11 22x3.3, 26x3.8, 30x4.3, 33x4.0, 37x4.8, 44x5.3, 50x5.8, 56x5.8, 63x6.3, 69x6.8, 75x6.8mm

52835

272,00€



KIT CHAVES COM DENTES INTERIORES



x10 26.0x22.0x2.8x2.5, 31.0x23.5x2.8x3.0, 34.0x26.5x3.8x2.5, 38.0x29.5x4.8x2.5, 42.0x34.5x3.8x3.5, 50.0x40.5x4.8x3.5, 58.0x46.5x4.8x4.0, 75.0x59.5x5.8x4.5, 82.0x65.8x5.8x5.0, 88.0x71.8x5.6x5.0mm

52914 223,00€

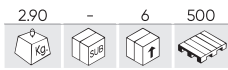

CHAVE DE EXTRAÇÃO DE CASTILHO BPW 120MM DR.41MM



120mm
8 CANTOS
CUADRADO HEXAGONAL 41mm

52915 199,00€



CHAVE DE EXTRAÇÃO DE CASTILHO BPW 111MM DR.41MM



111mm
OVAL
CUADRADO HEXAGONAL 41mm

52916 218,00€

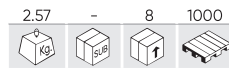

CHAVE DE EXTRAÇÃO DE CASTILHO BPW 109MM DR.41MM



109mm
8 CANTOS
CUADRADO HEXAGONAL 41mm

52917 122,00€

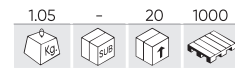

CHAVE DE EXTRAÇÃO DE CASTILHO BPW 65MM



65mm
OVAL
DIAGONAL 36MM

52918 146,00€

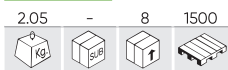

CHAVE HUBCAPS EIXO TRASEIRO BPW 95MM



95mm
CUADRADO 3/4"

52919 181,00€



CHAVE NUT RODA BPW 110MM 3/4"



110mm
8 CANTOS
CUADRADO 3/4"

52920 155,00€

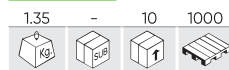

CHAVE EXTRAÇÃO ROLAMENTIOS EIXO BPW 80MM 3/4"



80mm
CUADRADO 3/4"

52921 117,00€



CHAVE EXTRAÇÃO NUT EIXO TRASEIRO BPW 65MM 3/4"



65mm
CUADRADO 3/4"

52922 180,00€

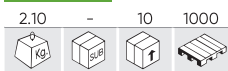

CHAVE EXTRAÇÃO PORCA ROLAMENTOS EIXOS BPW 85MM 3/4"



85mm
6 CANTOS
CUADRADO 3/4"

52923 59,00€



CHAVE EXTRAÇÃO NUT SUSPENSÃO SCANIA 28X37MM 3/4"



28x37mm
CUADRADO 3/4"

52924 52,00€



CHAVE EXTRAÇÃO EIXO SUSPENSÃO SCANIA 34X46MM 3/4"



34x46mm
CUADRADO 3/4"

52925 176,00€

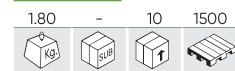

CHAVE RODA DIANTEIRA SCANIA 80MM H41



80mm
8 CANTOS
CUADRADO HEXAGONAL 41mm

52926 201,00€



CHAVE EXTRAÇÃO RODA NUT SCANIA 100MM 3/4" 8 CANTOS



100mm
8 CANTOS
CUADRADO 3/4"

52927 59,00€



CHAVE AMORTECEDOR TRASEIRO SCANIA 34X56MM 3/4"



34x56mm
CUADRADO 3/4"

52928 172,00€



CHAVE RODA DIANTEIRA SCANIA 80MM 3/4" 8 CANTOS



80mm
8 CANTOS
CUADRADO 3/4"

52929 185,00€



CHAVE DE PORCA DE RODA SCANIA 95MM 3/4" 8 CANTOS



95mm
8 CANTOS
CUADRADO 3/4"

52930 117,00€

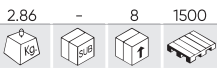

INSTALADOR PARA VIRABREGUIM TRASEIRO RETENTOR ÓLEO SCANIA



SCANIA 310/320
RETENTOR 0366303-R

52931 45,00€

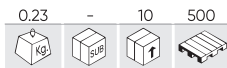

CHAVE CAMINHÃO SCANIA ROTAÇÃO EIXO DE COMANDO 1/2"



CUADRADO 1/2"

52932 45,00€

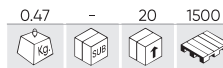

CHAVE PARA VÁLVULA DE INJEÇÃO ELECTROMAGNÉTICA SCANIA 38MM 1/2"



Ø38mm
CUADRADO 1/2"

52933 194,00€

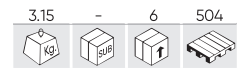

CHAVE 8 ALMENAS SCANIA 420



Ø116mm - Ø100mm
8 ALMENAS
CUADRADO 3/4"
SCANIA 420

53430 286,00€



CHAVE DE BUCHA PARA IVECO



Ø134mm - Ø110,5mm
118x134mm
IVECO
12 FACES

52935 94,00€



CHAVE DE PORCA DE CAMINHÃO BENZ/MAN 60MM



60mm
CUADRADO 3/4"

52936 199,00€

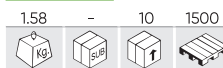

CHAVE EIXO TRASEIRO CAMINHÃO BENZ/MAN 80-95MM



80-95mm
CUADRADO 3/4"
6 ALMENAS

52937 265,00€



CHAVE EXTRAÇÃO HUB TRASEIRO CAMIÓN BENZ / MAN 95-115MM



95-115mm
CUADRADO 3/4"
6 ALMENAS

52938 199,00€



CHAVE EXTRAÇÃO EIXO DIREÇÃO BENZ / MAN



100mm
CUADRADO 3/4"
6 ALMENAS

52939 28,00€

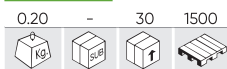

CHAVE PARA EXTRAÇÃO DE VÁLVULA DE INJEÇÃO DIESEL BENZ/MAN



22-28mm
CUADRADO 1/2"
4 ALMENAS

52940 235,00€



CHAVE PARA NUT DIFERENCIAL TRASEIRO BENZ/MAN



101mm
CUADRADO 3/4"
6 ALMENAS

52941 70,00€



CHAVE ROTAÇÃO VOLANTE DO MOTOR BENZ E MAN 2 ENGRENAGENS



CUADRADO 1/2"

52942 105,00€



CHAVE ROTAÇÃO VOLANTE BENZ Y MAN 3 ENGRENAGENS



CUADRADO 1/2"

52943 75,00€



CHAVE ROTAÇÃO VOLANTE DE MOTOR MAN



CUADRADO 1/2"

52934 102,00€



CHAVE PORCA HUB PARAFUSOS CAMINHÃO BENZ/MAN 56MM



56mm
CUADRADO 3/4"

REF.	mm			€
52944	30	1.00	20	110,00€
52945	39	2.74	24	281,00€

EXTRACTOR DE CABEÇA DE CAMINHÃO



52944
CUADRADO HEXAGONAL
30mm



52945
CUADRADO HEXAGONAL
39mm

CARROÇARIA

FERRAMENTAS PARA CARROÇARIA

212

RESTAURAÇÃO DE FARÓIS

217

SUBSTITUIÇÃO DE VIDRO

218

REPARAÇÃO DO CHASSIS

220

MOBÍLIA AUXILIAR

222

MANUTENÇÃO INTERIOR

225



53224

142,00€



KIT REPARADOR DE AMOLGADELAS

- x5 SACO DE 5 DISCOS AZUIS PARA REF. 53224
- x5 SACO DE 4 DISCOS AMARELOS PARA REF. 53224
- x10 SACO DE 10 DISCOS VERMELHOS PARA REF. 53224
- x5 SACO DE 5 BARRAS DE COLA PARA REF. 53224



REPOSIÇÕES DISPONÍVEIS

52876

182,00€

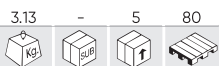

KIT ENCONTRADORES PARA CHAPEIROS 7 PCS

- x1 ENCONTRADOR TIPO BIGORNA
- x1 ENCONTRADOR TIPO TRILHO
- x1 ENCONTRADOR TIPO DUPLA FACE
- x1 ENCONTRADOR TIPO PUNHO COM CABEÇA CONVEXA
- x1 ENCONTRADOR TIPO VIRGULA
- x1 ENCONTRADOR TIPO CALCANHAR
- x1 ENCONTRADOR TIPO VIRGULA CON MANGO



REPOSIÇÕES DISPONÍVEIS

51131

61,00€

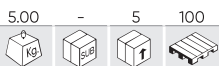

KIT ENCONTRADORES E MARTELOS PARA CHAPEIROS

- x1 MARTELO BOCA PLANA
- x1 MARTELO BOCA PLANA/PEÑA
- x1 MARTELO BOCA PLANA CÔNICA
- x1 ENCONTRADOR TIPO CALCANHAR
- x1 ENCONTRADOR TIPO CARRIL
- x1 ENCONTRADOR DUPLA EXTREMIDADE
- x1 ENCONTRADOR TIPO VIRGULA



REPOSIÇÕES DISPONÍVEIS

53545

38,50€

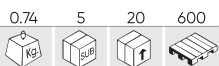

CAIXA DE 5 CHAVES DE CABEÇAS HEXAGONAIS ALONGADAS 3/8"

- | | | |
|----|------|-------------|
| x1 | | 8mm |
| x1 | | 10mm |
| x1 | 3/8" | 120mmL 12mm |
| x1 | | 13mm |
| x1 | | 14mm |



51832 18,00€

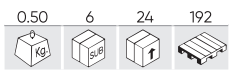

JOGO DE 4 ALAVANCAS DE NYLON TIPO FACA



x4 19x273, 22x273, 25x273, 36x273

50903 30,80€

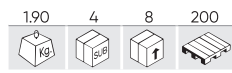

JOGO DE 5 ALAVANCAS DE FERRO

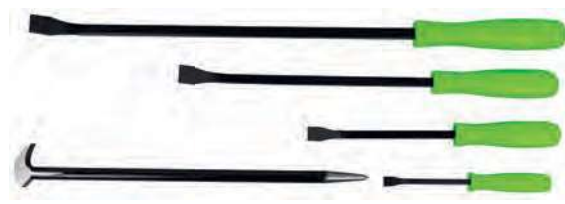

x5 180, 280, 380, 430, 600mm

52026 34,50€

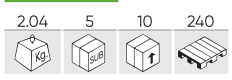

JOGO DE 2 ALAVANCAS DE FERRO

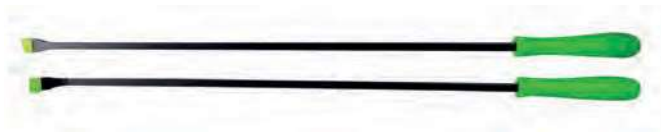

x2 900mm

51360 8,20€

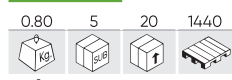

PÉ DE CABRA



x1 18" x 5/8 x1 24" x 3/4

51361 11,90€

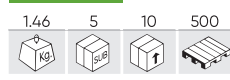

52851 9,65€

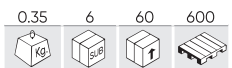

JOGO DE 2 ALAVANCAS PARA EXTRAÇÃO DE GRAMPOS



x2 7x220, 8.5x245mm

53110 29,50€

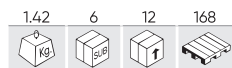

KIT DE 6 ALAVANCAS



x6 4.5x240, 8.5x240, 10.3x240, 4.5x490, 8.5x490, 10.3x490

50901 16,00€

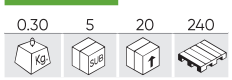

JOGO DE 5 ALAVANCAS DE NYLON

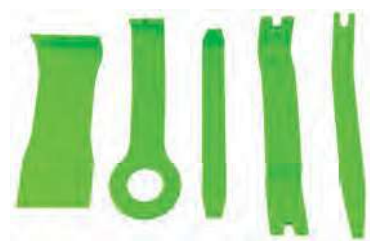

x5 60x160, 63x175, 30x200, 20x180, 20x215mm

52788 39,00€

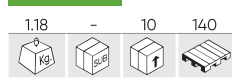

KIT DE 27 ALAVANCAS DE NYLON



52977

141,00€

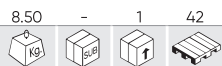

KIT DE 4 ALAVANCAS EXTRALARGAS



Peças	4
Medidas	0° 900x16mm, 30°900x16mm, 75°600x16mm, 90°600x16mm
Peso	8,50Kg
Dimensões (CxLxA)	1005x260x80mm

52540

221,00€



VENTOSA PNEUMÁTICA COM MARTELO DESLIZANTE



Peças	5
Resistência	7,6BAR
Diâmetro	75, 100, 125mm
Comprimento	620mm
Peso	4,36Kg
Dimensões (CxLxA)	620x250x100mm

54017

12,00€

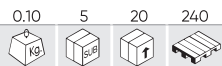

FERRAMENTA DE VEDAÇÃO DE SILICONE

Contém	Almohadillas de silicona/Silicone pads
Peso	0,10Kg
Dimensões (CxLxA)	270x44x95mm

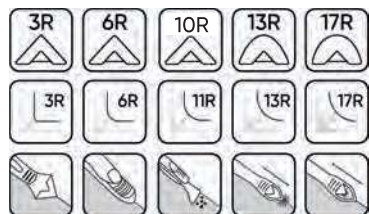

52533

10,00€

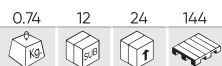

PISTOLA SILICONE 300ML



Capacidade	300ml
Peso	0,74Kg
Dimensões (CxLxA)	360x215x60mm

53567

43,00€



PISTOLA DE SILICONE PNEUMÁTICA 310ML



Entrada de ar	1/4"
Pressão do trabalho	2,5-5BAR
Capacidade	310ml
Peso	1,05Kg
Dimensões (CxLxA)	305x185x65mm

60032

123,00€



PISTOLA PARA SILICONE A BATERIA

Tensão	20V
Força máxima de empurrão	2500N
Velocidade de avanço	0,5-8 mm/s (30-480mm/min)
Capacidade do cartucho	300ml
Velocidade	Ajustable/Adjustable
Compatível com	60012, 60013, 60015, 60016, 60017
Peso	1,60Kg
Dimensões (CxLxA)	420x70x270mm

REPOSIÇÕES
DISPONÍVEIS

60032C

266,00€

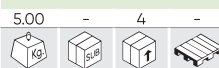
PISTOLA PARA SILICONE A BATERIA COM
CAIXA

Tensão	20V
Força máxima de empurrão	2500N
Velocidade de avanço	0,5-8mm/s (30-480mm/min)
Capacidade do cartucho	300ml
Velocidade	Ajustable/Adjustable
Inclui	60032, 60013, 60016
Compatível com	60012, 60013, 60015, 60016, 60017
Peso	4,96Kg
Dimensões (CxLxA)	500x130x400mm

REPOSIÇÕES
DISPONÍVEIS

PÁGINA 138

PILHAS E CARREGADORES NÃO INCLUÍDOS NAS
FERRAMENTAS INDIVIDUALESTrês tipos de bateria e dois tipos de carregador.
Escolha o que você preferir!

53525

12,00€

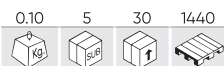
GRAMPO PARA ABRIDORES DO CAPÔ E
PORTA-MALAS

Diâmetro	10mm
Peso	0,10Kg
Dimensões (CxLxA)	140x90x30mm

53655

12,00€

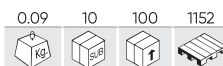

CHAVE PARA MAÇANETAS VAG



Marcas	VAG
Peso	0,09Kg
Dimensões (CxLxA)	340x70x40mm

54246

104,00€

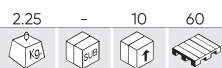

BALANÇA DE PRECISÃO DE 5KG



Capacidade	5Kg
Precisão	0,1g
Medição de voltagem em corrente alternada (AC)	220V
Medição de voltagem em corrente contínua (DC)	6V
Temperatura de trabalho	0-40°C
Umidade relativa	10%<RH<85%
Peso	2,25Kg
Dimensões (CxLxA)	280x115x285mm

54247

99,00€



BALANÇA DE PRECISÃO DE 2KG



Capacidade	2Kg
Precisão	0,1g
Medição de voltagem em corrente alternada (AC)	220V
Medição de voltagem em corrente contínua (DC)	6V
Temperatura de trabalho	0-40°C
Umidade relativa	10%<RH<85%
Peso	2,25Kg
Dimensões (CxLxA)	352x136x240mm

53230

20,50€

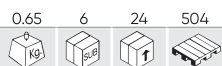

JOGO DE UTENSÍLIOS PARA ABRIR CARROS

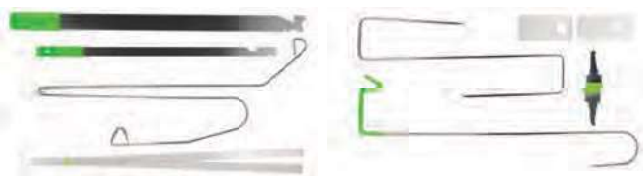

- x2 Fita de abertura de puxadores
- x2 Cunha de nylon com furo central
- x1 Gancho rígido em forma de "s"
- x1 Gancho deslizante para desbloqueio de seguros
- x1 Alavanca de desbloqueio larga 610mm
- x1 Alavanca de bloqueio estreito 558mm
- x1 Chave de encaixe para fechaduras
- x1 Gancho especial

52077

29,50€



JOGO DE 4 ALMOFADAS INFLÁVEIS



- x1 Almofada de 16x16cm
- x1 Almofada de 32x12cm
- x1 Almofada de 19x6cm
- x1 Almofada de 18x4,5cm
- x1 Bomba manual

53486

30,50€

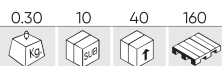

ECRÃ PARA INSPEÇÃO DE AMOLGADELAS



Diâmetro	800mm
Peso	0,30Kg
Dimensões (CxLxA)	320x300x40mm

15375

28,00€

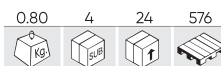

GARRAFA COM LÍQUIDO PARA REF. 53673



Capacidade	600ml
Peso	0,80Kg
Dimensões (CxLxA)	75x75x190mm

53673

80,00€

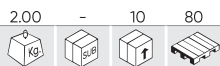

KIT DE RESTAURAÇÃO DE FARÓIS

x6	KIT DE 6 PAPÉIS ABRASIVOS PARA REF. 53673
x1	ADAPTADOR AC-DC PARA REF. 53673
x1	ADAPTADOR 12V PARA REF. 53673
x1	COPO DE EVAPORAÇÃO PARA REF. 53673
x1	TAMPA CURVADA COM ANEL DE VEDAÇÃO DE BORRACHA PARA REF. 53673
x1	TAMPA PLANA COM ANEL DE VEDAÇÃO DE BORRACHA PARA REF. 53673
x1	FUNIL PARA REF. 53673
x1	PLACA DE MOAGEM PARA REF. 53673
x1	PAPEL TEXTURIZADO PARA REF. 53673
x1	GARRAFA COM LÍQUIDO PARA REF. 53673



CONJUNTO DE 10 ELEMENTOS DO PAPEL ABRASIVO

REF.	GRÃO	kg	10	100	€
14710	180	0.25	10	100	3,90€
14711	280	0.20	10	100	3,90€
14712	360	0.20	10	100	4,00€

REF.	GRÃO	kg	10	100	€
14713	600	0.15	10	100	4,25€
14714	800	0.15	10	100	4,50€
14715	1200	0.10	10	100	4,75€



VÍDEO TUTORIAL



REPOSIÇÕES DISPONÍVEIS

52740

690,00€



ALINHADOR DE FARÓIS COM LUXÓMETRO 152CM



Altura mínima de elevação	230mm
Altura máxima de elevação	1350mm
Medição	LUX Digital
Compatível com	Hálogeno/Xenón
Peso	24,00Kg
Dimensões (CxLxA)	520x280x1520mm

52836

1.100,00€



ALINHADOR DE FARÓIS COM DUPLO LASER E LUXÓMETRO



VÍDEO TUTORIAL



Altura mínima de elevação	230mm
Altura máxima de elevação	1350mm
Medição	Láser/Laser, LUX Digital
Compatível com	Cualquier tipo de faro/Any type of car lighthouse
Peso	24,85Kg
Dimensões (CxLxA)	520x270x1560mm

53626

18,00€

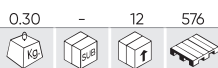

KIT DE RESTAURAÇÃO DE FARÓIS

- x2 EP800 Discos de lixar
- x2 P1200 Discos de lixar
- x2 P2000 Discos de lixar
- x2 3.0ml Líquido protetor UV
- x2 Adaptador (3/8" & 1/4")
- x1 85gm Pasta de polimento
- x1 Fita adesiva
- x1 Disco de polimento de lã
- x1 Disco de Esponja Branco



EM EXPOSITOR DE 12 UDS

53729

20,50€

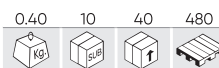

KIT DE FERRAMENTAS PARA AJUSTAR FARÓIS

	x1	H6
	x1	300mm H7
	x1	T25



VENTOSA

52262

7,50€

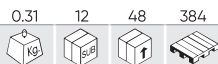

Peças	1
Diâmetro	115mm
Capacidade	40,00Kg

52263

13,50€

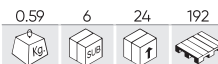

Peças	1
Diâmetro	115mm
Capacidade	70,00Kg

52264

21,50€

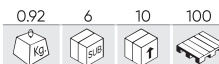

Peças	1
Diâmetro	115mm
Capacidade	100,00Kg

52265

30,50€

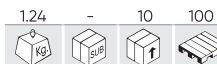

Peças	1
Diâmetro	115mm
Capacidade	120,00Kg

52295

6,50€

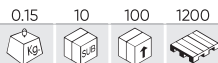

Peças	2
Diâmetro	60mm
Capacidade	5,00Kg

52589

13,00€



Peças	1
Diâmetro	70mm
Capacidade	8,00Kg

52765

21,70€

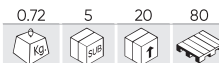

Peças	1
Diâmetro	120mm
Capacidade	80,00Kg

52998

48,00€



Peças	3
Diâmetro	120mm
Capacidade	80,00Kg

53232

39,50€

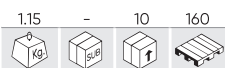

FERRAMENTAS PARA SUBSTITUIÇÃO DE PARA-BRISAS

x1	ÚTIL EXTRATOR DE MOLDURAS
x1	ALAVANCA PARA EXTRAIR A BORRACHA
x1	GANCHO EXTRATOR
x1	1.8M DE FIO DE CORTE
x2	CABOS PARA O FIO DE CORTE
x1	PASSA-CABOS



13813

7,00€

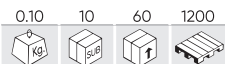

CABO PARA EXTRAÇÃO DE PÁRA-BRISAS

PARA REF. 53232



13814

11,00€

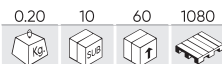

FERRAMENTA PARA EXTRAÇÃO DE PÁRA-BRISAS

PARA REF. 53232



52321

8,80€

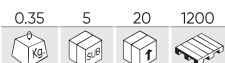

CINTA DE APERTO POLIÉSTER COM TENSOR 5M X 25MM



Peças	2
Comprimento	5m
Capacidade	800Kg
Peso	0,35Kg
Dimensões (CxLxA)	125x115x30mm

52327

12,00€

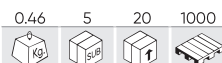

CINTA DE APERTO POLIÉSTER COM TENSOR 8M X 25MM



Peças	2
Comprimento	8m
Capacidade	800Kg
Peso	0,46Kg
Dimensões (CxLxA)	150x140x40mm

50577

12,60€

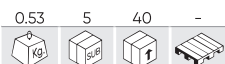

ALICATE DE PRESSÃO



Comprimento	280mm
Peso	0,53Kg

52386

25,50€

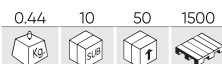

MORDAÇA DE PRESSÃO CURVADO - LISO



Comprimento	215mm
Peso	0,44Kg

52385

268,00€



JOGO DE 6 ALICATES DE MORDAÇA



52982

55,00€

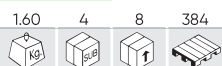

JOGO 3 MORDAÇAS DE PRESSÃO EXTRA-LARGAS



Ângulo	90°
Comprimento	340mm



Ângulo	45°
Comprimento	360mm



Ângulo	0°
Comprimento	370mm

53675

53,00€

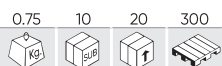

MORDAÇA DE PONTAS DIRETAS



EM EXPOSITOR DE 10 UDS

53676

47,00€

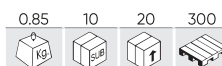

ALICATE DE PONTAS CURVAS



EM EXPOSITOR DE 10 UDS

53677

59,00€

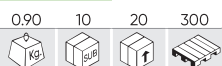

ALICATE DE PONTAS CURVAS E ALMOFADA GIRATÓRIA



EM EXPOSITOR DE 10 UDS

53678

55,00€







ALICATE DE PONTA CURVA LONGA



EM EXPOSITOR DE 10 UDS

MORDAÇAS

REF.	DESCRIÇÃO	mm	MATERIAL		T					€
52390	MORDAÇA ESPECIAL SOLDADURA	250mm	CrMo	-	-	0.50	5	40	640	37,50€
52474	MORDAÇA DE ARGOLA 5T	190mm	Aço	0-20mm	5T	3.49	-	5	1500	69,00€
52475	MORDAÇA PLANO 3T	170mm	Aço	0-25mm	3T	3.60	-	10	1500	62,00€
52476	MORDAÇA QUADRADO 5T	220mm	Aço	0-25mm	5T	3.10	-	10	1500	50,00€
52477	MORDAÇA DE MOLA 2T	200mm	Aço	0-60mm	2T	2.65	-	10	1500	70,00€
52478	MORDAÇA 90° 5T	170mm	Aço	0-20mm	5T	2.90	-	10	1500	49,00€
52479	MINI MORDAÇA PLANO 90° 3T	155mm	Aço	0-20mm	3T	1.18	-	30	1500	24,70€
52480	MINI MORDAÇA QUADRADA 90° 3T	210mm	Aço	0-25mm	3T	2.00	-	10	1500	44,00€
52481	MORDAÇA QUADRADA 3T	220mm	Aço	0-20mm	3T	2.05	-	10	1500	52,00€
52482	MORDAÇA PLANO ÂNGULO 45° 5T	210mm	Aço	0-10mm	5T	2.13	-	8	1500	44,00€
52483	MORDAÇA PLANO MINI 5T	210mm	Aço	0-10mm	5T	2.02	-	12	1500	41,00€
52484	UNIÃO DE CORRENTES 3T	280mm	Aço	0-110mm	3T	1.19	-	11	1500	70,00€
52485	UNIÃO DE GANCHOS DE 4T	270mm	Aço	0-90mm	4T	1.17	-	30	1000	54,00€
52486	UNIÃO DE CORRENTES GANCHOS 3T	280mm	Aço	0-110mm	3T	1.21	-	11	1500	66,00€
52487	MORDAÇA DE MOLA 5T	220mm	Aço	0-20mm	5T	2.27	-	7	1000	63,00€
52502	MORDAÇA DE PRESSÃO PARA SOLDADURA	280mm	CrMo	0-110mm	-	0.84	10	30	540	33,50€
52503	MORDAÇA DE PRESSÃO PESCOÇO DE CISNE MAXILAR OSCILANTES	280mm	CrMo	0-105mm	-	0.85	10	30	540	35,00€
52504	MORDAÇA DE PRESSÃO TIPO U 9"	225mm	CrMo	0-50mm	-	1.14	-	30	480	27,60€
52505	MORDAÇA PESCOÇO DE CISNE	170mm	CrMo	0-40mm	-	0.27	36	72	2160	22,50€
52506	MORDAÇA PESCOÇO DE CISNE, MAXILAS OSCILANTES	170mm	CrMo	0-50mm	-	0.28	36	72	2160	16,00€
52507	MORDAÇA DE PRESSÃO PARÁGRAFO LATOEIROS	250mm	CrMo	0-80mm	-	0.77	5	30	420	32,50€
52511	MORDAÇA PARA SOLDADURA 18"	440mm	CrMo	0-225mm	-	1.31	-	20	280	44,50€
52512	MORDAÇA DE PRESSÃO SOLDADURA, MAXILAS OSCILANTES	450mm	CrMo	0-155mm	-	1.31	-	20	280	53,00€



52390



52474



52475



52476



52477



52478



52479



52480



52481



52482



52483



52484



52485



52486



52487



52502



52503



52504



52505



52506



52507



52511



52512

53983

215,00€

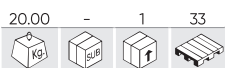

SUPORTE DE PEÇAS - PÁRA-BRISAS E COBERTURA



Capacidade	150Kg
Dimensões dobradas	1200x120x210mm
Peso	19,40Kg
Dimensões (CxLxA)	1200x700x635mm

53124

287,00€



CAVALETE UNIVERSAL TELESCÓPICO



Capacidade	100Kg
Dimensões dobradas	25x860x840mm
Peso	21,10Kg
Dimensões (CxLxA)	1380x860x1300mm

53125

477,00€

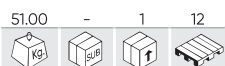

CARRO PARA ARMAZENAGEM DE PEÇAS

Capacidade	150Kg
Peso	51,00Kg
Dimensões (CxLxA)	140x920x20mm



50923

454,00€

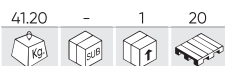

CARRO TRANSPORTADOR ESP. CHAPEIROS 340KG



REPOSIÇÕES DISPONÍVEIS

Capacidade	340Kg
Abertura	0-1100mm
Peso	41,20Kg
Dimensões (CxLxA)	1340x250x240mm

50839

180,00€



PORTA CARROS HIDRÁULICO 680KG



Capacidade	680Kg
Abertura	345-660mm
Peso	19,20Kg
Dimensões (CxLxA)	680x625x230mm

53079

89,00€

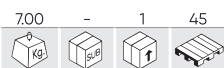

CAVALETE EN "X"



Capacidade	100Kg
Dimensões dobradas	660x1140x300mm
Peso	6,77Kg
Dimensões (CxLxA)	600x680x870mm

53080

99,00€

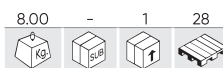

CAVALETE PARA PARA-BRISA



Capacidade	70Kg
Dimensões dobradas	1130x285x990mm
Peso	7,87Kg
Dimensões (CxLxA)	1130x610x990mm

52749

79,00€



CAVALETE PROFESSIONAL

REPOSIÇÕES
DISPONÍVEIS

Capacidade	220Kg
Dimensões dobradas	1030x905x500mm
Peso	6,25Kg
Dimensões (CxLxA)	1030x390x1000mm

53736

99,00€



CAVALETE SUPORTE PARA-CHOQUES



Capacidade	25Kg
Dimensões dobradas	600x310x1230mm
Peso	8,10Kg
Dimensões (CxLxA)	600x750x1060mm

53685

310,00€

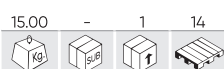

SUPORTE PARA PARACHOQUE



Capacidade	25Kg
Dimensões dobradas	960x865x95mm
Peso	14,50Kg
Dimensões (CxLxA)	762x1118x1346mm

54579

213,00€

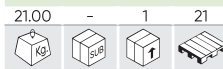
SUPORTE MÓVEL PARA ARMAZENAMENTO DE
PARA-CHOQUES

Capacidade	60Kg
Capacidade da barra	15Kg
Peso	21,00Kg
Dimensões (CxLxA)	1200x1200x2150mm

53134

145,00€

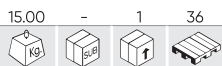

SUPORE PARA PINTURA AJUSTÁVEL

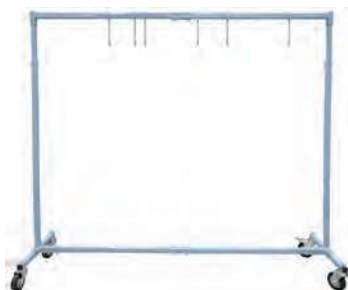

Capacidade	150Kg
Altura mínima de elevação	1270mm
Altura máxima	2030mm
Contém	6 Ganchos/Hooks
Peso	14,70Kg
Dimensões (CxLxA)	1770x500x2030mm

53126

243,00€



SUPORE BASCULANTE PARA PINTURA



Capacidade	50Kg
Contém	6 Braços de sujeição/Support arms
Peso	19,70Kg
Dimensões (CxLxA)	1220x250x165mm

52230

398,00€

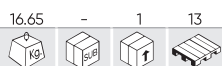

PLATAFORMA DE ALUMÍNIO TELESCÓPICA

Capacidade	150Kg
Dimensões dobradas	300x1090x900mm
Comprimento mínimo	1090mm
Comprimento máximo	1750mm
Altura mínima	250mm
Altura máxima	900mm
Material	Al
Conformidade com a diretiva europeia	EN131
Peso	16,65Kg
Dimensões (CxLxA)	300x1750x900mm



REPOSIÇÕES DISPONÍVEIS

50656

290,00€

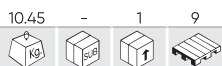

JOGO 2 PLATAFORMAS DE ALUMÍNIO

Capacidade	100Kg
Dimensões da plataforma grande (CxLxA)	1300x300x550mm
Dimensões da plataforma grande dobrada (CxLxA)	1300x300x140mm
Dimensões da plataforma pequena (CxLxA)	1000x300x300mm
Dimensões da plataforma pequena dobrada (CxLxA)	1000x300x140mm
Material	Al
Contém	11897, 15552
Conformidade com a diretiva europeia	EN131
Peso	10,45Kg



REPOSIÇÕES DISPONÍVEIS

50913

195,00€

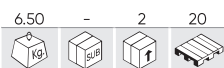

PLATAFORMA DE ALUMÍNIO GRANDE

Capacidade	100Kg
Material	Al
Conformidade com a diretiva europeia	EN131
Dimensões (CxLxA)	1400x300x800mm
Peso	6,50Kg
Dimensões dobradas	1400x300x14mm



KIT SUPORTE + MATERIAL DE CUIDADO DO VEÍCULO

50400

168,00€

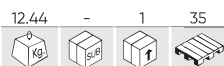

- 53705 SUPORTE DE PAREDE
- 51978 ROLO COBRE ASSENTOS
- 52057 ROLO DE FILM PARA VOLANTE
- 52058 CABO PARA ROLO DE FILM
- 50409 TAPETE ANÔNIMO EM PAPEL

50403

98,00€



- 52065 SUPORTE DE PAREDE
- 51978 ROLO COBRE ASSENTOS
- 52057 ROLO DE FILM PARA VOLANTE
- 52058 CABO PARA ROLO DE FILM

50410

168,00€

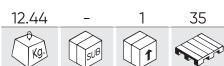

- 53705 SUPORTE DE PAREDE
- 52244 ROLO COBRE ASSENTOS
- 52057 ROLO DE FILM PARA VOLANTE
- 52058 CABO PARA ROLO DE FILM
- 50409 TAPETE ANÔNIMO EM PAPEL



53705

80,00€



SUPORE DE PAREDE PARA ROLO COBREASSENTOS, ROLO VOLANTE E TAPETES DE PAPEL



Cor	Verde/Green, Negro/Black
Peso	4,90Kg
Dimensões (CxLxA)	730x200x500mm

52065

45,00€

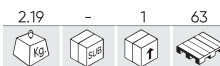

SUPORE DE PAREDE DE ROLO COBRE-ASSENTO



Cor	Verde/Green, Negro/Black
Comprimento	735mm
Peso	2,19Kg
Dimensões (CxLxA)	790x155x115mm

52057

6,80€



ROLO DE FILM PARA VOLANTE

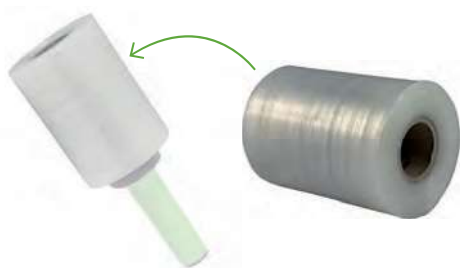

Diâmetro	90mm
Comprimento	180m
Compatível com	52058
Espessura	23MIL
Peso	0,62Kg
Dimensões (CxLxA)	128x90x90mm

52058

4,80€

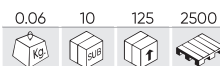

CABO PARA ROLO DE FILM COM REF.52057



Diâmetro	30mm
Comprimento	195mm
Compatível com	52057
Peso	0,06Kg
Dimensões (CxLxA)	195x55x35mm



51978 84,00€

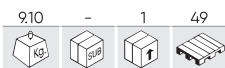

ROLO COBRE ASSENTOS 25MC 250U.



Peças	250
Material	25mc
Peso	9,70Kg

52244 84,00€

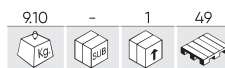

ROLO COBRE ASSENTOS DESENHO ANÔNIMO 25MC 250UD



Peças	250
Material	25mc
Peso	9,55Kg

50409 26,00€

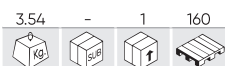

TAPETE ANÔNIMO EM PAPEL



Peças	250
Material	Papel/Paper
Peso	3,54Kg
Dimensões (CxLxA)	457x430x25mm

51824 37,00€

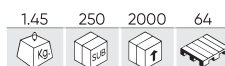

PROTECTOR DE VOLANTE PLÁSTICO - 250UDS



Peças	250
Material	Plástico/Plastic
Espessura	18µm
Peso	1,45Kg
Dimensões (CxLxA)	320x320x165mm

50916 0,99€

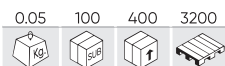

KIT MANUTENÇÃO DE LIMPEZA EM BOLSA INDV.

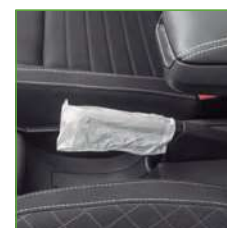

53226

14,90€

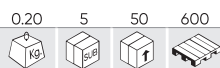

CAPA PARA ASSENTO DE CARRO



Marcas	Universal
Material	Nylon
Peso	0,20Kg
Dimensões (CxLxA)	345x270x5mm

51622

27,00€



PROTECTOR MAGNÉTICO DE COBERTURA DE ALETAS E FACHADAS



Tipo	Imantado/Magnetized
Material	PVC
Peso	0,45Kg
Dimensões (CxA)	1300x640mm

53922

29,00€



SUPORE DE PAPEL PARA PAREDE



PAPEL NÃO INCLUSO

Material	Acero inoxidable/Stainless steel
Altura mínima	480mm
Altura máxima	690mm
Rolo de papel	380mm
Dimensões dobradas	450x270x480mm
Peso	1,55Kg
Dimensões (CxLxA)	4550x210x690mm

53921

39,00€

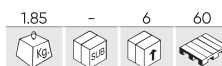

PORTA ROLO DE PAPEL



PAPEL NÃO INCLUSO

Material	Acero inoxidable/Stainless steel
Altura	975mm
Rolo de papel	380mm
Peso	1,85Kg
Dimensões (CxLxA)	450x345x975mm

CABO EXTENSÍVEL MULTIFUNÇÃO

REF.	MIN.	MAX.					€
52497	1200mm	530mm	0.29	6	48	480	27,00€
53196	1600mm	710mm	0.37	6	48	384	33,00€



TRAVÕES

REPOSICIONADORES

230

SANGRADORES DE TRAVÕES

233

MANUTENÇÃO

235



54584

127,50€

3.65 - 5 75



CONJUNTO DE FERRAMENTAS DE PISTÃO DE TRAVÃO

Ferramenta de reposicionamento da pinça de travão

Fuso 2 em 1 direito e esquerdo com pega

Contraplaca (Ø90mm)

Fuso pneumático para adaptadores de pistão de travão (260mm)

Adaptador de 3/8" (9,5 mm) para ferramenta de pistão de travão com 2 pinos

Adaptador universal regulável com 2 pinos

Adaptador universal regulável com 3 pinos



REPOSIÇÕES
DISPONÍVEIS



52636

114,00€

3.16 - 5 80



CONJUNTO DE RECOLHA DE EMBOLOS DE TRAVÕES PNEUMÁTICO

0 General Motors (Ø pistões 2-1/2 pol.)

2 Citroën XM/Xantia (F/R), HONDA

Audi (F), Fiat, Alfa romeo (F), Ford Fiesta (F), Isuzu (F), Honda Concesto (F), Jaguar XJ6/XJ40 (F/R), BMW 318is / 320i / 325T / 518i / 525i-1x / 740i / 850ci / M5 (F), Mercedes BENZ 190/200/300/420/560 serie (F), Mitsubishi Colt (F), Nissan Miera/Stanza/Sunny (F), Rover Austin/Metro200-400 series/Maestra/Montego (F), Toyota Camry (F), Volvo (F), VW Passat/Golf GTI (F)

4 Ford Australia/NZ Telstar, Mazda (R), Saab 9000 (R)/Lumina, Toyota, Fiat 164 2.0 (R), Alfa Romeo Prelude/CRS 16i, Honda Saturn (R)/Grand Prix, GM

5 Adaptador 3/8"

6 Nissan Primera, VW Golf IV

Audi 80/90/V8+100/Coupe E (R), Rover 800 ABS, Subaru L+Z (R), Ford Sierra ABS/Granada/Scorpio ABS (R), Nissan Bluebird 1.8 Turbo/Silvia Turbo/Primera2.0i LS-GS-GSX (R), Peugeot 405 1.9Gi/Gri/Sri/Gtxi/MI 16/605 2.0 Sri (R), Toyota Cecilia/Corolla GT/MR2 (R), VW Golf Gti/Jeta Synchro/Jetta Gti 16v, Passat CL, GL, GT, GT 16v, Corrado 16V scirocca GTX 16V(R), Citroën, Alfa romeo, Fiat, Honda, Jaguar, Renault, Saab, Seat, Lancia

8 General Motors (pistões de 1-7/8 pol.)

9 General Motors (Ø pistões 2-1/8 pol.)

A(Z) Renault (R21-Laguna (R))

E Nissan Maximas/Cefiro

F(G) Opel (Rear disk)/ Fiat Stilo

K Citroën C5

K1 Renault, Citroën C5

K2 Renault, Citroën, Audi A8, S8

M Ford, Mini Cooper, Nissan Primera 03

Saab, Honda, Alfa Romeo 164 2.0 Twin Spark/2.0 Turbo (88-)/3.0 V6, Audi 200 (80-)/ Coupe GT SE (82-)/80/90/100/200/Quattro (87-)/90/20V (88-), Ford Mondeo 2.0/Ghia, Lancia Themaalte (85-), Volkswagen Golf II GTI (83-87)/Sirocco 16V (84)



53978

38,90€

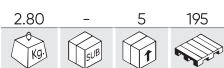

CONJUNTO DE REPOSICIONADOR DE TRAVÕES 23 PEÇAS

0	General Motors (Ø pistões 2-1/2 pol.)		
1	Disco		
2	Citroën XM, Xantia		
3	Alfa Romeo, Audi, Austin, BMW, Ford, Honda, Jaguar, Mercedes-Benz, Mitsubishi, Nissan, Rover, Toyota, VW		
4	Alfa Romeo 164 2.0, Ford, Mazda, Saab 9000, Subaru		
5	Adaptador 3/8"		
6	Nissan Primera, VW, Golf IV		
7	Audi 80;90;V8+100, Ford Sierra ABS+Scorpio de 1985, Honda Prelude, Nissan Silvia 1.8 turbo, Rover 8000, Saab 9000, Subaru L+Z, VW Golf + Passat		
8	General Motors (pistões de 1-7/8 pol.)		
9	General Motors (Ø pistões 2-1/8 pol.)		
10	VW	K1	Citroën
A	Renault R21, Laguna	K2	Citroën
E	Nissan Maxima, Cefiro	M	Ford
F	Opel	N	Saab, Honda
K	Citroën C5	O	Disco

Fiat Tipo TD 16V, Uno Turbo(85) Crama TD, Honda CRX, Alfa Romeo 155 1.8-2.01, 164 TD (93), 164 3.0 V6 (91); Audi 80, 90, & V8's, A3, A4, A6, A8 (pinza trasera); Citroën ZX 2. Ql 16v; Fiat Tipo TD 16V, Uno Turbo (85-), Crama TD; Ford Sierra (ABS bak), Granada (85-); Ford (Australia & NZ) Thunderbird Turbo; Honda CRX, 1.6l-16V (88-90), Accord 1800 (84-85), 2.0i (86-), Preludi 16V (88-), LegendV6; Jaguar XJ serie 40; Lancia Dedra. 2.0 Ei Tur(93), Delta 1.6 Gti. (92), The. majE 16v(92), Thema. 2000 Turbo. Kappa 2.Q-2.4LS, 2.4TD.



51059

99,00€



CONJUNTO REPOSICIONADOR DE TRAVÕES

0	Disco
1	Disco
2	Citroën XM, Xantia (F/R)
3	Alfa Romeo, Audi, Austin, BMW, Ford, Honda, Jaguar, Mercedes-Benz, Mitsubishi, Nissan, Rover, Toyota, VW
4	Alfa Romeo 164 2.0, Ford, Mazda, Saab 9000, Subaru
5	Adaptador 3/8"
6	Nissan Primera, VW-Golf IV
7	Audi 80, 90, V8 +100, Ford Sierra ABS+Scorpio ab 85,Honda Prelude Nissan Silvia 1.8 turbo, Rover 8000, Saab 9000, Subaru L+Z, VW-Golf +Passat
8	General Motors (pistões de 1-7/8 pol.)
9	General Motors (Ø pistões 2-1/8 pol.)
11	Disco para Tipo S
12	Disco para BMW mini
A	Disco de dois pinos 1-3 / 16 " para Renault R21, Laguna
B	Ford, Lincoln, Subaru
C	Mini Austin
D	Citroën, Renault
E	Cefiro, Maxima
F	Opel Corsa, Astra, Zafiraand Vectra
G	Opel (disco traseiro)

Alfa Romeo 155 1.8-2.0 164 TD(93) 164 3.0 V6(91) Audi, 80, 90, A3, A4, A6, A8 Citroën ZX 2 Ql 16V, Fiat Tipo TD 16V, Uno Turbo(85) Crama TD, Ford Sierra(ABS bak), Granada (85), (Australia & NZ) Thunderbird Turbo, Honda CRX, 1.6l-16V (8-90), Accord 1800(84-85)2.0i, Prelude 16V(88), Legend V6, Jaguar XJ40series, Lancia Dedra 2.0 Ei Tur(93), Delta 1.6Gti, Nissan, Peugeot, Renault, Seat, Subaru, Volvo V40 & S40

K	Citroën C5
K1	Citroën, Renault
K2	Citroën, Renault
M	Ford
N	Saab, Honda
O	GM Motors
P	Audi, BMW, Ford, Lancia, Proton, Renault, Rover, VW
R	Ford (Australia & NZ) Telstar, Laser, Mazda 323 Gti,GTX(86-), 929(82-), RX7(81-), 626 16V (87-), 626 GT (86-),929 V6(88-), Mitsubishi Galant GL Si, Toyota Celica, Corolla GT, MR2
S	Audi 100TQi(91), BMW 740i 8cyl.(91), Lancia Delta 1.9 TD(95), Proton 416, Renault-most models, Renault Laguna 2.0 (94), Laguna 2.2 D(95), Safrane 2.0-2.2 TD V6, Rover 623 Si, Volkswagen Golf Gti Mk 3&4, Passat VR6,Vento GT(92)
Z	BMW, Mini

Grampo de rotação direita (com rosca à direita)

Grampo de rotação esquerda (com rosca à esquerda)

Pin Ø 3.0 / Pin Ø5.5 (100g Grasa)



52330

99,00€

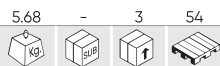

CONJUNTO REPOSICIONADOR DE TRAVÕES 50 PEÇAS

- 0 General Motors (Ø pistões 2-1/2 pol.)
- 1 Disco
- 2 Citroën XM, Xantia u.a.
- 3 Alfa Romeo,Audi, Austin, BMW, Ford, Honda, Jaguar, Mercedes-Benz, Mitsubishi, Nissan Rover, Toyota, VW
- 4 Alfa Romeo 164 2.0.Ford, Mazda, Saab 9000, Subaru
- 5 Adaptador 3/8"
- 6 Nissan Primera, VW-Golf IV
- 7 Audi 8.0,9.0,V8 +100, Ford Sierra ABS+ Scorpio ab 85, Honda Prelude, Nissan Silvia 1.8 turbo, Rover 8000, Saab 9000, Subaru L+Z, VW-Golf+ Passat
- 8 General Motors (pistões de 1-7/8 pol.)
- 9 General Motors (Ø pistões 2-1/8 pol.)
- 11 Disco para Tipo S
- 12 Disco para BMW mini
- A Nissan Primera 2.0, Bluebird
- A1 Ford Transit 06,Transit Connect 02,Tourneo Connect 02,Mondeo 00-07,C-Max 03, Focus 04
- B Ford, Lincoln, Subaru
- B1 Ford S-max 06,Scorpio 94-06,Mondeo 07,Kuga 08,Galaxy 00-06,Focus RS 03,Fiesta 01-02,Cougar 98-01
- C Nissan Primera (02), Opel Vectra 02-,Toyota Avensis
- D Citroën, Renault
- E Cefiro, Maxima
- F Peugeot 206 CC/Hdi/Gti. Ela exige uma chave de 16mm com pistões traseiros
- F1 Fiat Ducato
- G Opel
- G1 Volkswagon Golf V / VI
- J Alfa Romeo 155 1.8-2.0 164 TD(93) 164 3.0 V6(91), Audi 80,90,A3,A4,A6,A8, Citroen ZX 2 Ql 16V, Fiat Tipo TD 16V, Uno Turbo (85) Crama TD, Ford Sierra (ABS bak). Granada (85) Crama TD, Ford Sierra (ABS bak). (Australia& NZ) Thunderbird Turbo, Honda CRX, 1.6l-16V (8-90). Accord 1800 (84-85) 2.0i. Prelude 16V (88), Legend V6, Jaguar XJ 4, Oseries, Lancia Dadra 2.0, Ei Tur (93), Delta 1.6 Gti, Nissan, Peugeot, Renault, Seat, Subaru, Volvo V40 &S40.
- K Citroën C5
- K1 Citroën
- K2 Citroën, Renault
- M Ford
- N Saab, Honda
- O Disco
- P Audi, BMW, Ford, Lancia, Piston, Renault, Rover.
- P1 Peugeot 307, 308



- Alfa Romeo 164 2.0 1., Fiat Uno, Turbo ie-Barchetta, Ford Escort MK III, IV, Orion, XR31,
- G Focus(98-) push-back pistons, Honda-most models (push-back pistons), Rover-most models(push-back pistons), Subaru Lserie & Serie 2
- Ford(Australia& NZ) Teslar, Laser, Mazda 323 Gti, GTXX (86), 929 (82-), RX7(81-), 626
- R 16V(87-) 626 GT (86-), 929 V6 (88-), Mitsubishi Galant GL Si, Toyota Celica, Corolla GT, MR2
- Audi 100 TQ(91), BMW 740i 8cyl (91), Lancia Delta 1.9 TD (95). Proton 416, Renault-most models, Renault Laguna 2.0 (94), Laguna 2.2 D (95) Safrane 2.0-2.2 TD V6, Rover 623 Si, Volkswagen Golf Gtu Mk I&IV, Passat VR6, Vento GT (92)
- T Rover 220 C Turbo (95)
- V Rover 216 Gti 16V,820 Si 2.0(93),825 SD 2.5 (93)
- Z Renault
- IV Iveco Daily, Volkswagen Passat 2.0 TDI 09

52906

38,00€

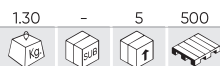

CONJUNTO DE REPOSICIONADOR DE TRAVÕES UNIVERSAL

- Adaptador de 2-PINS ajustável do pistão do freio
- Adaptador de 3-PINS ajustável do pistão do freio
- Haste roscado central
- Manivela
- Adaptador móvel
- A parte central móvel
- Alfa Romeo 164 2.0, Ford, Mazda, Saab 9000, Subaru, Nissan Primera, VW, Audi, Ford Sierra Abs + Scorpio Ab 85, Honda Prelude, Nissan Silvia 1.8 Turbo, Rover 8000, Saab 9000, Ford, Opel, BMV, Lancia, Proton, Renault, Rover, Peugeot 307, 308 A3- Iveco Daily, Volkswagen Passat 2.0 Tdi 09, Renault Laguna.



REPOSIÇÕES DISPONÍVEIS



53683

116,00€

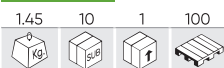

PISTOLA PARA POSICIONAR FREIOS - PERFIL BAIXO



Pressão do trabalho	5-8BAR
Pressão de ar máxima	14BAR
Entrada de ar	1/4"
Peso	1,45Kg
Dimensões (CxLxA)	313x275x80mm

51283

78,00€



PISTOLA PARA POSICIONAR FREIOS



Pressão do trabalho	5-8BAR
Pressão de ar máxima	14BAR
Entrada de ar	1/4"
Peso	1,33Kg
Dimensões (CxLxA)	298x277x77mm

52315

16,00€

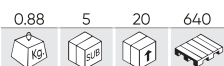

SEPARADOR DE EMOLOS DE TRAVÕES



Abertura	80mm
Material	CSTL
Peso	0,88Kg
Dimensões (CxLxA)	170x160x65mm

54589

31,50€

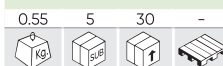

ADAPTADOR UNIVERSAL PARA PURGADOR DE TRAVÕES



Pressão máxima	3,5BAR
Comprimento	114-180mm
Conexão rápida	3/8"
Diâmetro	28-70mm
Peso	0,48Kg

54588

499,00€

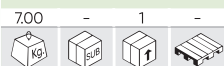

PURGADOR DE TRAVÕES ELÉTRICO

Pressão do trabalho	0,6-3,0BAR
Adaptadores	16
Potência	48W
Medição de voltagem em corrente alternada (AC)	90-240V
Medição de voltagem em corrente contínua (DC)	12-24V
Caudal	2,2LPM
Peso	7,00Kg
Dimensões (CxLxA)	240x200x280mm



52191

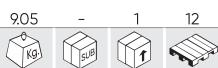

SANGRADOR DE TRAVÕES

Peças	16
Pressão do trabalho	0-4BAR
Entrada de ar	1/2"
Adaptadores	11+2 Adaptadores univerales/Universal adapters
Peso	9,05Kg
Dimensões (CxLxA)	385x385x460mm

REPOSIÇÕES
DISPONÍVEISVÍDEO
TUTORIAL

52275



SANGRADOR DE TRAVÕES

Peças	5
Capacidade	0,75L
Pressão do trabalho	6-12BAR (87-174PSI)
Entrada de ar	1/4"
Consumo real de ar	180L/min
Peso	0,79Kg
Dimensões (CxLxA)	280x210x130mm



38,00€

54721



CONJUNTO DE CHAVES DE SANGRIA DE TRAVÃO

Peças	7
Medida	7, 8, 9, 10, 11, 12mm
Peso	1,43Kg
Dimensões (CxLxA)	350x25x65mm



67,00€

54016

76,00€

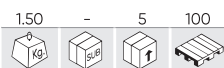

BOMBA DE COMPROVAÇÃO DE PRESSÃO

Peças	20
Nível de vácuo	-0,75BAR (-20PSI)
Pressão de ar máxima	3BAR (40PSI)
Peso	1,50Kg
Dimensões (CxLxA)	345x90x240mm



54372

157,00€



CONJUNTO DE TESTADORES DE TRAVÕES COM E SEM ABS

x1	Adaptador Teves
x1	Encaixe Giratório de 45°
x1	Encaixe Giratório de 90°
x2	Encaixes Retos de 7/16-24 de polegada
x2	Encaixes Retos de 1/4-28 de polegada
x2	Encaixes Retos de 3/8-24 de polegada
x2	Encaixes Retos de 5/16-24 de polegada
x2	Encaixe Reto M10-1,5
x2	Encaixe Reto M8-1,25
x2	Adaptador de Drenagem M10-1,0
x2	Encaixes Retos de 7/16-20 de polegada
x2	Encaixe Reto M7-1,0

Audi (TT (2007-), A4 (2001-), A6 (2005-), A8 (2003-), Q7 S5, S6, S8, Porsche (Cayenne, Macan, Cayman), Mercedes-Benz (ML320, Classe C), Ford (Mondeo, Fiesta, Focus, Edge), BMW (Series 3 -generación E36 / 5), Alfa Romeo, Jaguar (XF), Vauxhall, Volkswagen, Chrysler, Mini, SAAB



54135

82,00€

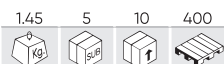

KIT DE CHAVES DE CAIXA PARA PINÇA DE TRAVÃO

1/2"	x2	14x38, 22x38mm
1/2"	x3	11,50x38, 15x38, 20x38mm
	x4	10, 12.50, 14, 19mm
	x1	10mm
3/8"	x4	H11x100, H7x70, H7x92, H9x50mm
	x2	7x24, 8x24mm
1/4"	x1	9x20mm

Audi (A4, A5, S5, S8, Q5, Q7), Porsche (Cayenne, Macan, Cayman), Mercedes Benz, Ford, BMW, Alfa Romeo



52434

125,00€

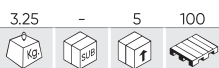

KIT PARA REPARAÇÃO DE TRAVÕES

- x2 Chaves para porcas de freio
- x1 Alicate de mola de freio
- x1 Chave de fenda de impacto
- x3 Soquetes de chave de fenda
- x1 Ferramenta de montagem
- x1 Chave de fenda com articulação universal
- x1 Ferramenta de freio especial
- x1 Escova de limpeza
- x1 Escova para limpeza de latão
- x1 Ferramenta de montagem
- x1 Alicate para cabo de freio
- x1 Arquivo de pinça de freio



52625

9,00€

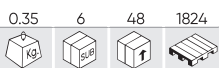

ALICATE PARA MOLAS DE TRAVÃO

Abertura	195mm
Material	CSTL
Comprimento	310mm
Peso	0,35Kg



52455

16,00€

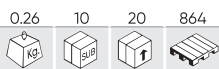

APALPA FOLGAS PARA PASTILHAS DE TRAVÕES

Peças	8
Medidas	2, 3, 4, 5, 6, 8, 10, 12mm
Material	ABS
Peso	0,26Kg
Dimensões (CxLxA)	200x155x30mm



51839

24,00€

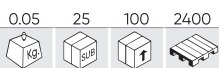

COMPROVADOR DE FLUÍDO DE FREIO



Bateria	1 Pila/Battery AAA
Peso	0,05Kg
Dimensões (CxLxA)	215x127x35mm



FERRAMENTA ESPECIAL

SISTEMA DE LUBRIFICAÇÃO	238	SUSPENSÃO	265
SISTEMA DE INJETORES	244	ESCAPE	271
CILINDROS	249	SISTEMA ELÉTRICO	271
EMBREAGEM	258	REPARAÇÃO DE ROSCAS	275
SISTEMA DE REFRIGERAÇÃO	260	MOTOS	277
SISTEMA DE AR CONDICIONADO	262	EXTRATORES	277
TRANSMISSÃO	264		



54068

120,00€

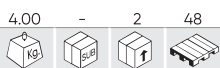

KIT DE CHAVES PARA FILTROS DE ÓLEO DE ALUMÍNIO, 19 PÇS



REPOSIÇÕES DISPONÍVEIS

Nº DE PEÇAS	FACES	Ø
05101 Mazda, Mitsubishi	15	100,5mm
0595 Nissan, Toyota	15	94,5mm
0592 Nissan, Subaru	15	92mm
0579 Toyota, Honda, Mitsubishi, Subaru, Mazda, Lsuzu	15	79mm
915 Volvo	16	87mm
901L Lexus	14	79,5mm
901T Toyota	14	70mm
901-1 Toyota	14	63-64mm
902 Ford, Mazda	14	66,5mm
1284 Mercedes Benz, Dodge, Jeep	14	84mm
903B Mercedes Benz	14	74mm
24mm BMW, Saturn, Opel, Chrysler, Jeep	6	24mm
27mm Mercedes Benz	6	27mm
30mm Audi, Volkswagen	6	30mm
32,5mm Opel, BMW, Audi, Volkswagen	6	32,5mm
36mm Opel, BMW, Mercedes Benz, Volkswagen	6	36mm
38mm Opel	6	38mm
917 Universal		55-90mm



51332

98,00€

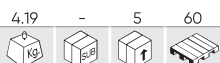

KIT DE EXTRACTORES PARA FILTROS OLEO



REPOSIÇÕES DISPONÍVEIS

Nº DE PEÇAS	FACES	Ø
901 Toyota, Nissan, Fiat Daihatsu	14	65mm
902 Toyota, Daihatsu	14	67mm
903 VW, Mercedes, BMW, Opel, Audi	14	74mm
903-1 GM/AC, Wix, Ford, Isuzu	15	75mm
903-2 VW, Audi, Seat, BMW, Renault	8	74mm
903-3 Audi, Rover, Chrysler	15	74mm
903-4 Toyota, Lexus	14	73mm
903-6 Schlepper, Baumashinen	12	75mm
918 Rover, Chrysler, Audi	15	74mm
904 Nissan, Ford	15	79mm
905 GM, Chrysler	15	73mm
905-1 BMW, Mercedes, Opel, Audi, VW	14	74mm
906 Baumashinen, Schlepper	18	84mm
907 Mitsubishi, Toyota	15	89mm
908 Nissan, Toyota	15	91mm
915 Honda Accord, Mitsubishi, Isuzu	15	90mm
910 Toyota, Alfa Romeo, Ford	15	95mm
911 Fiat, Renault, Citroën	12	80mm
911-1 Subaru, Toyota, Honda, Nissan	15	80mm
914 Mazda, Toyota	15	101mm
909 Isuzu, Nissan	15	92mm



CHAVE EXTRAÇÃO PARA FILTROS DE ÓLEO

REF.	DESCRIÇÃO							€
52311	CHAVE EXTRAÇÃO PARA FILTROS DE ÓLEO 42MM	VAG	0.13	6	72	1728	20,50€	
52312	CHAVE DE EXTRAÇÃO PARA FILTROS DE ÓLEO 74X14C	VW, OPEL, MERCEDER, BMW, AUDI	0.10	10	100	1000	9,00€	
52313	CHAVES DE EXTRAÇÃO DE FILTROS DE ÓLEO 86X16C	VOLVO	0.20	6	68	1008	8,00€	
52314	CHAVES DE EXTRAÇÃO DE FILTROS DE ÓLEO 87X16C	BMW, VOLVO	0.20	5	50	600	26,60€	
52809	EXTRACTOR PARA FILTRO DE ÓLEO - TOYOTA	TOYOTA	0.15	10	100	1000	8,50€	
53441	CHAVE EXTRAÇÃO PARA FILTROS DE ÓLEO 76X14C	-	0.20	5	20	800	9,80€	



52615 112,00€

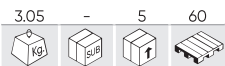

EXTRATOR PARA FILTRO DE ÓLEO - 9 PEÇAS

1/2"	x1	Universal	63 - 83mm
		Mercedes Benz, Smart	27mm
x3		GM, Opel, Vauxhall, Mercedes Benz	32mm
		Mercedes Diesel, BMW, Mini, Ford	36mm
		Toyota (Allion, Auris, Corolla, Prius, Voxy, etc.)	64,5mm
3/8"	x3	Toyota, Lexus (6 Zyl.)	64,5mm
		Audi, BMW, Ford, Toyota, Volkswagen, Porsche, Mercedes-Benz	74,2mm
	x1	Hunday, Kia	88,8mm
	x1	BMW 3+5+X, Volvo	86,6mm



53008 15,50€

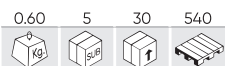

EXTRATOR PARA FILTRO OLEO FORD, CITROËN, PEUGEOT 2.0, 2.2 HDI, TDCI

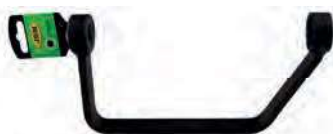

Marcas	FORD, CITROËN, PEUGEOT
Material	CrMo
Medida	27mm
Medida do quadrado	1/2"
Peso	0,60Kg
Dimensões (CxLxA)	310x125x20mm

52518 115,00€



EXTRACTOR DE FILTROS DE CAMION



Marcas	Universal
Material	CSTL, CrMo
Diâmetro	95-165mm
Medida do quadrado	1/2"
Peso	1,40Kg

51352

9,80€

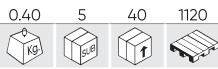

EXTRATOR PARA FILTRO DE ÓLEO DE PATILHA PLANA



Marcas	Universal
Material	CSTL
Diâmetro	57-118mm
Medida do quadrado	3/8"-1/2"
Peso	0,40Kg

51353

11,50€

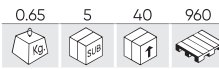

EXTRATOR PARA FILTRO DE ÓLEO DE PATILHA REDONDA



Marcas	Universal
Material	CSTL
Diâmetro	72-136mm
Medida do quadrado	3/8"-1/2"
Peso	0,65Kg

51934

11,50€

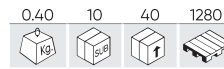

EXTRATOR FILTRO DE ÓLEO DE PATILHA PLANA MAGNETIZADO



Marcas	Universal
Material	CSTL
Diâmetro	57-118mm
Medida do quadrado	3/8"-1/2"
Magnetizado	Si/Yes
Peso	0,40Kg

51923

12,50€



EXTRATOR FILTRO DE ÓLEO DE PATILHA REDONDA MAGNETIZADO



Marcas	Universal
Material	CSTL
Diâmetro	72-136mm
Medida do quadrado	3/8"-1/2"
Magnetizado	Si/Yes
Peso	0,56Kg

54542

23,00€

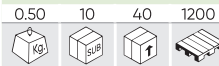

EXTRATOR DE FILTRO DE ÓLEO AJUSTÁVEL (60-80MM)



Marcas	Universal
Material	40Cr
Diâmetro	60-80mm
Medida do quadrado	1/2"
Peso	0,47Kg

54543

37,00€

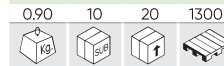

CHAVE AJUSTÁVEL PARA FILTRO DE ÓLEO (80-105 MM)



Marcas	Universal
Material	40Cr
Diâmetro	80-105mm
Medida do quadrado	1/2"
Peso	0,86Kg

53206

39,00€

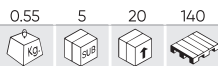

CONJUNTO DE 5 VARAS PARA VERIFICAR O ÓLEO - BENZ/AUDI

	Mercedes-Benz	920mm	- Código de transmissão: 716.5,722.7,722.8.
	Mercedes-Benz	930mm	- Ano de fabrico: 1988-1997. - Códigos do motor: 103,104,111,119,120,137,604,605,606,611,612,613,628,642,647,648.
	Mercedes-Benz	930mm	- Ano de fabrico: 1996-2005. - Códigos do motor: 103,104,111,112,113,119,120,137,271,272,604,605,606,611,612,613,628,642,646,647,648.
	Mercedes-Benz	1200mm	- Código de transmissão: 722.6.
	Audi	1160mm	- AUDI 100 motores.



REPOSIÇÕES DISPONÍVEIS

51354 13,20€

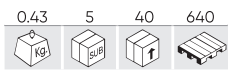

PINÇA EXTRATORA DE FILTROS DE ÓLEO



Marcas	Universal
Material	CrV
Abertura	80-120mm
Peso	0,43Kg

53670 29,50€

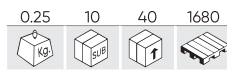

CHAVE DE FILTRO DE ÓLEO PARA VAG DSG 1/2" 24MM



Marcas	VAG
Material	CrMo
Medida	24mm
Medida do quadrado	1/2"
Peso	0,25Kg

54708 17,00€

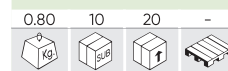

CHAVE DE FILTRO DE ÓLEO DE 12 PONTOS DE 46 MM PARA VW



Marcas	VW
Material	S
Medida	46mm
Peso	0,80Kg
Dimensões (CxLxA)	460x3,5x5,5mm

EXTRATOR DE FILTROS

REF.	DESCRIÇÃO	mm						€
52269	EXTRATOR DE FILTROS DE CINTA	ø 80 - 120mm	0.20	10	50	1600		7,00€
52677	EXTRATOR FILTROS AJUSTÁVEL Ø65-105MM	ø 65 - 105mm	0.32	10	40	720		17,00€
52678	EXTRACTOR DE FILTROS AJUSTÁVEL Ø110-155MM	ø 110 - 155mm	0.33	10	40	400		18,00€

52269



REPOSIÇÕES DISPONÍVEIS



52677



REPOSIÇÕES DISPONÍVEIS



52678



REPOSIÇÕES DISPONÍVEIS



EXTRATOR DE FILTROS

REF.	DESCRIÇÃO						€
52416	EXTRATOR FILTROS DE CORRENTE Ø150	0.37	5	50	900		14,00€
52417	EXTRATOR DE FILTROS DE CORRENTE 300MM - Ø160	0.90	5	25	800		28,00€
52607	EXTRATOR DE FILTROS DE CORRENTE Ø60-140MM	0.85	6	24	576		49,00€
52608	EXTRATOR DE FILTROS DE CORRENTE Ø60-195MM	0.95	6	24	480		49,00€



52416



52417



52607



52608

53735

45,50€

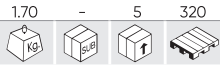

KIT DE CHAVES PARA BUJÃO DE CARTER, 23PCS



REPOSIÇÕES DISPONÍVEIS

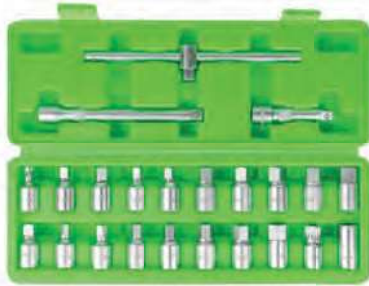

	x2	5/16", 3/8"
	x7	7, 8, 10, 11, 12, 13, 14mm
	x1	10mm
	x1	10mm
	x7	8, 9, 10, 12, 13, 14, 17mm
	x1	T45
	x1	M16
	x1	200mm
	x2	75, 150mm

15084

68,00€



MÓDULO DE EXTRAÇÃO DE TAMPÕES DE CÁRTER



	x2	5/16", 3/8"
	x7	7, 8, 10, 11, 12, 13, 14mm
	x1	10mm
	x1	10mm
	x7	8, 9, 10, 12, 13, 14, 17mm
	x1	T45
	x1	M16
	x1	200mm
	x1	150mm

TAMPAS DE DRENAGEM DE ÓLEO

REF.						€
13969	VAG	0.02	10	100	-	19,00€
53537	BMW	0.05	10	100	4000	14,50€
53538	FORD	0.10	10	100	4000	14,50€
53741	FORD, PSA	0.05	10	100	4000	14,00€



APRESENTAÇÃO EM SACOS DE 5 UNIDADES.



13969



53537



53538



53741

KIT REPARADOR DE ROSCAS DE TAMPÃO CÁRTER

REF.	DESCRIÇÃO					€
53235	KIT REPARADOR DE ROSCAS DE TAMPÃO CARTER (M-13)	0.25	10	40	-	10,40€
53236	KIT REPARADOR DE ROSCAS DE TAMPÃO CARTER (M-15)	0.35	10	40	-	12,00€
53237	KIT REPARADOR DE ROSCAS DE TAMPÃO CARTER (M-17)	0.35	10	40	-	12,90€
53238	KIT REPARADOR DE ROSCAS DE TAMPÃO CARTER (M-20)	0.40	10	40	-	18,40€



53235



53236



53237



53238

53472 12,00€

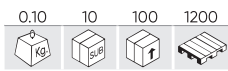

CHAVE PARA BUJÕES DE CARTER DE PLÁSTICO (VAG)



Marcas	VAG
Material	PT, CrV
Medida	14x1,5x22mm
Comprimento	100mm
Peso	0,10Kg
Dimensões (CxLxA)	130x100x25mm

52617 7,00€

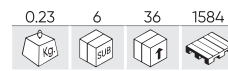

CHAVE QUADRADA PARA BUJÕES



Marcas	CITROËN, RENAULT, PEUGEOT
Material	CrV
Medidas	8-10mm
Comprimento	310mm
Tipo	Cuadrangular/Quadrangular
Peso	0,23Kg
Dimensões (CxLxA)	310x100x12mm

51337 50,00€

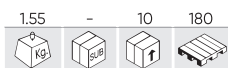

KIT DE REPARAÇÃO DE BUJÕES DE CARTER

	A	M15 x 1.5P
	B	M17 x 1.5P
	C	M20 x 1.5P
	D	M13 x 1.5P

	E	M13 x 1.5P
	F	M15 x 1.5P
	G	M17 x 1.5P
	H	M20 x 1.5P

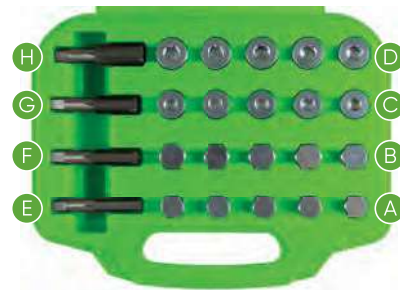

REPOSIÇÕES DISPONÍVEIS

54538 30,00€



KIT DE REMOÇÃO DE PARAFUSOS DE DRENAGEM DE ÓLEO DE PLÁSTICO (9 UNIDADES)

A	x1	3/8"	FORD
B	x1	3/8"	FORD
C	x1	3/8"	FORD
D	x1	3/8"	FORD, PSA
E	x1	3/8"	MERCEDES
F	x1	3/8"	DAF, MAN
G	x1	3/8"	BMW
H	x1	3/8"	GM
I	x1	3/8"	VAG



53473

39,50€

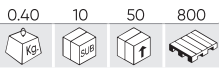

KIT EXTRATOR DE BUJÕES DE CÁRTER DE PLÁSTICO

A	x1	3/8"	FORD	OEM 1830727
B	x1	1/4"	VAG	OEM 06L 103 801
C	x1	1/4"	BMW	OEM 11137605018
D	x1	3/8"	PEUGEOT, CITROËN	OEM 9801444780, OEM18711598
E	x1	1/4", 3/8"		



54186

199,00€

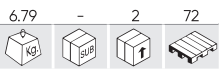

EXTRATOR PNEUMÁTICO PARA INJETORES

M20x1,0 10mm
M10x1,5 14mm
M14x1,5 15mm
M14x1,5 33mm
M16x1,5 18mm
M17x1,0 10mm
M18x0,75 10mm
M18x1,5 18mm
M22x1,5 15mm
M25x0,5 9mm
M25x1,0 13mm
M26x0,75 15mm
M27x0,75 10mm
M29x1,0 11mm
M31x0,75 15mm
M8x1,0 14mm
M8x1,25 14mm
M14x1,5 9mm
M14x1,5 9mm

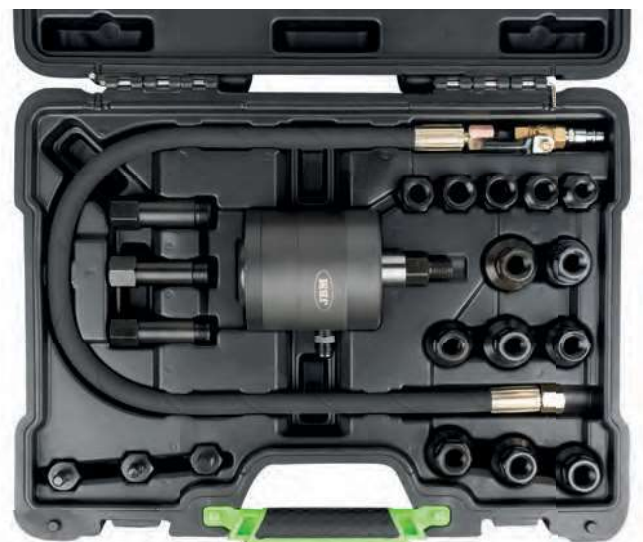

REPOSIÇÕES
DISPONÍVEIS



VÍDEO
TUTORIAL

54587

205,00€



EXTRATOR PNEUMÁTICO DE INJETORES DE COMBUSTÍVEL COM ADAPTADORES E GARRAS DE EXTRACÇÃO

M14x1,5 (16mm)
A M14x1,5 (13,5mm)
M14x1,5 (12mm)
M20x1,0 (10mm) / M14x1,5 (20mm)
B M18x0,75 (10mm) / M14x1,5 (20mm)
M17x1,0 (10mm) / M14x1,5 (20mm)
M8x1,25 (14mm) / M14x1,5 (14mm)
C M8x1,0 (14mm) / M14x1,5 (14mm)
M10x1,5 (14mm) / M14x1,5 (14mm)
D M14x1,5 (9mm) / M31x0,75 (15mm)
M14x1,5 (8mm) / M26x0,75 (15mm)
E M14x1,5 (33mm) / M14x1,5 (33mm)
M16x1,5 (18mm) / M14x1,5 (15mm)
M18x1,5 (18mm) / M14x1,5 (15mm)
E M22x1,5 (15mm) / M14x1,5 (33mm)
M20x1,5 (15mm) - M12x1,5 (18mm) / M14x1,5 (15mm)
M14x1,5 (9mm) / M27x1,0 (10mm)
M14x1,5 (9mm) / M27x1,0 (10mm)
M14x1,5 (9mm) / M25x1,0 (13mm)
M14x1,5 (9mm) / M27x0,75 (10mm)
F M14x1,5 (9mm) / M25x0,5 (9mm)
M14x1,5 (9mm) / M29x1,0 (11mm)
M14x1,5 (9mm) / M31x0,75 (15mm)
M14x1,5 (8mm) / M26x0,75 (15mm)



52858

298,00€

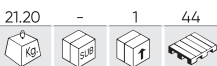

KIT DE EXTRAÇÃO DE INJECTORES



Martelos
1,6Kg (160mm)
2,7Kg (460mm)
5,1Kg (600mm)
Puxando a aderência com a abertura da forquilha
13,7x18mm (105mm)
12,7x19mm (130mm)
Vasos de fenda (6pt)
1/2" - 25, 27, 28, 29, 30mm (100mm)
Adaptador com rosca externa
M27x1,0, M25x1,0
Adaptador com rosca interna
M27x1,0
Eixo extrator injector
M17x1,0
Adaptador de martelo deslizante para extrator interno, externo e garra

51494

107,00€



KIT EXTRAÇÃO DE INJECTORES



A	M12 x 1,75	M8 x 1,5
B	M14 x 1,5	M17 x 1,5
C	M14 x 1,5	M27 x 1,0
D	M14 x 1,5	M12 x 1,75
E	M14 x 1,5	M8 x 1,5
F	M14 x 1,5	M8 x 1,5
G	M14 x 1,5	
H		
I		

54566

179,00€

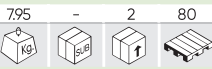

CONJUNTO DE EXTRATOR MANUAL DE INJETORES

Peças	25
Marcas	BOSCH, CAT, CUMMINS, DENSO, DELPHI, SIEMENS
Material	S
Peso	7,95Kg
Dimensões (CxLxA)	380x120x270mm



54345

15,00€

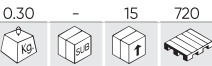

SPRAY DE GELO

Peças	1
Capacidade	400ml
Peso	0,30Kg
Dimensões (CxLxA)	200x60x70mm



16295

32,00€

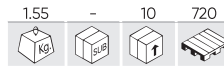

CONJUNTO DE 3 ADAPTADORES PARA EXTRACTOR DE INJECTORES (REF.54186)

Peças	3
Peso	1,55Kg
Dimensões (CxLxA)	160x130x40mm



54740

64,00€

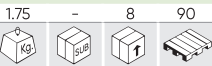

EXTRATOR DE INJETORES PARA FORD/VOLVO GTDI

Peças	6
Marcas	FORD, VOLVO
Material	S
Peso	1,75Kg
Dimensões (CxLxA)	650x55x103mm



54750

84,00€



EXTRATOR DE INJETORES PARA DIESEL ECOBLUE 2.0L

Peças	14
Marcas	FORD
Material	S
Peso	1,50Kg
Dimensões (CxLxA)	350x310x54mm



54598

33,00€

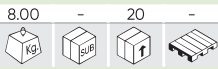

EXTRATOR DE INJETOR PARA MOTOR A DIESEL FORD 2.0L ECOBLUE

Peças	4
Marcas	FORD
Material	CSTL
Peso	8,00Kg
Dimensões (CxLxA)	370x120x280mm



54220

213,00€

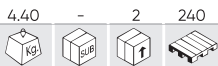

KIT DE FERRAMENTAS PARA INSTALAÇÃO E DESMONTAGEM DE INJETORES DE CÔMBUSTÍVEL PARA BMW MERCEDES

Peças	23
Marcas	BMW, MERCEDES BENZ
Peso	4,40Kg
Dimensões (CxLxA)	500x360x97mm



53069

98,00€

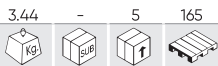

KIT DE EXTRAÇÃO DE INJETORES DIESEL PARA CITROËN, PEUGEOT, FIAT

Peças	9
Marcas	CITROËN, PEUGEOT, FIAT
Peso	3,44Kg
Dimensões (CxLxA)	300x220x65mm



52629

99,00€

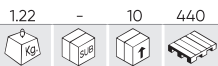

KIT DE EXTRAÇÃO PARA INJETORES MERCEDES

Peças	3
Marcas	MERCEDES BENZ
Material	CrV
Peso	1,22Kg
Dimensões (CxLxA)	210x145x50mm



53501 24,00€

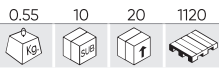

EXTRATOR DE BOMBA DE INJEÇÃO DIESEL BMW



Marcas	BMW
Peso	0,55Kg

53009 42,00€

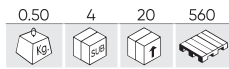

EXTRATOR DE TUBO DE INJEÇÃO DIESEL



Peças	3
Medida do quadrado	1/2"
Medida	M14, M17, M19
Peso	0,50Kg

52757 17,20€

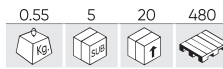

EXTRATOR UNIVERSAL DE AFORADORES



Diâmetro	75-160mm
Medida	24mm
Peso	0,55Kg
Dimensões (CxLxA)	345x210x90mm

53096 28,80€

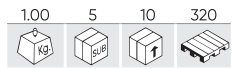

CHAVE PARA TAMPA DE AFORADORES



Diâmetro	89-170mm
Medida	15mm
Peso	1,00Kg
Dimensões (CxLxA)	150x150x100mm

53650

47,00€

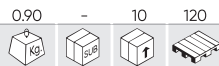

KIT LIMPADOR DE INJETORES DE VEDAÇÃO



REPOSIÇÕES DISPONÍVEIS

x3	Escovas de aço
x2	Escovas de silicone-nylon
x1	Extensor
x6	Tampões de fechamento para vedação da câmara de combustão
x1	Haste para inserção dos bujões de fechamento
x1	Escova de aço para limpeza da cabeça do cilindro

53522 24,00€

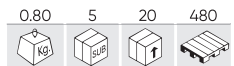

EXTRATOR DE ANILHAS DE INJETORES



Diâmetro	4,5-15mm
Comprimento	350mm
Peso	0,80Kg

51493

68,00€

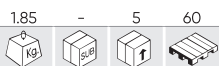

MEDIDOR E COMPROVADOR DE SISTEMA DE INJEÇÃO

Peças	31
Marcas	BOSCH, SIEMENS, DENSO, DELPHI
Material	PT, Cu-Zn
Dimensões (CxLxA)	410x325x87mm
Peso	1,85Kg



REPOSIÇÕES DISPONÍVEIS



54392

1.855,00€

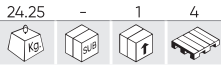

LIMPADOR E TESTADOR DE INJETORES GDI / EFI



VÍDEO
TUTORIAL

Tensão de funcionamento	220V (50/60Hz)
Potência dos ultra-sons	60W
Pressão do trabalho	0,1-10BAR
Pressão de ar máxima	5-8BAR
Temperatura de trabalho	-10~40°C
Peso	18,50Kg
Dimensões (CxLxA)	490x545x570mm



54391

221,00€

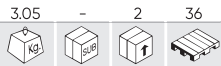

TESTE PARA BICOS INJETORES DE DIESEL



Gama de medição	0-60MPa
Conectores	M12(x1), M14(x2)
Peso	3,05Kg
Dimensões (CxLxA)	460x270x200mm

52488

28,00€

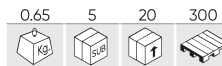

MEDIDOR DE COMPRESSÃO GASOLINA



Peças	2
Pressão do trabalho	0-21BAR
Peso	0,65Kg
Dimensões (CxLxA)	325x135x50mm

53997

48,00€



KIT DE TEST DE PRESSÃO - GASOLINA

Peças	10
Comprimento da mangueira de alta pressão	1100mm
Manômetro	0-10BAR
Peso	1,40Kg
Dimensões (CxLxA)	320x260x60mm



52599

230,00€

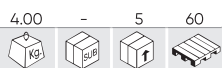

MEDIDOR DE COMPRESSOR PARA CIRCUITOS DE GASOLINA



Peças	39
Marcas	Multimarca/Multi-brand
Pressão do trabalho	0-10BAR
Peso	4,00Kg
Dimensões (CxLxA)	410x100x290mm

53490

275,00€

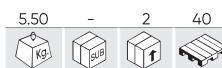

COMPROVADOR DE PRESSÃO PARA DIESEL E GASOLINA



Peças	44
Marcas	Multimarca/Multi-brand
Medidas	Bujia/Spark plug: 10,12,14,18mm
Pressão do trabalho	0-42BAR
Peso	5,50Kg
Dimensões (CxLxA)	500x360x100mm

54312

191,50€



KIT DE TESTE DE COMPRESSÃO - DIESEL



Peças	43
Marcas	Multimarca/Multi-brand
Medidas	10,12,14,18mm
Adaptadores	M22, M20, M24
Pressão do trabalho	0-48,3BAR
Peso	4,50Kg
Dimensões (CxLxA)	430x370x105mm

54373

395,00€

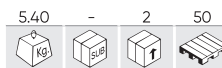

MANÓMETRO COMMON RAIL DE ALTA PRESSÃO



REPOSIÇÕES DISPONÍVEIS



Peças	32
Marcas	Multimarca/Multi-brand
Medidas	14, 17, 19mm
Adaptadores	M12x1,25, M14x1,25, M12x1,5, M14x1,5
Pressão do trabalho	0-1300BAR
Peso	5,40Kg
Dimensões (CxLxA)	448x115x302mm

52489

58,00€

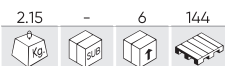

MEDIDOR DE COMPRESSÃO DIESEL



Peças	19
Pressão do trabalho	0-69BAR
Peso	2,15Kg
Dimensões (CxLxA)	395x317x81mm

52685

91,00€

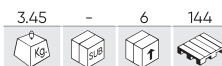

MEDIDOR DE COMPRESSÃO DIESEL PARA CAMIÓN



Peças	18
Pressão do trabalho	0-70BAR
Peso	3,45Kg
Dimensões (CxLxA)	400x320x80mm

52813

79,00€

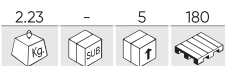

KIT DE CHAVES DE INJETORES 17 PCS



Peças	17
Marcas	MultiMarca/Multi-brand
Material	35CrMo
Peso	2,23Kg
Dimensões (CxLxA)	307x225x65mm

52273

44,00€



KIT DE CHAVES DE INJETORES



Peças	8
Marcas	Multimarca/Multi-brand
Material	35CrMo
Peso	1,40Kg
Dimensões (CxLxA)	287x205x63mm

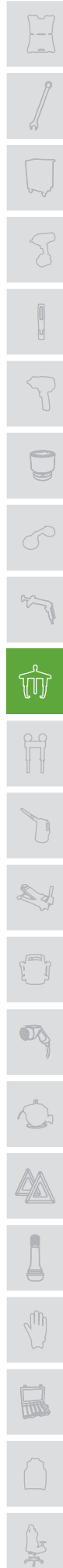

53489

68,00€

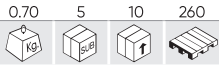

COMPROVADOR DE PRESSÃO DO TURBO



Peças	2
Pressão do trabalho	0,75-3BAR
Comprimento da mangueira de alta pressão	2m
Peso	0,70Kg
Dimensões (CxLxA)	260x170x60mm

53426

39,80€

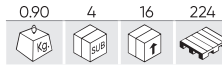

PROVADOR DE PRESSÃO E VÁCUO



Peças	9
Nível de vácuo	0-0,7Kg/cm2 (0-10PSIG) / 0-28inHg (0-70cmHg)
Peso	0,90Kg
Dimensões (CxLxA)	198x150x200mm

54590

108,00€

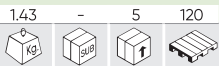

CONJUNTO PARA PURGAR SISTEMAS DE COMBUSTÍVEL A DIESEL



Peças	12
Marcas	Multimarca/Multi-brand
Compatível com	Inyectors Diesel/Diesel injectors
Peso	1,43Kg
Dimensões (CxLxA)	326x70x414mm

53330

38,50€



SET DE CHAVES PARA BOMBA INJETORA



Peças	5
Diâmetro	1/2", 1/4"
Peso	0,75Kg
Dimensões (CxLxA)	180x130x55mm

52801

26,00€

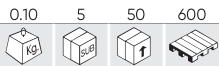

BOMBA INJETORA DIESEL



Marcas	Multimarca/Multi-brand
Compatível com	Inyectors Diesel/Diesel injectors
Peso	0,10Kg
Comprimento	340mm

52821

29,50€

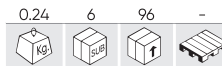

CHAVE DUPLA ABERTA PARA INJECTORES



Material	CrV
Compatível com	Inyectors Diesel/Diesel injectors
Peso	0,24Kg
Comprimento	290mm

PUNÇÕES

Permitem a aplicação de marcação digital ou alfabética em qualquer superfície de metal por método de indentação ou impacto. A área de trabalho arredondada evita rachaduras ou fraturas na superfície tratada.

REF.	DESCRIÇÃO					€
52422	PUNÇÕES ALFABÉTICOS E NUMÉRICOS 5MM	0.82	4	16	540	24,70€
53119	PUNÇÕES ALFABÉTICOS E NUMÉRICOS 8MM	1.94	3	6	504	55,00€
52882	PUNÇÕES DE NÚMEROS 6MM	0.30	10	60	1500	14,00€



52422



53119



52882

51120 41,00€

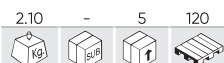

GRAMPO DE VÁLVULAS



Peças	6
Adaptadores	16, 19, 23, 25, 30mm
Peso	1,50Kg
Dimensões (CxLxA)	450x340x22mm

52693 26,50€



COMPRESSOR DE MOLA PARA VÁLVULAS



Compatível com	OHV, OHC, CHV
Peso	0,65Kg
Dimensões (CxLxA)	390x110x30mm

52734 53,00€



COMPRESSOR DE MOLA DE VÁLVULAS 45-145MM



Abertura	45-145mm
Peso	2,50Kg
Dimensões (CxLxA)	400x300x30mm

54318 105,00€



REBITADOR DE CORRENTE DE DISTRIBUIÇÃO

MARCAS	CHRYSLER JEEP MERCEDES
FERRAMENTAS OEM	103589016300, 112589026300, 602589003900, 602589023300, 602589046301



54525

77,00€

1,92	-	5	120

POLIDOR DE CILINDROS DO MOTOR

Peças	7
Medidas	2" - 7", 1-1/4" - 3-1/2", 1" - 2-3/4", 3/4"-2"
Peso	1,50Kg



POLIDORA DE CILINDROS

REF.	DESCRIÇÃO					€
52591	POLIDORA DE CILINDROS - 2 BRAÇOS 1 - 1/8" (19-55MM)	0.10	12	72	1728	12,00€
52592	POLIDORA DE CILINDROS - 3 BRAÇOS 2" (35-85MM)	0.20	-	20	480	22,00€
52593	POLIDORA DE CILINDROS - 3 BRAÇOS 4" (55-170MM)	0.47	6	36	432	34,00€

52591



REPOSIÇÕES
DISPONÍVEIS



52592



REPOSIÇÕES
DISPONÍVEIS



52593



REPOSIÇÕES
DISPONÍVEIS



ALICATES PARA ANÉIS DE PISTÃO

REF.	DESCRIÇÃO					€
54273	ALICATES PARA ANÉIS DE PISTÃO 40-100MM	0.30	6	30	-	11,90€
54274	ALICATES PARA ANÉIS DE PISTÃO 80-120MM	0.35	6	30	-	12,90€
54275	ALICATES PARA ANÉIS DE PISTÃO 100-160MM	0.40	6	30	-	15,30€



54273



54274



54275



52696 12,00€

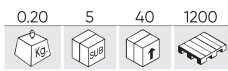

COMPRESSOR AROS PISTÃO 3"



52697 16,00€

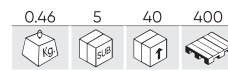

COMPRESSOR AROS PISTÃO 6"



53251 94,00€



KIT DE FERRAMENTAS PARA AROS DE PISTÃO

A	x1	H:3" Ø 53 - 125mm	E	x1	1.2 - 5.5mm
B	x1	H:4" Ø 90 - 175mm	F	x1	PH2, SL5.5
C	x1	H:6" Ø 90 - 175mm	G	x2	6 in 1
D	x1	50 - 100mm	H	x3	6mm



53662 89,00€

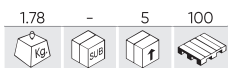

COMPROVADOR DE FUGA PARA JUNTAS DE CILINDROS

Peças	9
Capacidade	200-250ml
Adaptadores	Pequeno/Small, Mediano/Medium, Grande/Large
Marcas	Multimarca/Multi-brand
Peso	1,78Kg
Dimensões (CxLxA)	400x260x75mm



VÍDEO TUTORIAL



REPOSIÇÕES DISPONÍVEIS

54347 49,00€



VERIFICADOR DE FUGAS DE CILINDROS

Peças	4
Adaptadores	M10x1.0, M12x25, M14x1.2
Entrada de ar	1/4"
Pressão do trabalho	6,5BAR
Peso	2,00Kg
Dimensões (CxLxA)	340x80x240mm



52754

54,00€



MEDIDOR DE PRESSÃO DE ÓLEO

x1	M10x1.0mm	x1	1/8" DIN 2999
x1	M12x1.5mm	x1	1/8" x 27 NPT
x1	M14x1.5mm	x1	1/4" x 18 NPT
x1	M16x1.5mm	x1	3/8" x 20 UNF
x1	M18x1.5mm	x1	1/2" x 20 UNF

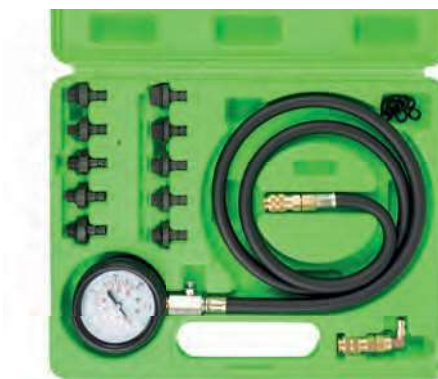

52076

111,00€

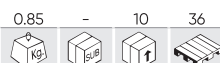

KIT PARA REPARAR ROSCAS DE VELAS DIESEL

x2	Instalação de casquilho	x1	Barra de instalação de casquilho
x1	Pega para varilha	x1	M14x1.25
x5	M8x1.0	x1	M12x1.25
x5	M10x1.0	x1	M12x1.0
x5	M10x1.25	x1	M10x1.25
x5	M12x1.25	x1	M10x1.0
x3	Bujão c/ extremidades s/rosc	x1	M8x1.0



REPOSIÇÕES DISPONÍVEIS

52815

110,00€



KIT EXTRATOR DE VELAS INCANDESCENTES

x2	M8x1.0	x1	ø2.5x120mmL
x2	M10x1.0	x1	ø3.3x140mmL
x2	M10x1.25	x1	M3x0.5x100mmL
x1	M8x1.0	x1	M4x0.7x100mmL
x1	M10x1.0	x1	M3x0.5x180mmL
x1	M10x1.25	x2	M4x0.7x180mmL
x1	M8x1.0	x3	
x1	M10x1.0		
x1	M10x1.25		



52305

106,00€



KIT REPARADOR DE VELAS DE AQUECIMENTO

x2	M8x1.0	x1	ø2.5x120mmL
x2	M10x1.0	x1	ø3.3x140mmL
x2	M10x1.25	x1	M3x0.5x100mmL
x1	M8x1.0	x1	M4x0.7x100mmL
x1	M10x1.0	x1	M3x0.5x180mmL
x1	M10x1.25	x2	M4x0.7x180mmL
x1	M10x1.25		



52832 75,00€

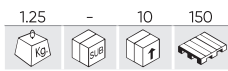

JOGO DE CHAVES CURVADAS PARA EXTRAÇÃO DE CORREIAS 12 CANTOS CABEÇA INTERCAMBIÁVEL



A	x8	12, 13, 14, 15, 16, 17, 18, 19mm
B	x1	450mm
C	x1	50mm

52690 54,00€

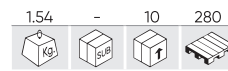

ALAVANCA PARA AFROUXAR CORREIAS

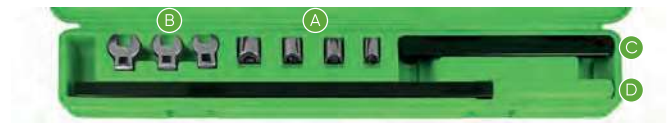

A	x4	13, 15, 16, 18mm
B	x3	13, 14, 15mm
C	x1	1/2" 230mm
D	x1	3/8" 585mm

53637 85,00€

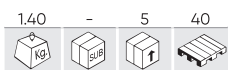

ORGANIZADOR PARA COMPONENTES DO MOTOR ESPECIAL PARA PEÇAS DE CABEÇOTES



Peças	1
Peso	1,40Kg
Dimensões (CxLxA)	450x400x104mm

52850 7,80€

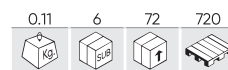

2PCS FERRAMENTA PARA RODAR VÁLVULAS



Peças	2
Diâmetro	3,49-2,86mm/1,59-2,06mm
Peso	0,11Kg

53572 348,00€

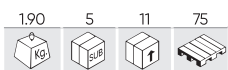

FERRAMENTA PNEUMÁTICA PARA POLIMENTO DE VÁLVULAS - PERCUSSÃO E ROTAÇÃO

Peças	12
RPM (rotações por minuto)	800
Entrada de ar	1/4"
Consumo real de ar	1,80CFM (51L/min)
Peso	1,90Kg
Dimensões (CxLxA)	283x87x70mm



REPOSIÇÕES DISPONÍVEIS



54033 49,00€

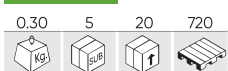

FERRAMENTA PARA BERBEQUIM - RODA VÁLVULAS

Peças	6
Diâmetro	16, 20, 30, 35, 40mm
RPM (rotações por minuto)	1250
Peso	0,30Kg
Comprimento	128mm



REPOSIÇÕES DISPONÍVEIS



53249

192,00€

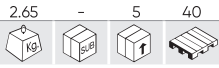

ESTETOSCÓPIO ELECTRÔNICO

Peças	11
Comprimento da sonda de áudio	140mm
Bateria	9V
Quantidade de sensores	6
Adequado para conectores	3,5mm
Comprimento ajustável do microfone	210mm
Comprimento do cabo do sensor	4,8m
Peso	2,65Kg
Dimensões (CxLxA)	410x360x110mm



51347

9,90€



ESTETOSCÓPIO



Comprimento do cabo	910mm
Ponta/ Comprimento da sonda	320mm
Peso	0,15Kg

52190

8,00€

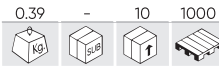

CHAVE DE EMBREAGEM ESPECIAL FIAT



Marcas	FIAT
Peso	0,39Kg
Dimensões (CxX)	220x110mm

52495

14,50€

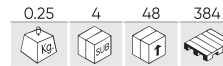

CENTRALIZADOR EMBREAGENS UNIVERSAL (PLÁSTICO)



Marcas	Multimarca/Multi-brand
Adaptadores	3
Peso	0,25Kg

53410

92,00€

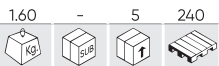

CENTRALIZADOR DE EMBREAGEM SAC



Peças	11
Marcas	Multi-marca/Multi-brand
Peso	1,60Kg
Dimensões (CxLxA)	275x60x215mm

53057

149,00€

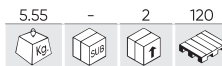

KIT DE REPARAÇÃO DO EMBREAGEM DUPLA FACE PARA LA TRANSMISSÃO DSG DE VAG



Peças	5
Compatível com	GOLF (2004), GOLF PLUS (2005), AUDI A3 (2004), TOUAREG (2003)
Peso	5,55Kg
Dimensões (CxLxA)	315x200x110mm

53001



KIT CENTRADOR DE EMBREAGEM SAC

- x1 Tensor de Embreagem
- x1 Centralizador de 3 braços
- x1 Ferramenta para repor parâmetros de origem
- x1 Jogo de pinos centralizadores
- x1 Centralizador de 4 braços

242,00€



50731



REFRATÔMETRO PARA ÁLCOOL



68,00€

Peças	3
Peso	0,55Kg
Dimensões (CxLxA)	245x80x55mm

52963

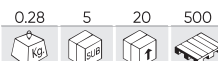

REFRATÔMETRO UNIVERSAL



49,00€

Peças	4
Peso	0,28Kg
Dimensões (CxLxA)	205x85x55mm

54591



DISPOSITIVO DE TESTE DA BOMBA DA ÁGUA



58,00€

Peças	8
Peso	1,43Kg
Dimensões (CxLxA)	350x25x65mm

53477

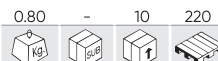

KIT DE 8 PINÇAS PARA A DESCONEXÃO DE MANGUEIRAS



39,50€

Peças	8
Diâmetro	8, 10, 13mm
Peso	0,80Kg
Dimensões (CxLxA)	265x210x60mm

52066

12,00€

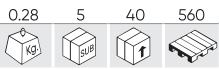

KIT DE ALICATES PARA MANGUEIRAS FLEXIVEIS

A	x1	0-70mm
B	x1	0-35mm
C	x1	0-20mm

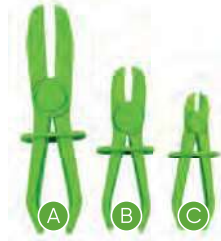

53395

16,00€

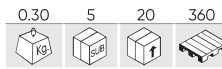

KIT DE ALICATES PARA MANGUEIRAS FLEXIVEIS

A	x1	35mm
B	x1	20mm
C	x1	13mm

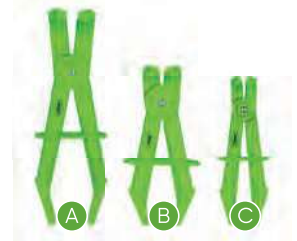

52687

168,00€

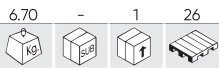

COMPROVADOR DE VAZAMENTO DE PRESSÃO PARA SISTEMA DE REFRIGERAÇÃO

- 1 Bomba de pressão com válvula de descarga
- 2A Conector 1: acoplador para os cabeçóis No.3(R123) e No.4 (R124)
- 2B Conector 2: acoplador para os cabeçóis No. 3(R123) y No. 5(R125)
- 3 Mercedes (W123, W126, W124, W201), GM(Buick), Jeep
- 4 Peugeot, Subaru, Chrysler, Acura, GM, Mitsubishi, Nissan, Mazda, Toyota, Infiniti, GEO, Suzuki, Isuzu, Mercedes
- 5 Honda, Toyota, Suzuki, Mitsubishi, Chrysler, Acura
- 6 Mercedes Benz (ML, W163, W164), GM (Acliva, Skylark, Grand Am 1992~2002)
- 7 Volvo, Saab, Sterling, Citroën, Renault, Fiat, Alfa, Jeep
- 8 VW(Vento, T4, Passat-1996, Golf, Beetle, Sharan)
- 9 Audi(A4, A5, A6), BMW 345, VW (Passat - 1997~2002), Porsche(Cayenne)
- 10 BMW (E46, E36, E34, E39, E38, E32, E90)
- 11 Audi, VW
- 12 Internacional, Land Rover, Jaguar
- 13 Mercedes (C, E, S, W140, W220, W124, W210, W211, W215, W216, W221, R230)
- 14 Ford Focus
- 15 Mazda(M3)
- 16 Mercedes classe A (W168)
- 17 BMW E60, E63, E64, E65
- 18 VW SHARAN 1.8T 2.8
- 19 TOYOTA-RAV4, PREVIA Adaptador universal de goma para purga e enchimento adores
- 20 SAAB
- 21 LAND ROVER
- 22 Kia
- 23 Hunday



54139

147,00€



KIT UNIVERSAL DE TESTE DE PRESSÃO DO SISTEMA DE REFRIGERAÇÃO (5 PÇS)



Peças	5
Pressão do trabalho	0-2,5BAR
Peso	3,15Kg
Dimensões (CxLxA)	445x90x290mm

53453

7,00€

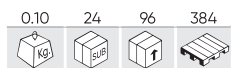

COMPROVADOR DE ANTICONGELANTE



54368

2.329,00€

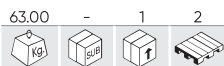

MÁQUINA DE LIMPEZA DO SISTEMA DE REFRIGERAÇÃO

Alimentação	DC12V
Manômetro	0-2BAR
Comprimento da mangueira de saída do refrigerante	2500mm
Comprimento da mangueira de retorno do refrigerante	2500mm
Capacidade do novo reservatório de refrigerante	20L
Tamanho do reservatório usado de refrigerante	20L
Tela	7"
Peso	50,00Kg
Dimensões (CxLxA)	690x590x1140mm



VÍDEO TUTORIAL



REPOSIÇÕES DISPONÍVEIS



54565

2.268,00€



MÁQUINA DE MUDANÇA DE LÍQUIDO DE REFRIGERAÇÃO

Faixa de pressurização do tanque novo	0,85-1,5BAR
Capacidade máxima de vácuo	-20InHg
Volume recomendado de líquido de refrigeração novo	12L
Comprimento da mangueira de aspiração	2,7m
Pressão do trabalho	5-10BAR
Peso	43,00Kg
Dimensões (CxLxA)	630x480x1340mm



VÍDEO TUTORIAL



REPOSIÇÕES DISPONÍVEIS



54291

5.054,00€

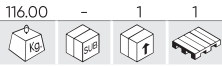

ESTAÇÃO DE CARGA PARA AR CONDICIONADO

Potência do compressor	3-8HP
Capacidade do compressor	12cm ³
Potência da bomba de vácuo	180W
Velocidade de recuperação do refrigerante	450-800g/min Líquido/Liquid
Percentagem de recuperação	99%
Velocidade de carga do refrigerante	>2Kg/min
Capacidade da bomba de vácuo	100L/min
Capacidade do tanque de refrigerante	12L
Capacidade de óleo novo	280ml
Capacidade de óleo usado	500ml
Temperatura de trabalho	10/50°C
Pressão do trabalho	20BAR
Tela	240x118mm
Alimentação	220V+-10%, 50/60Hz
Tipo de refrigerante	R134A/R1234YF
Peso	116,00Kg
Dimensões (CxLxA)	690x770x1306mm



VÍDEO TUTORIAL



REPOSIÇÕES DISPONÍVEIS

16309

149,00€

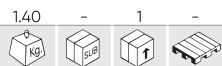

KIT DE 2 TUBOS DE ALTA E BAIXA PRESSÃO COM 5 METROS DE COMPRIMENTO (REF.54291)



53499

29,00€

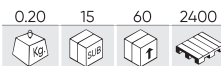

ADAPTADOR PARA CARGA DE GÁS 1234YF (ALTA)



53500

29,00€

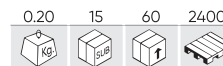

ADAPTADOR PARA CARGA DE GÁS 1234YF (BAIXA)



53539

66,00€

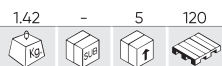

KIT DETECÇÃO FUGA AA/CC

- x1 Lâmpada UV 100Lm
- x1 Óculos de visão UV
- x1 Seringa inserção líquido
- x1 Adaptador rápido
- x1 Adaptador de extensão
- x1 Pila recargável
- x1 Carregador



REPOSIÇÕES DISPONÍVEIS

53456

98,00€

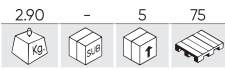

KIT DE COMPROVAÇÃO, ENCHIMENTO E ESAZIAMENTO DE SISTEMA AACC (BAR)

Peças	9
Rosca de união	7/16x20UNF
Pressão do trabalho	0-24, 0-34BAR
Comprimento da mangueira de alta capacidade	1550mm
Peso	2,90Kg
Dimensões (CxLxA)	305x305x95mm



REPOSIÇÕES DISPONÍVEIS



16316

18,50€

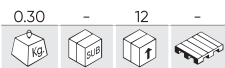

ÓLEO UNIVERSAL PAG PARA AR CONDICIONADO 250ML



Capacidade	250ml
Temperatura de trabalho	-30/50°C
Peso	0,30Kg
Dimensões (CxLxA)	50x50x160mm

12977

36,50€

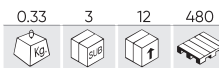

LÍQUIDO DETECÇÃO FUGA SISTEMA AACC 250ML



Capacidade	250ml
Peso	0,33Kg
Dimensões (CxLxA)	175x100x55mm

54523

26,50€



KIT PARA REMOÇÃO DA EMBREAGEM DO COMPRESSOR DO A/C

Peças	12
Peso	1,95Kg
Dimensões (CxLxA)	310x250x55mm



54536

152,00€

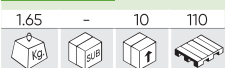

ENDOSCÓPIO PARA LIMPEZA DE AR CONDICIONADO



VÍDEO TUTORIAL



50807

38,00€

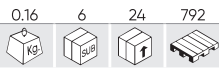

KIT DE O'RINGS PARA AACC



53599

31,00€



KIT DE VÁLVULAS PARA O AR CONDICIONADO



53459

66,00€

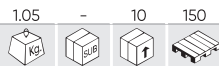

KIT PARA A DESCONEXÃO DO AR CONDICIONADO



Diâmetro das braçadeiras

x6 8mm (5/16"), 9,5mm (3/8"), 13mm (1/2"), 16mm (5/8"), 19mm (3/4"), 22mm (7/8")

Diâmetro do bloqueador

x4 9,5 mm (3/8"), 16mm (5/8"), 13mm (1/2"), 19mm (3/4")

53638

243,00€

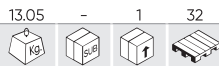

EXTRATOR HIDRÁULICO DE BUCHAS DA RODA

Peças	8
Comprimento	570mm
Marcas	Multimarca/Multi-brand
Peso	13,35Kg
Dimensões (CxLxA)	590x360x130mm



REPOSIÇÕES DISPONÍVEIS



54069

31,00€

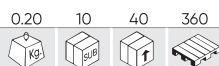

KIT DE FERRAMENTAS DE LIMPEZA DE BUCHAS, 14 PÇS

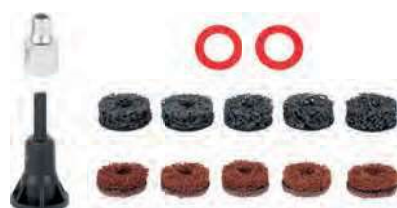

Peças	14
Adaptadores	8mm
Peso	0,20Kg

54749

54,00€

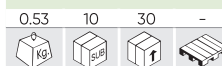

KIT DE LIMPEZA DE PERNOS E CUBOS



REPOSIÇÕES DISPONÍVEIS



Peças	7
Adaptadores	50x12, 50x13, 50x14, 60x16, 60x22, 60x28mm
Peso	0,54Kg

54384

33,00€

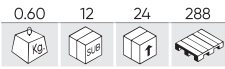

LIMPADOR DE CUBOS DE RODA



REPOSIÇÕES
DISPONÍVEIS



Peças	2
Diâmetro exterior	150mm
Diâmetro interior	90mm
Velocidade máxima de varredura	1500RPM
Diâmetro do eixo	1/2"
Peso	0,60Kg

51364

26,00€

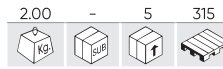

EXTRATOR DE JUNTAS HOMOCINÉTICAS



Largura	45mm
Comprimento máximo	240mm
Comprimento mínimo	140mm
Peso	2,00Kg

52829

19,00€

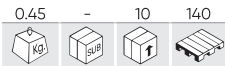

FERRAMENTA P/MONTAR FOLE DE TRANSMISSÕES



Diâmetro exterior	100mm
Diâmetro interior	95mm
Peso	0,45Kg
Comprimento	410mm

51121

27,30€

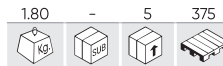

KIT DE COMPRESSOR DE MOLAS



Peças	2
Capacidade	1T
Abertura	250mm
Peso	1,80Kg

52639

123,00€

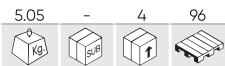

KIT PARA BRAZOS DIREÇÃO



	x3	Ø 30-35, 34-40, 40-45mm
	x1	1/2"
	x1	3mm

52541

45,00€

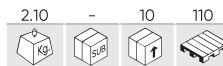

COMPROVADOR DE EIXOS



Peso	2,10Kg
Dimensões (CxLxA)	550x420x60mm

51902

84,00€

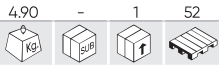

ALAVANCA DE EXTRAÇÃO DE RÓTULAS DE SUSPENSÃO COM ARTICULAÇÃO ESFÉRICA



REPOSIÇÕES DISPONÍVEIS

Comprimento	1180mm
Tubo	35mm
Peso	4,90Kg
Dimensões (CxLxA)	118x330x60mm

51991

68,00€

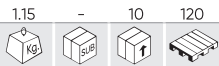

ALINHADOR DE DIREÇÃO



Peças	2
Abertura	1100-1950mm
Material	Al, Fe
Peso	1,15Kg
Dimensões (CxLxA)	1105x225x30mm

50827

387,00€

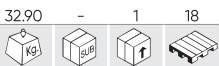

COMPRESSOR DE MOLAS PARA AMORTECEDORES

Capacidade	1T
Diâmetro da mola	200mm
Altura máxima	500mm
Peso	35,00Kg
Dimensões (CxLxA)	350x190x830mm



REPOSIÇÕES DISPONÍVEIS

53118

231,00€

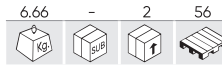

KIT PARA REMOÇÃO DE AMORTECEDOR



Peças	39
Material	CRV 6140, CRMO SCM415, CRV 50BV30
Peso	6,66Kg
Dimensões (CxLxA)	575x451x75mm



53742

1.325,00€

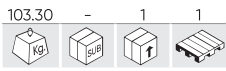

COMPRESSOR DE MOLA DE AMORTECEDOR PNEUMÁTICO 1T

Capacidade	1T
Comprimento máximo de trabalho	450mm
Comprimento do curso do cilindro	420mm
Diâmetro da mola	102-165mm
Pressão de ar máxima	9BAR
Dimensões (CxLxA)	690x560x1410mm
Peso	62,00Kg



VÍDEO TUTORIAL

53394

598,00€

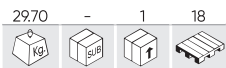

COMPRESSOR DE MOLAS UNIVERSAL HEAVY DUTY



Peças	7
Carga máxima	10.200Nm
Peso	29,70Kg
Dimensões (CxLxA)	690x470x145mm

ADEQUADO PARA USO COM FERRAMENTAS PNEUMÁTICAS

52227

247,00€



KIT COMPRESSOR DE MOLAS MCPHERSON



Peças	8
Carga máxima	2500Nm
Peso	15,10Kg
Dimensões (CxLxA)	530x445x130mm

NÃO USAR COM PISTOLA NEUMÁTICA

52270

117,00€

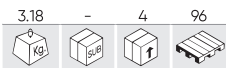

EXTRATOR DE CASQUILHOS PARA VAG

Peças	8
Material	Acero al carbono/Carbon steel, Aleación de aluminio/Aluminum alloy
Peso	3,18Kg
Dimensões (CxLxA)	330x245x92mm



52432

35,00€

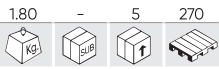

EXTRATOR DE CASQUILHOS FRONTAIS PARA VAG

Compatível com	VW POLO 2002
Peso	1,80Kg
Dimensões (CxLxA)	400x100x70mm



EXTRATOR

REF.	DESCRIÇÃO					€
51368	CHAVE UNIVERSAL DE BARRA DE DIREÇÃO INTERNA	0.41	5	50	2700	19,00€
51369	EXTRATOR DE PORCAS FÊMEAS AXIAIS	0.55	6	36	2016	28,00€
51414	EXTRATOR DE PERNOS	0.59	5	40	1440	14,00€



51368



51369



51414

EXTRATOR PARA BRAÇO DE DIREÇÃO

REF.	DESCRIÇÃO					€
52640	EXTRATOR PARA BRAÇO DE DIREÇÃO Ø 28-35MM	1.80	-	4	256	52,00€
52641	EXTRATOR PARA BRAÇO DIREÇÃO Ø 35-45MM	2.20	-	4	148	55,00€



52640



52641

EXTRATOR PARA BRAÇO DE DIREÇÃO

REF.	DESCRIÇÃO					€
52874	EXTRATOR PARA BRAÇO DE DIREÇÃO Ø 9-20MM	1.20	4	20	1500	85,00€
52875	EXTRATOR PARA BRAÇO DE DIREÇÃO Ø 14-23MM	1.25	5	20	1500	88,00€



52874



52875

53635

91,00€

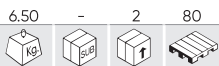

EXTRATOR DE ROLAMENTOS COM PLACA DESLIZANTE

Diâmetro	100-115mm
Comprimento	630mm
Peso	6,50Kg



54560

18,40€

0.16 10 40 2000



FERRAMENTA DILATADORA DE ESCORAS DE SUSPENSÃO



Abertura	5-11,5mm
Peso	0,16Kg
Dimensões (CxLxA)	310x270x195mm

54595

18,50€

0.65 10 50 -



FERRAMENTA DE ESPALHAMENTO DO SUPORTE DE SUSPENSÃO



Abertura	5-30mm
Peso	0,65Kg
Dimensões (CxLxA)	85x32x40mm

52642

32,00€

1.32 5 10 720



EXTRACTOR DE JUNTAS ESFÉRICAS UNIVERSAIS



Peças	1
Abertura	55-60mm
Diâmetro	17-22mm
Peso	1,32Kg

52699

22,00€

0.80 5 30 1350



EXTRACTOR DE JUNTAS ESFÉRICAS AJUSTÁVEL



Peças	1
Abertura	15-55mm
Diâmetro	18-22mm
Peso	0,80Kg



51123

91,00€

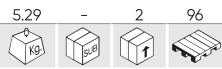

JOGO 5 EXTRATORES DE RÓTULA



	A	B	C	D	E
Abertura	18mm	33mm	250mm	18mm	22mm
Abertura (dentro)	45mm	55mm	0mm	25mm	20mm
Dimensões	50x18mm	55x28mm	160x75x16mm	50x28 mm	80x43x45mm
Dirigir	19mm	19mm	17mm	19mm	21mm
Fuso	M16x1,5	M16x1,5	14mm	M12x1,75	M16x1,5

53384

173,00€

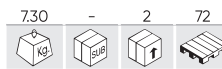

EXTRATOR DE RÓTULAS HIDRÁULICO



REPOSIÇÕES DISPONÍVEIS



Peças	5
Capacidade	10T
Abertura	100mm
Largura	35mm
Passo da rosca do fuso hidráulico	11/2"
Peso	7,30Kg

54513

75,00€

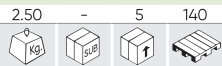

CONJUNTO DE 5 EXTRATORES DE RÓTULA DE GARFO PARA MARTELO PNEUMÁTICO



REPOSIÇÕES DISPONÍVEIS



x5 20, 24, 30, 35, 42mm

51490

36,00€

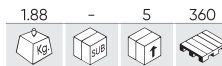

KIT DE EXTRATORES DE RÓTULAS



x1	Cabo para usar com um martelo
x1	Cabo desenhado para utilizarse com um martelo pneumático
x3	Forquilhas: 11/16, 15/16" e 1-1/8"

53488

66,00€

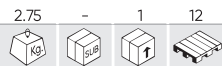

ALINHADOR DE QUEDAS (VAG)

x1	75mm	Seat - Toledo VW - Jeta / Golf
x1	85mm	Seat - Cordoba VW - Polo / 95>
x1	115mm	Chrysler - Voyager
x1	22mm	



51119

62,00€

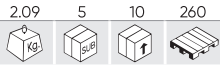

KIT DE 7 PEÇAS PARA SISTEMA DE INJEÇÃO - LAMBDA



- x1 Chave de 1/2" de 29x9 a 90mm de comprimento
- x1 Chave de 1/2" de 7/8" a 50mm de comprimento
- x1 Chave de 1/2" de 27x12 a 78mm de comprimento
- x1 Chave de 3/8" de 7/8" x 6 a 90mm de comprimento
- x1 Chave de 3/8" de 7/8" x 6 a 80mm de comprimento
- x1 Chave de 3/8" de 7/8" a 30mm de comprimento
- x1 Chave de 3/8" de 1" e 1-1/16" a 74mm de comprimento

51491

154,00€



KIT DE 14 PEÇAS PARA O SISTEMA DE INJEÇÃO LAMBDA



- | | | | | | |
|-----------|------|-----------------------------|-----------|-------|--------------------------------------|
| 17mm | 78mm | BMW, Mercedes Benz, Renault | 22mm | 110mm | Audi, BMW, Mercedes Benz, VW, Volvo |
| 19mm | 78mm | VW, Audi, Seat | 22mm | 150mm | BMW |
| 20mm | 80mm | Universal | 27mm | 78mm | Universal |
| 1/2" 21mm | 85mm | Ford, VAG | 1/2" 27mm | 80mm | BMW, Fiat, Ford, Peugeot |
| 22mm | 50mm | Universal | 27mm | 110mm | PSA |
| 22mm | 30mm | Universal | 28mm | 78mm | Volvo, Scania, HGV |
| 22mm | 90mm | Universal | 30mm | 78mm | Bosch, General motors, Mercedes-Benz |

52822

32,00€

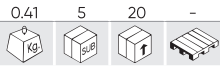

CHAVE PARA SONDA LAMBDA ARTICULADA 22MM



- | | |
|--------------------|-----------------------|
| Medida do quadrado | 22mm |
| Perfil | Hexagonal |
| Tipo | Articulado/Articulate |
| Peso | 0,41Kg |
| Comprimento | 265mm |

52849

8,50€

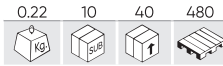

SET DE 2 GANCHOS PARA EXTRAIR BORRACHA DA TUBO DE DESCARGA



- | | |
|-----------------|----------------------|
| Peças | 2 |
| Peso | 0,22Kg |
| Dimensões (CxA) | 215x100mm, 203x100mm |

52637

48,00€

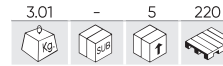

KIT DE EXPANSÃO PARA TUBOS DE ESCAPE



- x1 1-1/8" - 1-3/4"
- x1 1-1/2" - 2-1/2"
- x1 2-1/8" - 3-1/2"

51259

58,00€

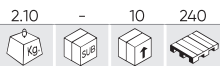

KIT DE EXTRAÇÃO DE POLIAS 18 PEÇAS

- | | | |
|---|----|---|
| A | x3 | T50x110mm (1/2"), M10x110 (1/2"), M10x90mm (3/8") |
| B | x1 | M10x140mm |
| C | x2 | 19, 22mm |
| D | x3 | 22x28, 19x28, 21x28mm |
| E | x1 | 1/2"x10mm |
| F | x1 | M10x65mm |
| G | x6 | T40, T50, M8, M10, H8, H10 (10x75mm) |
| H | x1 | H22 |



REPOSIÇÕES DISPONÍVEIS

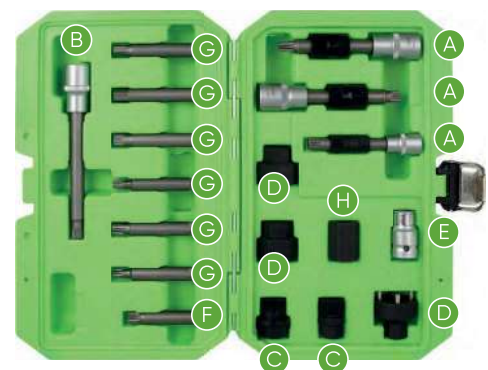

52293

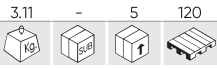

KIT DE EXTRAÇÃO DE POLIAS DE 30 PEÇAS

1	1/2" x T50 - 33 Teeth	16	especial
2	1/2" x M10 - 33 Teeth	17	1/2" x M10
3	H15 x 33 Teeth	18	3/8" x M10 - 31 Teeth
4	H22 x 33 Teeth	19	Especial
5	H22	20	Especial
6	H17 x 4 Pin	21	Especial
7	1/2" x H10	22	Especial
8	H8 x H10	23	M10 x H12
9	H10 x H10	24	T50 x H12
10	M8 x H10	25	Especial
11	M10 x H10	26	Especial
12	T40 x H10	27	3/8" x 10mm
13	T50 x H10	28	1/2" x T50
14	H10 x FH10	29	1/2" x T50
15	Especial	30	1/2" x M10

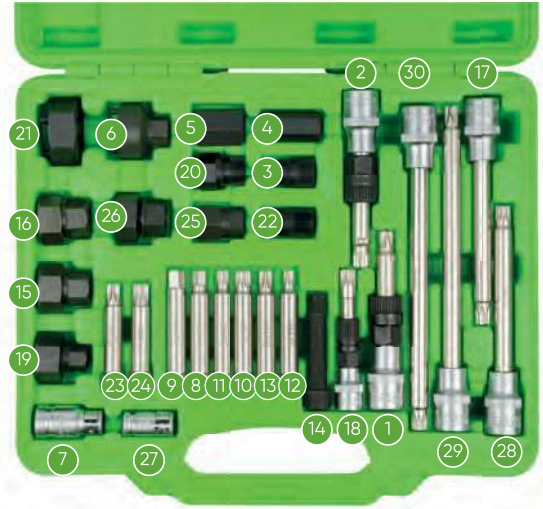

51495

59,00€

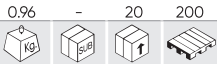

EXTRATOR DE BOBINA DE IGNIÇÃO PARA VW



Peças	4
Peso	0,96Kg
Dimensões (CxLxA)	215x210x170mm

52621

11,00€

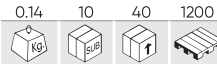

LIMPADOR DE TERMINAIS DE BATERIA



Peças	2
Medidas	80x38,5mm
Peso	0,14Kg

52319

8,80€

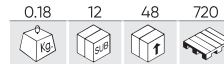

LIMPADOR DE TERMINAIS DE BATERIA



Peças	1
Medidas	122, 107mm
Peso	0,13Kg

EXTRATOR DE CONEXÕES DE AQUECEDOR

REF.	DESCRIÇÃO	kg	box	box	box	€
52816	EXTRATOR DE CONEXÕES DE AQUECEDOR - BOCA EM ÂNGULO - 235MM	0,27	6	36	-	30,00€
52817	EXTRATOR DE CONEXÃO DE AQUECEDOR- BOCA RETO 250MM	0,28	6	36	-	28,50€



52816



52817



CHAVE DE VELA MAGNÉTICA

REF.	mm					€
52316	Ø14mm	0.20	12	48	2880	18,90€
52317	Ø 16mm	0.30	12	48	2880	1990€



CHAVE DE VELAS HEX.

REF.	mm					€
10054	1/2" - 16mm	0.08	10	100	-	2,90€
10055	1/2" - 21mm	0.14	10	100	-	3,90€



52691

54,00€



CHAVE DE VELA ARTICULADA

3/8"	8mm (82mm)
3/8"	9mm (82mm)
3/8"	10mm (82mm)
3/8"	12mm (82mm)
3/8"	14mm (82mm)
3/8"	16mm (82mm)

COM FIXAÇÃO MECÂNICA



CHAVE DE VELA MAGNÉTICA

REF.	mm					€
54381	14mm	0.35	10	40	840	5,20€
54382	16mm	0.35	10	40	840	5,20€
54383	21mm	0.35	10	40	840	5,20€



51501

38,00€

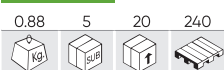

KIT PARA EXTRAÇÃO DE AIRBAGS



	T25 (BMW)
	T30 (AUDI, OPEL, RENAULT, VW)
	T25 (BMW)
	T30 (AUDI, OPEL, RENAULT, VW)
	5mm (AUDI)
	5-1/4"x 87mm (L)

53388

94,00€



TRUSĂ DE 52 PEÇAS PARA EXTRAÇÃO DE EQUIPAMENTOS DE AUDIO



51126

18,00€

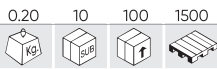

KIT DE ACESSÓRIOS PRA EXTRAIR EQUIPAMENTOS ÁUDIO



Peças	10
Peso	0,20Kg
Dimensões (CxLxA)	125x76x50mm

51986

11,90€

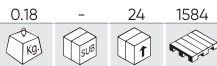

RECÂMBIO DE GAS 200ML



Capacidade	200ml
Peso	0,18Kg
Dimensões (CxLxA)	17,2x50x50mm

51920

18,00€

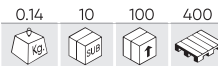

MAÇARICO



Peso	0,15Kg
Dimensões (CxLxA)	220x165x75mm

53663

8,00€

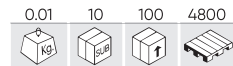

FERRAMENTA DE DESMONTAGEM DE CONECTORES PARA VAG



Peso	0,10Kg
Dimensões (CxLxA)	140x15x100mm

53393

118,00€

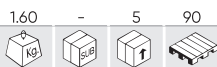

KIT DE 23 EXTRATORES DE TERMINAIS



Peças	23
Peso	1,60Kg
Dimensões (CxLxA)	435x250x70mm

53391

92,00€

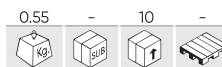

KIT DE 19 EXTRATORES DE TERMINAIS

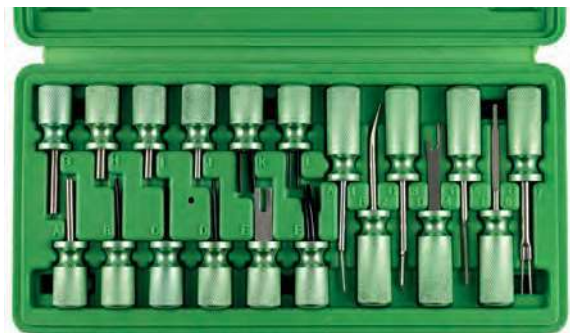

Peças	19
Peso	0,55Kg
Dimensões (CxLxA)	245x125x40mm

53474 94,00€

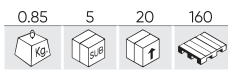

PISTOLA ESTROBOSCÓPICA DIGITAL



Tensão	12V
Potência	3.6W
Precisão	0,1°
Velocidade máxima de rotação	9000RPM
Comprimento do cabo	1800mm

53240 58,00€

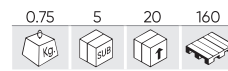

PISTOLA ESTROBOSCÓPICA



Tensão	12V
Potência	3.6W
Precisão	1°
Velocidade máxima de rotação	10000RPM
Comprimento do cabo	1500mm

KIT REPARADOR DE ROSCAS HELICÓIDAI

REF.	DESCRIÇÃO					€
53041	KIT REPARADOR DE ROSCAS HELICÓIDAI M14X1,25	0.54	-	10	1000	37,60€
51898	KIT REPARADOR DE ROSCAS HELICÓIDAI M18X2,5	1.81	-	4	252	139,00€
51899	KIT REPARADOR DE ROSCAS HELICÓIDAI M20X2,5	2.12	-	4	252	147,00€



53041



51898 - 51899



51898
REPOSIÇÕES
DISPONÍVEIS



51899
REPOSIÇÕES
DISPONÍVEIS

51896 82,00€



KIT REPARADOR DE ROSCAS HELICÓIDAI



REPOSIÇÕES
DISPONÍVEIS

CONTÉM POR MEDIDA	CONTÉM
Broca	25 x M5x0.8
Macho de roscar	25 x M6x1
Chave helicoidal	25 x M8x1.25
Punção de ruptura	25 x M10x1.5
Conjunto helicóide aço Inox	10 x M12x1.75

51897 125,00€



KIT REPARADOR DE ROSCAS HELICÓIDAI



REPOSIÇÕES
DISPONÍVEIS

CONTÉM POR MEDIDA	CONTÉM
Broca	9 x M12x1.75
Macho de roscar	9 x M14x2
Chave helicoidal	9 x M16x 2.0
Punção de ruptura	
Conjunto helicóide aço Inox	

50793

94,00€

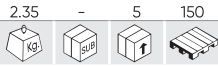

KIT FERR. CORTE 60 P. MACHOS E CAÇONETES. MÉTRICO E PULGADA



- x1 NPT macho (pol.): 1/8-27.
- x1 NPT caçonete (pol.): 1/8-27.
- x1 Porta Macho misto tip: M3 ~ M12 e 3/16 "a 1/2".
- x1 Porta Macho misto tip: M3 ~ M6 ~ 6-32 e 4-40
- x1 Porta caçonetes misto: Ø25mm
- x1 Chave de fenda
- x1 Jogo de galgas métricas para roscar.
- x1 Jogo de galgas métricas para roscar.
- x10 Machos (métricos): M3X0.5, M4x0.7, M5x0.8, M6x1.0, M7x1.0, M8x1.25, M9x1.25, M10x1.0, M10x1.5, M12x1.75.
- x10 Machos UNC (pulgadas): 4-40, 10-24 6-32, 8-32, 12-24, 1/4-20, 5/16-18, 3/8-16, 7/16-14, 1/2-13.
- x6 Caçonetes UNF (pulgadas): 10-32, 1/4 -28, 5/16-24, 3/8-24, 7/16-20, 1/2-20.
- x10 Caçonetes (métricos): M3x0.5, M4x0.7, M5x0.8, M6x1.0, M7x1.0, M8x1.25, M9x1.25, M10x1.0, M10x1.5, M12x1.75.
- Caçonetes UNC (pulgadas): 4-40, 10-24 6-32, 8-32, 12-24, 1/4-20, 5/16-18, 3/8-16, 7/16-14, 1/2-13.
- x6 Caçonetes UNF (pulgadas): 10-32, 1/4-28, 5/16-24, 3/8-24, 7/16-20, 1/2-20.

54280

175,00€

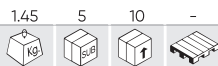

KIT DE REPARACIÓN DE ROSCAS DE BUJÍAS



REPOSIÇÕES DISPONÍVEIS



Peças	7
Peso	1,45Kg
Dimensões (CxLxA)	325x105x55mm

50792

105,00€



KIT FERR CORTE 58P. MACHOS E CAÇONETES RECOBERTAS DE TITÂNIO



- x1 Macho e 1 caçonete tipo NPT: 1/8-27.
- x1 Macho e 1 caçonete tipo TPN: 1/8-27.
- x1 Porta Macho: M4 ~ M12.
- x1 Porta Machos tipo: M3 ~ M6.
- x1 Porta caçonete: 25mm O / D.
- x1 Chave de fenda.
- x1 Jogo de galgas para roscar.
- x34 Machos: M2x0.4 (x2), M3x0.6 (x2), M3x0.5 (x2), M3.5x0.6 (x2), M4x0.75 (x2), M4x0.7 (x2), M5x0.8 (x2), M6x0.75 (x2), M6x1.0 (x2), M7x0.75 (x2), M7x1.0 (x2), M8x1.0 (x2), M8x1.25 (x2), M10x1.25 (x2), M10x1.5 (x2), M12x1.25 (x2), M12x1.75 (x2)
- x17 Caçonetes: M2x0.4, M3x0.6, M3x0.5, M3.5x0.6, M4x0.75, M4x0.7, M5x0.8, M6x0.75, M6x1.0, M7x0.75, M7x1.0, M8x1.0, M8x1.25, M10x1.25, M10x1.5, M12x1.25, M12x1.75

54003

110,00€

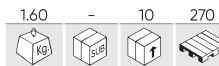

KIT DE REPARAÇÃO DE ROSCAS INTERNAS E EXTERNAS



Peças	9
Peso	1,60Kg
Dimensões (CxLxA)	250x200x65mm

53652 56,00€

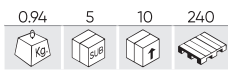

KIT DE REPARAÇÃO DE ROSCA PARA PINOS DE RODA



REPOSIÇÕES DISPONÍVEIS



Peças	8
Peso	0,94Kg
Dimensões (CxLxA)	260x160x60mm

53055 33,00€

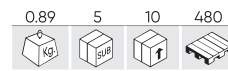

CORTADOR E REBITADOR DE CORRENTE DE MOTOCICLETAS



Peças	11
Peso	0,89Kg
Dimensões (CxLxA)	220x115x55mm

53665 19,00€

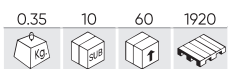

CORTADOR DE CORRENTE DE MOTOCICLETA (25-60)



Faixa	25-60mm
Peso	0,35Kg
Dimensões (CxLxA)	175x90x22mm

53666 28,00€

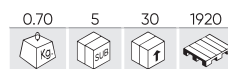

CORTADOR DE CORRENTE DE MOTOCICLETA (60-100)



Faixa	60-100mm
Peso	0,70Kg
Dimensões (CxLxA)	195x110x30mm

53054 6,00€

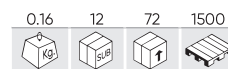

CHAVE ESPECIAL PARA MOTAS



Medidas	19, 22, 24mm
Peso	0,16Kg
Dimensões (CxLxA)	130x70x30mm

53086 9,00€

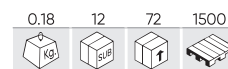

CHAVE PARA MOTAS



Medidas	17, 19, 22, 24mm
Peso	0,18Kg
Dimensões (CxLxA)	170x80x30mm

53701 188,00€

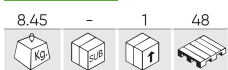

KIT UNIVERSAL DE EXTRATORES DE 2/3 GARRAS



REPOSIÇÕES DISPONÍVEIS



Peças	13
Faixa	45-120mm/50-130mm
Profundidade	165, 275mm
Peso	8,45Kg
Dimensões (CxLxA)	540x363x110mm

EXTRATOR DE 2 GARRAS

REF.	DESCRIÇÃO	—	I					€
52727	EXTRATOR DE 2 GARRAS 25-70MM	25-70mm	50mm	0.20	10	60	1200	34,60€
52728	EXTRATOR DE 2 GARRAS 25-130MM	25-130mm	110mm	1.20	5	10	500	68,00€
52729	EXTRATOR DE 2 GARRAS 60-200MM	60-200mm	160mm	3.26	-	3	240	128,00€
52730	EXTATOR 2 GARRAS 80-350MM	80-350mm	225mm	8.55	-	2	108	288,00€



REF.	DESCRIÇÃO					€
53146	EXPOSITOR DE EXTRATORES	0.70	5	10	140	31,50€

EXTRATOR DE 3 GARRAS

REF.	DESCRIÇÃO	—					€
52731	EXTRATOR DE 3 GARRAS DE 50-100MM	50-100mm	0.90	4	24	504	38,00€
52732	EXTRATOR DE 3 GARRAS 70-150MM	70-150mm	2.54	-	20	300	58,00€
52733	EXTRATOR DE 3 GARRAS DE 95-200MM	95-200mm	5.20	-	4	112	98,00€



EXTRATOR DE 3 GARRAS CONVERSÍVEL EM 2 REVERSÍVEL

REF.	DESCRIÇÃO	T					€
52010	EXTRATOR DE 3 GARRAS CONVERSÍVEL EM 2 REVERSÍVEL 2T	2T	0.50	4	40	360	86,00€
52296	EXTRATOR DE 3 GARRAS CONVERSÍVEL EN 2 REVERSÍVEL 5T	5T	1.57	4	8	120	119,00€
52297	EXTRATOR DE 3 GARRAS CONVERSÍVEL EM 2 REVERSÍVEL 7T	7T	3.33	-	6	36	187,00€
52298	EXTRATOR DE 3 GARRAS CONVERSÍVEL EM 2 REVERSÍVEL , GARRA CURTA E LONGA	2T	2.65	3	6	396	177,00€



51125

88,00€

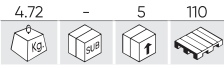

KIT DE EXTRATORES DE GUILHOTINA



x1	Ø50-75mm	x2	3/8" - 16x128mmL
x1	Ø30-50mm	x2	3/8" - 16x104mmL
x1	T16x3x170mmL	x2	3/8" - 16x128mmL
x1	160mmL	x2	3/8" - 16x105mmL

52626

49,00€

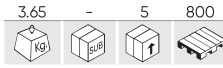

EXTRACTOR DE GUILHOTINA 75-105MM



Peças	3
Abertura	75-105mm
Peso	3,65Kg
Dimensões (CxLxA)	293x172x43mm

52627

120,00€

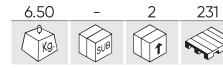

EXTRACTOR DE GUILHOTINA 105-150MM



Peças	3
Abertura	105-150mm
Peso	6,50Kg
Dimensões (CxLxA)	290x290x40mm

53062

99,00€

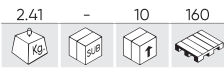

KIT DE EXTRATORES DE ROLAMENTOS COM ESFERAS FALSAS

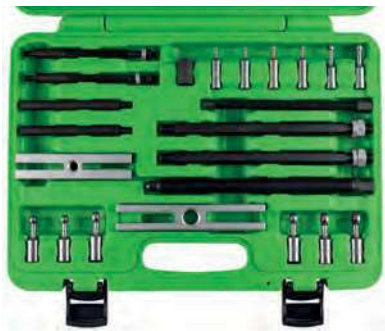

Peças	23
Peso	2,41Kg
Dimensões (CxLxA)	365x265x50mm

54597

125,00€



BASE DE SUPORTE PARA INSERÇÃO I EXTRAÇÃO DE CHUMACEIRAS



Capacidade	20T
Peso	13,00Kg
Dimensões (CxLxA)	300x300mm

52494

227,00€

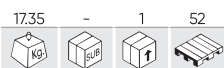

FERRAMENTA UNIVERSAL DE REMOÇÃO / INSTALAÇÃO DE ROLAMENTOS E CASQUILHOS

Medidas	M10, M12, M16, M18
Adaptadores (diâmetro externo/interno)	90/80, 85/75, 82/72, 80/70, 78/68, 76/66, 74/64, 72/62, 70/60, 68/58, 66/56, 64/54, 62/52, 60/50, 58/48, 56/46, 54/44, 52/42, 50/40, 48/38, 46/36, 44/34



REPOSIÇÕES DISPONÍVEIS



51124

88,00€



KIT DE EXTRAÇÃO DE ROLAMENTOS



Peças	5
Peso	3,20Kg
Dimensões (CxLxA)	480x190x58mm

52551

151,00€

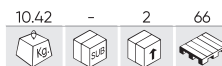

KIT PARA EXTRAÇÃO DE ROLAMENTOS



Peças	20
Peso	10,42Kg
Dimensões (CxLxA)	445x300x90mm

53058

193,00€

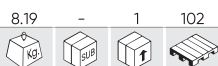

KIT DE MONTAGEM PARA ROLAMENTOS



Peças	51
Peso	8,19Kg
Dimensões (CxLxA)	335x245x90mm

53056

127,00€

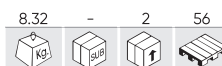

KIT DE EXTRAÇÃO E INSTALAÇÃO DE ROLAMENTOS



Peças	19
Peso	8,33Kg
Dimensões (CxLxA)	535x305x80mm

51349

38,00€



KIT PARA INSTALAÇÃO DE ROLAMENTOS



Peças	17
Peso	1,00Kg
Dimensões (CxLxA)	280x195x65mm

53059

56,00€



KIT DE INSTALAÇÃO DE ROLAMENTOS E FREIOS INTERIORES



Peças	10
Peso	1,70Kg
Dimensões (CxLxA)	255x150x102mm

54299

246,00€

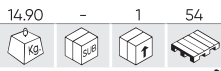

KIT DE REMOÇÃO E INSTALAÇÃO DE BUCHAS DE RODA E ROLAMENTOS

A	Ø 230mm	530mm	860x109mm
		580mm	B 820x100mm
		650mm	710x9,45mm
		660mm	890x176mm
		680mm	C 990x176mm
		710mm	120x178mm
		730mm	D Ø 230mm 950mm
		780mm	E Ø 860mm 955mm
		830mm	F 240x280cm

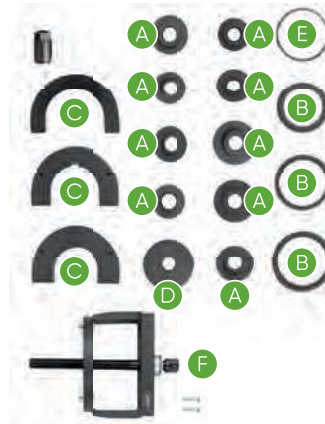

53250

88,00€

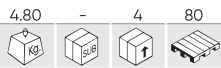

KIT DE EXTRATORES DE ROLAMENTOS INTERNOS E EXTERNOS

A	x1	30-80mm
B	x1	15-30mm
C	x1	15-80mm
D	x1	470x86mm
E	x1	55x22mm



52819

22,00€

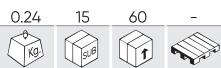

CHAVE 1/2" PARA CAMARA COMBUSTIÃO (MERCEDES)



54419

61,00€

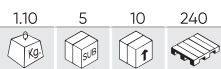

EXTRACTOR/INSTALADOR DO VEDANTE FRONTAL DA EIXO DE MANIVELAS FORD DURATORQ 2.0, 2.2, 2.4, 3.2

MARCAS	FORD: 2.0DI, 2.0 TDCI, 2.0 TDDI, 2.2 TDCI, 2.4 DI, 2.4 TDCI, 3.2 TDCI
FERRAMENTAS OEM	21 238, 303-679A, 303-682
CÓDIGOS DE MOTOR	ABFA, CVFF, CVF5, CVRA, CVRB, CVR5, CYFA, CYFB, CYFC, CYFF, CYFG, CYF4, CYF5, CYRA, CYRB, CYR5, DOFA, DRFA, DRFB, DRFC, DRFE, DRFF, DRFG, DRF4, DRF5, DRRR, DRRB, DRR5, D2FA, D2FB, D3FA, D4FA, D5BA, D6BA, F1FA, FMBA, FMBB, FXFA, F3FA, F4FA, GBVAJQF, GBVAJQJ, GBVAJQW, HJBA, HJBB, HJBC, H9FA, H9FB, H9FD, JXFA, JXFC, N7BA, N7BB, PGFA, PGFB, PHFA, PHFC, P8FA, P8FB, QJBA, QJBB, QJBC, QJBD, QVFA, QWFA, SAFA, SAFB, SA2R, SA2S, SA2W, SDBA, SRFA, SRFB, SRFC, SRFD, SRFE, UHFA, UHFB, UHR5, USF6, USRA, USRB, USR6, UYR6



53875

137,00€



EXTRATOR/INSTALADOR DE CAMBOTA (GRUPO VAG)

MARCAS	VW: GOLF, TOURAN AUDI: A3, A4
FERRAMENTAS OEM	T10134
CÓDIGOS DE MOTOR	1.4I TURBO 1.4 E 1.6 INJEÇÃO DIRETA DE COMBUSTÍVEL 1.9 / 2.0 SDI 2.0 MOTORES DIESEL COMMON RAIL



54460

169,50€



INSTALADOR DO VEDANTE DA CAMBOTA MERCEDES

MARCAS	MERCEDES
FERRAMENTAS OEM	119589011400 651589016100
CÓDIGOS DE MOTOR	M102, M111, M112, M113, M137, M156, M159, M272, M275, M278, M285, OM601, OM602, OM603, OM604, OM605, OM606, OM628, OM629



54457

168,50€



INSTALADOR DO VEDANTE DA CAMBOTA MERCEDES OM 651

MARCAS	MERCEDES
FERRAMENTAS OEM	651589006100 651589016100
CÓDIGOS DE MOTOR	1,8 CDI 2,1 CDI



53129

90,00€



INSTALADOR AJUSTÁVEL DE RETENS 18-90MM



53664

38,00€



EXTRATOR DE POLIAS UNIVERSAL



52624

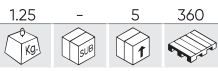

EXTRACTOR DE POLIAS ARMÓNICO

A	x1	Giratória flutuante	E	x2	M8x100mm
B	x1	Ponta rotativa de 3/4"	F	x3	M8x50mm
C	x11	Conjunto de anilhas	G	x2	M6x75mm
D	x1	M16x160mm	H	x3	M6x50mm

28,00€

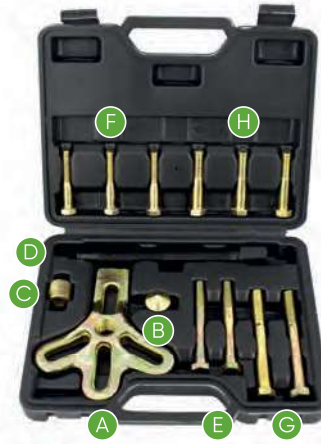

54736

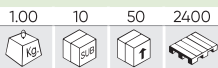

FERRAMENTA DE DESMONTAGEM PARA POLIA DA CAMBOTA PARA FORD



Peças	2
Marcas	FORD
Dimensões (CxLxA)	0,49Kg
Peso	130x370x330mm

22,50€

51500

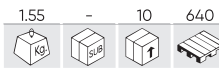

EXTRACTOR DE POLIAS ENCRAVADAS

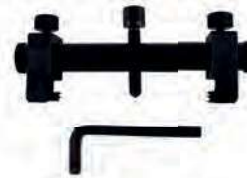

Peças	2
Faixa	40-168mm
Peso	1,55Kg
Dimensões (CxLxA)	230x90x45mm

31,50€

52454

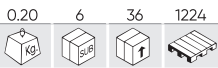

EXTRATOR DE BRAÇO DE LIMPA-PÁRA-BRISAS

Abertura	8-45mm
Peso	0,20Kg
Dimensões (CxLxA)	160x100x50mm

13,90€



53463

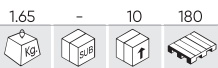

KIT DE EXTRAÇÃO DE BRAÇO DE LIMPA PRARA-BRISAS

Peças	6
Marcas	VOLKSWAGEN, OPEL, HONDA, BMW, AUDI, FORD, MERCEDES BENZ
Peso	1,65Kg
Dimensões (CxLxA)	275x230x60mm

98,00€



52852

6,80€

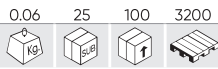

CONJUNTO DE 2 GANCHOS PARA O-RINGS



Peças	2
Peso	0,06Kg
Comprimento	210mm

53053

12,00€

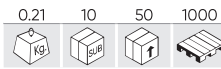

GANCHOS PARA EXTRAIR JUNTAS



Peças	3
Peso	0,20Kg
Comprimento	120, 155, 165mm

53696

23,50€

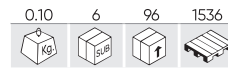

EXTRACTOR DE ABRAÇADEIRAS HENN



Peso	0,10Kg
Dimensões (CxLxA)	80x20x102mm

51496

8,00€

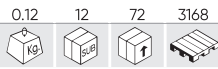

EXTRATOR DE PARAFUSOS PARTIDOS



Peças	4
Peso	0,12Kg
Dimensões (CxLxA)	170x90x20mm

53502

41,00€

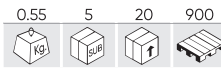

KIT EXTRATOR DE MACHOS DE ROSCAR QUEBRADOS



Peças	9
Peso	0,55Kg
Dimensões (CxLxA)	195x100x35mm

53669

45,00€

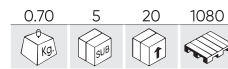

JOGO DE CHAVES DE CAIXA ESPECIAL PARA AUTOMÓVEL DE 10 PCS



Peças	10
Peso	0,70Kg
Dimensões (CxLxA)	350x80x25mm

54253

166,00€

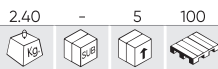

KIT DE REMOÇÃO DE PARAFUSO DE SEGURANÇA DA RODA



REPOSIÇÕES DISPONÍVEIS



VÍDEO TUTORIAL

Peças	10
Peso	2,40Kg
Dimensões (CxLxA)	300x62x225mm

53524

55,00€

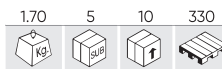

KIT DE 4 UNIDADES CORTAR PORCAS



REPOSIÇÕES DISPONÍVEIS

Peças	4
Faixa de trabalho	9-36mm
Peso	1,70Kg
Dimensões (CxLxA)	270x195x50mm

53208 126,00€

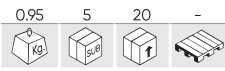

KIT DE PARAFUSO DE SEGURANÇA PARA BMW



Peças	22
Medida do quadrado	1/2"
Peso	0,95Kg
Dimensões (CxLxA)	210x55x140mm

52802 54,00€

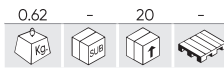

KIT DE PARAFUSO DE SEGURANÇA PARA BMW



Peças	10
Medida do quadrado	1/2"
Peso	0,62Kg
Dimensões (CxLxA)	250x120x50mm

52833 39,30€

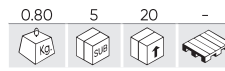

KIT DE CHAVES EXTRACTOR DE PERNOS 1/2"



REPOSIÇÕES DISPONÍVEIS

Peças	4
Medida do quadrado	1/2"
Peso	0,80Kg
Dimensões (CxLxA)	218x90x47mm

53328 76,00€

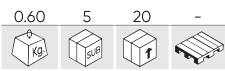

KIT DE PARAFUSO DE SEGURANÇA PARA MERCEDES



Peças	12
Medida do quadrado	1/2"
Peso	0,60Kg
Dimensões (CxLxA)	145x130x45mm

52823 124,00€

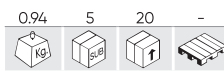

KIT DE PARAFUSO DE SEGURANÇA PARA AUDI



Peças	22
Medida do quadrado	1/2"
Peso	0,94Kg
Dimensões (CxLxA)	215x150x50mm

53207 118,00€

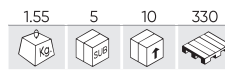

KIT DE PARAFUSO DE SEGURANÇA VW



Peças	23
Medida do quadrado	1/2"
Peso	1,55Kg
Dimensões (CxLxA)	230x16x60mm

51998 38,00€

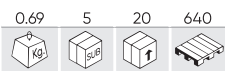

KIT DE CHAVES 3/8" PARA EXTRAÇÃO DE PORCAS



REPOSIÇÕES DISPONÍVEIS



Peças	11
Medida do quadrado	3/8"
Peso	0,68Kg
Dimensões (CxLxA)	165x115x60mm

52962 42,00€

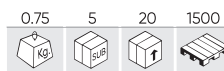

KIT DE CHAVES 3/8" PARA EXTRAÇÃO DE PORCAS



REPOSIÇÕES DISPONÍVEIS



Peças	12
Medida do quadrado	3/8"
Peso	0,75Kg
Dimensões (CxLxA)	163x110x54mm

52153 46,00€

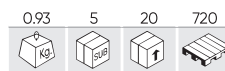

KIT DE CHAVES TWIST DE 1/2" PARA EXTRAÇÃO DE FÊMEAS



REPOSIÇÕES DISPONÍVEIS



Peças	6
Medida do quadrado	1/2"
Peso	0,93Kg
Dimensões (CxLxA)	180x135x60mm

51958

422,00€



DESMULTIPLICADOR DE ROQUETE 3/4" + REDUCTOR DE 1/2"



Peças	6
Medida do quadrado	1/2", 3/4"
Material	Cr
Medidas	13, 19mm
Torque máximo de saída	1000Nm
Relação de transmissão	1:4
Peso	4,34Kg
Dimensões (CxLxA)	375x260x85mm

52012

68,00€

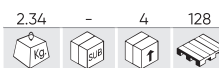

DESMULTIPLICADOR DE FORÇA



Peças	5
Medida do quadrado	1/2"
Material	CrV
Medidas	17, 19, 21mm
Torque máximo de saída	360Nm
Relação de transmissão	1:18
Peso	2,34Kg
Dimensões (CxLxA)	285x215x80mm

52056

73,00€

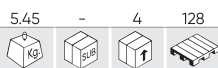

KIT DE 8 CHAVES 1" DESMULTIPLICADOR DE FORÇA



REPOSIÇÕES DISPONÍVEIS

x8 1" 22, 24, 27, 30, 32, 33, 38, 41mm

51919

89,00€



DESMULTIPLICADOR DE FORÇA COM AUMENTO



Peças	4
Medida do quadrado	1"
Material	40Cr
Medidas	32-33mm
Torque máximo de saída	5800Nm
Relação de transmissão	1:56
Peso	7,75Kg
Dimensões (CxLxA)	380x205x100mm

PARA CAMIÕES/VEÍCULOS

52796

98,00€



DESMULTIPLICADOR DE FORÇA ARTICULADO



Peças	4
Medida do quadrado	1"
Material	40Cr
Medidas	32-33mm
Torque máximo de saída	6000Nm
Relação de transmissão	1:58
Peso	8,88Kg
Dimensões (CxLxA)	395x255x120mm

PARA CAMIÕES/VEÍCULOS

FERRAMENTAS DE SINCRONISMO

FIAT/ALFA ROMEO	288	MERCEDES-BENZ	320
BMW/MINI	294	RENAULT/DACIA/NISSAN	323
PSA	304	OPEL/VAUXHALL	328
FORD	308	VAG	334
JAGUAR/LAND ROVER	315	OUTRAS	347
JEEP/CHRYSLER	319	FERRAMENTAS ADICIONAIS	349



NOVO MOTOR DE BUSCA NA WEB PARA KITS DE FERRAMENTAS DE TEMPORIZAÇÃO DE MOTORES

Descubra a nossa nova ferramenta online: um novo localizador de kits para encontrar o que precisa!

Aceda ao nosso website e localize a secção de procura de kits de regulação no menu principal.

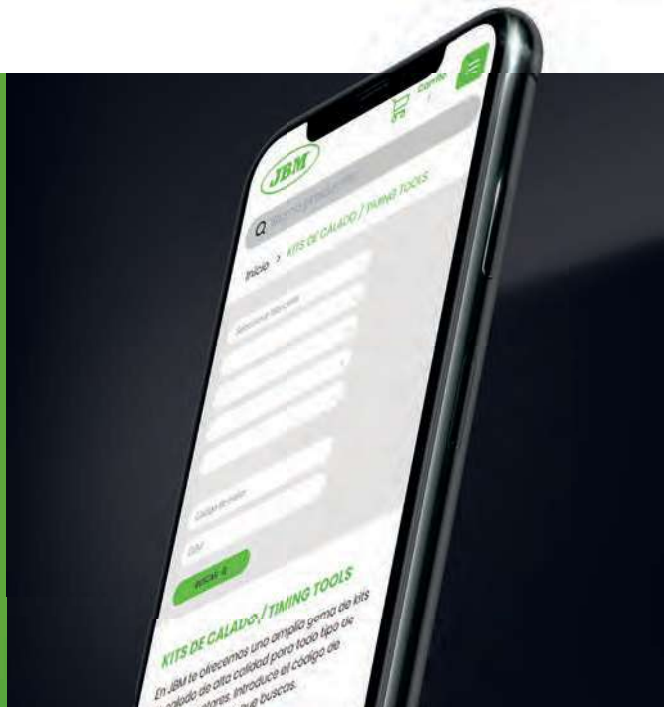

- 01 Encontre o que precisa inserindo palavras-chave no mecanismo de pesquisa.
- 02 Refine sua pesquisa com os filtros: Marca, código do motor, ferramenta OEM.
- 03 Descubra os resultados. Clique nos kits para ver mais!

54471

63,50€

2.80 - 5 112

KIT DE RETRABALHO FIAT/LANCIA-1.6

MARCAS	<p>FIAT: FIAT BRAVA (1995-2002), FIAT BRAVO (1995 - 2002), FIAT DOBLO CARGO (2002-2010), FIAT DOBLO (2002 - 2010), FIAT MAREA WEEKEND (1996-2003), FIAT MAREA (1996-2003), FIAT MULTIPLA (1999-2011), FIAT PALIO WEEKEND (1997-2006), FIAT SIENA (1997-2003), FIAT STILO (2001-2008)</p> <p>LANCIA: LANCIA DEDRA (1997-1999), LANCIA DELTA (1996-1999), LANCIA LYBRA (1999-2006)</p>
FERRAMENTAS OEM	<p>1.860.771.000 1.860.874.000 1.860.876.000</p>
CÓDIGOS DE MOTOR	<p>1.6 16v - 178.B3.000, 178B3.000, 182A4.000, 182A6.000, 182B6.000</p>



53303

89,00€

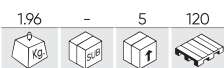

KIT DE BLOQUEIO FIAT / OPEL

MARCAS	<p>ALFA ROMEO: 145, 146, 146 JTD FIAT: 1.9D, 2.4D GM: 1.3, 1.6, 1.9, 2.0, 2.4 CDTI (2004 -)</p>
FERRAMENTAS OEM	<p>EN-46781 EN-46785 EN-46788 EN-46789 EN-46789-100</p>
CÓDIGOS DE MOTOR	<p>A20DT, A20DTLBS, A20DTLBY, A20DTLCD, Z19DT, Z19DTH, Z19DTJ, Z19DTL, 182B4.000, 182B9.000, 186A6.000, 186A8.000, 186A9.000, 188A2.000, 188A7.000, 188B2.000, 192A1.000, 192A3.000, 192A5.000, 192A8.000, 192A9.000, 192B4.000, 192B5.000, 198A2.000, 198A3.000, 198A6.000, 199A5.000, 223A7.000, 323.02, 350A2.000, 371.01, 937A2.000, 937A3.000, 939A1.000, 939A5.000, 939A7.000</p>



53304

279,00€



KIT DE BLOQUEIO FIAT

MARCAS	<p>FIAT: 1.2, 1.4, 1.6, 1.8 16V FIAT: 1.9D/TD, 1.9JTD, 2.4TD/JTD</p>
FERRAMENTAS OEM	<p>D86, FACOMD86, KMS71A, MOT.582-01, T10170A, T10170A/1, VAS6079, 0153A, 1822149000, 1822154000, 1825041000, 1825042000, 1860161000, 1860443000, 1860703000, 1860766000, 1860771000, 1860846000, 1860847000, 1860874000, 1860875000, 1860876000, 1860892000, 1860895000, 1860898000, 1860901000, 1860905000, 1860905010, 1860932000, 1860933000, 1867030000, 1895879000, 3313, 6012T, 607589014000, 6079, 976554</p>
CÓDIGOS DE MOTOR	<p>DHX, DJY, D8B, D9B, P8C, 160A7.000, 176B9.000, 178B3.000, 182A4.000, 182A6.000, 182A7.000, 182A8.000, 182B2.000, 182B6.000, 185A2.000, 188A3.000, 188A5.000, 223A6.000</p>



53306

53,00€



KIT DE BLOQUEIO FIAT 1.2 16V

MARCAS	<p>FIAT: 1.2 16V</p>
FERRAMENTAS OEM	<p>EN 46781, 0104 A, 0991768610, 104 A, 1860985000, 1871000900, 2000004500, 2000015800, 2190754500, 303 1472</p>
CÓDIGOS DE MOTOR	<p>169A3.000, 176B9.000, 182B2.000, 188A5.000, 192B2.000, 198A1.000, 198A4.000, 199A6.000, 199A8.000, 312A1.000, 312A3.000, 312A9.000, 312B3.000, 312B4.000, 312B6.000, 843A1.000, 940A6.000, 940B1.000, 940B7.000, 940B8.000, 955A1.000</p>



53308

55,00€

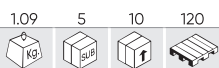

KIT DE BLOQUEIO ALFA ROMEO

MARCAS	145, 146, 147, 155, 156, 1.4 1.6 1.8 2.0 TS, 1.4/1.6 16V SPIDER/GTV (96-05): PÚRPURA / PURPLE - 1.4, 1.6 AZUL / BLUE - 1.8, 2.0 145/146 (96-01), 147 (01-10), 155/156 (95-02), 166 (98-07), 145/146, (96-01), 155/156 (96-06), SPIDER/GTV (98-05), 2.0 16V; 145/146/147/155/156 (96-10), 1.8 16V
FERRAMENTAS OEM	1822149000 1822154000 1825041000 1825042000
CÓDIGOS DE MOTOR	162.01, 322.01, 323.01, 323.10, 335.03, 671.06, 672.04, 676.01



53309

285,00€



KIT DE BLOQUEIO ALFA/FIAT/LANCIA 1.4, 1.6, 1.8, 2.0 16V, 2.0 20V

MARCAS	SPIDER/GTV (96-05): PÚRPURA / PURPLE - 1.4, 1.6 AZUL / BLUE - 1.8, 2.0
FERRAMENTAS OEM	175A3.000, 182A1.000, 182A2.000, 182B7.000, 1.822.110.000, 1.825.013.000, 1.825.041.000, 1.825.042.000, 183A1.000, 183A6.000, 185A8.000, 1.850.892.000, 1.852.161.000, 1.860.847.000, 1.860.875.000, 1.860.895.000, 1.860.899.000, 1.860.961.000, 1.870.697.000, 1.870.734.000, 1.870.797.000, 1.870.859.000, 88A6.000, 1.895.879.000, 192A4.000
CÓDIGOS DE MOTOR	162.01, 322.01, 323.01, 323.10, 335.03, 671.06, 672.04, 676.01



53310

498,00€



KIT DE BLOQUEIO FIAT/ALFA/LANCIA

MARCAS	1.2, 1.4 16V, 1.6 16V, 1.6 16V ECO, 1.8, 2.0, 2.0 16V, 2.4 20V, 3.0 20V, V6
FERRAMENTAS OEM	D86, FACOMD86, KM571A, MOT.582-01, T10170A, T10170A/1, VAS6079, 0153A, 1822149000, 1822154000, 1825041000, 1825042000, 1860161000, 1860443000, 1860703000, 1860766000, 1860771000, 1860845000, 1860846000, 1860847000, 1860874000, 1860875000, 1860876000, 1860892000, 1860895000, 1860898000, 1860899000, 1860901000, 1860905000, 1860905010, 1860932000, 1860933000, 1867030000, 1895879000, 3313, 6012T, 607589014000, 6079, 976554
CÓDIGOS DE MOTOR	DHX, DJY, DW10UTED4, D19AA, D8B, D9B, LFW, RFU, RFV, RFW, RGX, RHK, RHR, RHV, 162.01, 175 A1.000, 175 A3.000, 176 A3.000, 176 A5.000, 176 B3.000, 176B9.000, 182 A1.000, 182 A2.000, 182 A3.000, 182 A4.000, 182 A5.000, 182 A6.000, 182 A7.000 (TD 100), 182 A8.000 (TD 75), 182 B4.000, 182 B6.000, 182B2.000, 185 A6.000, 188 A3.000, 188A5.000, 192 A1.000, 192 A3.000, 323.01, 323.10, 324.01, 4HP, 4HR, 4HS, 4HT, 672.04, 673.01, 8140.43S, 836 A3.000



53312

127,00€

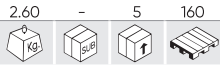

KIT DE BLOQUEIO FIAT/ALFA/FORD

MARCAS	<p>ALFA ROMEO: MITO (10-15) CHRYSLER: YPSILON FIAT: NEW 500(07-09), IDEA (04-09), LINEA (07-09), GRANDE PUNTO (07-09), DOBLO 1 CARGO (05-09), PANDA EVO2(05) FORD: KA 1.2 DURATEC (09) LANCIA: YPSILON, MUSA</p>
FERRAMENTAS OEM	<p>EN50780, EN50782, 1860987000, 1870823000, 2000004000, 2000004200, 2000004300, 2000004400, 2000004500, 2190754200, 2190754400, 2190754500, 3031477, 3031478, 3031479, 3031480, 3031560</p>
CÓDIGOS DE MOTOR	<p>169A.4000, 188A.4000, 199A.4000, 199A.7000, 350A1000</p>



53319

18,00€

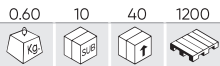

KIT DE BLOQUEIO FIAT IVECO 2.3, 3.0 JTD

MARCAS	<p>FIAT: 2.3, 3.0 JTD IVECO DAILY</p>
FERRAMENTAS OEM	<p>KM-6349, 0132AB, 0178D, 0194A, 07LAG-PT20100, 077440010400, 119790, 18G1671, 1.860.617.000, 2000018200, 21-260, 303-732, 4527TS2, 49JEO2018, 5711TD, 99360608, 99360614, 99360615, 9997169</p>
CÓDIGOS DE MOTOR	<p>F1AE0481A, F1AE0481B, F1AE0481C, F1AE0481D, F1AE0481F, F1AE0481FA, F1AE0481FB, F1AE0481G, F1AE0481GA, F1AE0481GB, F1AE0481H, F1AE0481HA, F1AE0481HB, F1AE0481N, F1AE0481R, F1AE0481RA, F1AE0481UA, F1AE0481UB, F1AE0481VA, F1AE0481VB, F1AE3481A, F1AE3481B, F1AE3481C, F1AE3481D, F1AE3481E, F1AE3481G, F1AFL411A, F1AFL411B, F1AFL411C, F1AGL411A, F1AGL411B, F1AGL411C, F1AGL411D, F1AGL411M, FICE0114A, FICE0441A, FICE0441F, FICE0481A, FICE0481B, FICE0481D, FICE0481F, FICE0481FA, FICE0481FB, FICE0481H, FICE0481HA, FICE0481HB, FICE3481C, FICE3481CC, FICE3481D, FICE3481DM, FICE3481E, FICE3481J, FICE3481K, FICE3481LC, FICE3481M, FICE3481N, FICE3481B, FICFA401A, FICFL411E, FICFL411F, FICFL411G, FICFL411H, FICFL411J, FICFL411V, FICFL411W, FICGL411A, FICGL411B, FICGL411C, F30DTE</p>



54202

68,00€

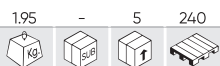

KIT DE BLOQUEIO DE DISTRIBUIÇÃO PARA FIAT/ALFA ROMEO/LANCIA

MARCAS	<p>1.2 16V, 1.4 16V, T-JET</p>
FERRAMENTAS OEM	<p>1.860.985.000 1.860.987.000 1.860.992.000 2.000.004.500 2.000.015.800</p>
CÓDIGOS DE MOTOR	<p>169A3.000, 176B9.000, 182B2.000, 188A5.000, 192B2.000, 198A1.000, 198A4.000, 198A8.000, 199A6.000, 312A1.000, 312A3.000, 843A1.000, 955A1.000</p>



54203

91,00€

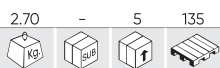

KIT DE BLOQUEIO DE DISTRIBUIÇÃO PARA ALFA ROMEO/LANCIA 1.8 TBI

MARCAS	ALFA ROMEO: 1,75 TBI LANCIA: 1,75 DI TURBO JET
FERRAMENTAS OEM	1 860 898 000 2 000 003 000 2 000 033 500
CÓDIGOS DE MOTOR	40A1.000 939B1.000 940B2.000 960A1.000



54211

74,00€

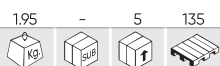

KIT DE BLOQUEIO DE DISTRIBUIÇÃO PARA FIAT/FORD/OPEL/SUZUKI 1.3L

MARCAS	FIAT: 1.3 JTD FORD: 1.3 TDCI OPEL: 1.3 CDTI SUZUKI: 1.3 CDTI
FERRAMENTAS OEM	EN 46781, EN 46785, KM 955, KM-662-C, 09912-38300, 09917-68610, 1860985000, 1870900300, 1870900400, 1871000200, 1871000900, 303-1468, 303-1469, 303-1472
CÓDIGOS DE MOTOR	Z13DT, Z13DTH, Z13DTJ, 169A.000, 188A8.000, 188A9.000, 199A3.000



54212

39,40€



KIT DE BLOQUEIO DE DISTRIBUIÇÃO PARA FIAT/LANCIA 1,4 12V

MARCAS	1.4 12V
FERRAMENTAS OEM	1 860 899 000 1 860 901 000
CÓDIGOS DE MOTOR	182A3.000 182A5.000 840A2.000 840A4.000



54215

57,00€

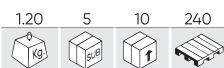

KIT DE BLOQUEIO DE DISTRIBUIÇÃO PARA ALFA ROMEO/FIAT 1.4 MULTIAIR

MARCAS	ALFA ROMEO: GIULIETTA, MITO FIAT: PUNTO, PUNTO EVO 1.4 (TURBO) MULTIAIR
FERRAMENTAS OEM	1860987000 2000004500 2000034400
CÓDIGOS DE MOTOR	940A2.000 955A2.000 955A6.000 955A7.000 955A8.000



54216

49,00€



KIT DE BLOQUEIO DE DISTRIBUIÇÃO PARA FIAT/OPEL/ALFA 1.9, 2.4L 16V

MARCAS	ALFA ROMEO: 1.9-2.4L DIESEL FIAT: 1.9-2.4L DIESEL OPEL: 1.9
FERRAMENTAS OEM	EN-46788, EN-46789, KM 6130, KM 6349, 1.860.898.000, 1.860.905.000, 1.860.905.010, 1.870.896.900
CÓDIGOS DE MOTOR	Z19DT, Z19DTH, Z19DTJ, 182B4.000, 182B9.000, 185A6.000, 186A6.000, 186A8.000, 186A9.000, 188A2.000, 188A7.000, 188B2.000, 192A1.000, 192A3.000, 192A5.000, 192A8.000, 192A9.000, 192B1.000, 192B4.000, 192B5.000, 198A2.000, 198A3.000, 198A6.000, 199A5.000, 223A7.000, 323.02, 325.01, 342.02, 362.02, 371.01, 839A6.000, 841C.000, 937A2.000, 937A3.000, 937A4.000, 937A5.000, 939A1.000, 939A2.000, 939A3.000, 939A7.000, 939A8.000



54430

34,00€



KIT DE BLOQUEIO ALFA ROMEO/FIAT/LANCIA 0.9 TWIN AIR

MARCAS	ALFA ROMEO: MITO (2001-2018) CHRYSLER: YPSILON (2011-2015) FIAT: 500/500C (2010-2020), 500L/500L LIVING/500L MPW (2012-2018), PUNTO (2012-2018), PANDA (2012-) LANCIA: YPSILON (2011-2018)
FERRAMENTAS OEM	2 000 035 100 2 000 035 200 2 000 035 300
CÓDIGOS DE MOTOR	199B6.000 199B7.000 312A2.000 312A4.000 312A5.000 312A6.000



54444

134,00€

2.20 - 2 48



KIT DE BLOCO DE MOTOR A GASOLINA BMW M3 -S54

MARCAS	BMW: M3 CABRIOLET 2000-2006, M3 SPORTS COUPE 1999-2006, M3 CSL SPORTS COUPE 2003-2004 BMW M3 CABRIOLET 2000-2006, M3 SPORTS COUPE 1999-2006, M3 CSL SPORTS COUPE 2003-2004 FOR PLUS: Z3 (M) E36 2000 ONWARDS, Z4 (M) E85/E86 2006 ONWARDS
FERRAMENTAS OEM	112300 117160 117342 119130 119140 119170
CÓDIGOS DE MOTOR	S50B30 S50B32 S54B32

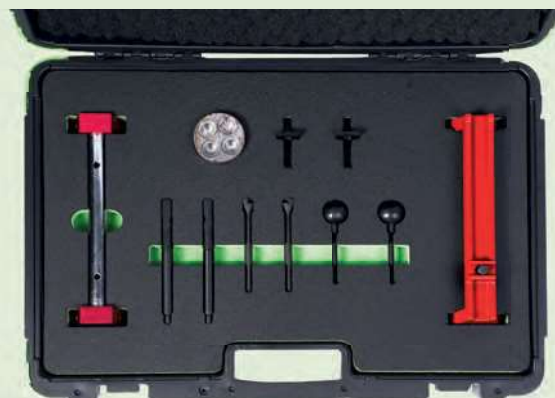

54445

105,00€

3.60 - 5 -



KIT DE BLOQUEIO DE MOTOR A GASOLINA BMW M3 S65

MARCAS	BMW: E90 M3 & E92 M3 S65 ENGINE (2007-2013)
FERRAMENTAS OEM	115 290 115 320 115 370 119 970
CÓDIGOS DE MOTOR	S65 B40A / 4.0L



54441

172,50€

3.00 - 2 48



CONJUNTO DE AFINAÇÃO DO MOTOR BMW N47/N57

MARCAS	BMW: SERIE 1, 2, 3, 4, 5, 6, 7, X1, X3, X4, X5, X6 MINI: CLUBMAN, MINI, COUPE, ROADSTER, COUNTRYMAN, PACEMAN
FERRAMENTAS OEM	113340 114320 115320 116480 118740 118741 118750 118760 118790
CÓDIGOS DE MOTOR	N47 C16A, N47 C20A, N47 D16A, N47 D16C, N47 D20A, N47 D20B, N47 D20C, N47 D20D, N57 D30A, N57 D30B, N57 D30C, N57 D30D, N57 D30TO, N57 D30UO



53259

97,00€

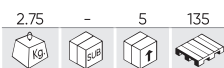

KIT DE BLOQUEIO BMW N42, N46 1.8, 2.0 CADEIA

MARCAS	X1 XDRIVE18I (E84) 2010-2012 X3 XDRIVE 20I (E83) 2005-2010 Z4 2.0 (E85/E86) 2004-2009 1 SERIES 118I, 120I (E81/82/87/88) 2004-2014 3 SERIES 318I/ 318TI COMPACT (E46) 2001-2007 3 SERIES 318I, 320I (E90/91/92/93) 2005-2014 5 SERIES 520I (E60/E61) 2007-2010
FERRAMENTAS OEM	KM813, LRT12108, LRT12171, 112300, 115120, 119190, 119291/3, 119292, 119293, 119340, 119340A, 119340/341, 119341, 119350, 119350/351, 119351, 12108, 12171
CÓDIGOS DE MOTOR	N42B18A, N42B20, N42B20A, N46B18, N46B18A, N46B20, N46B20B, N46TB20, N46TB20B, N46TB20BD, N46TB20BZ, N46TB20O2



53260

168,00€

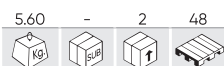

KIT DE BLOQUEIO BMW N43 1,6/2,0 CADEIA

MARCAS	1 SERIES 116I, 118I, 120I (E81/82/87/88) 2007-2014 3 SERIES 318I, 320I (E90/91/92/93) 2007-2014 5 SERIES 520I (E60/61) 2007-2014
FERRAMENTAS OEM	113340, 115120, 118690, 118691/11, 118700, 118710, 118711/11, 119340, 119341, 119342, 8692/11, 8693, 8712
CÓDIGOS DE MOTOR	N43B16A, N43B16AA, N43B16OO, N43B20A, N43B20AA, N43B20AY, N43B20KO, N43B20UO



53261

214,00€



KIT DE BLOQUEIO BMW N42, N46 1.8, 2.0

MARCAS	X1 XDRIVE18I (E84) 2010-2012 X3 XDRIVE 20I (E83) 2005-2010 Z4 2.0 (E85/E86) 2004-2009 1 SERIES 118I/120I (E81/82/87/88) 2004-2014 3 SERIES 318I/318TI COMPACT (E46) 001-2007 3 SERIES 318I/320I (E90/91/92/93) 2005-2014 5 SERIES 520I (E60/E61) 2007-2010
FERRAMENTAS OEM	119302 119303 119310 119320 119390
CÓDIGOS DE MOTOR	N42B18A, N42B20A, N46B18, N46B20, N46B20B, N46TB20O2, N46TB20, N46TB20B, N46TB20BD, N46TB20BZ, N46TB20O2

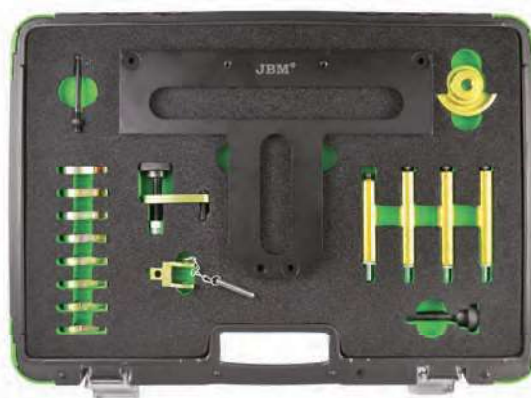

53262

251,00€



KIT DE BLOQUEIO EIXO DE COMANDO BMW M52TU, M54, M56 DUPLO VÃOS

MARCAS	BMW: X3 2.5, 3.0 (E83) 2003-2007, X5 3.0 (E53) 1999-2007, Z3 2.0, 2.2, 2.8, 3.0 (E36) 1999-2003, Z4 2.2, 2.5, 3.0 (E85/86) 2003-2006, 3 SERIES 320I, 323I, 325I, 325TI, 328I, 330I (E46) 1998-2007, 5 SERIES 520I, 523I, 525I, 528I, 530I (E39) 1998-2003, 5 SERIES 520I, 525I, 530I (E60/61) 2003-2005, 7 SERIES 728I (E38) 1998-2002, 7 SERIES 730I (E65/66) 2002-2005
FERRAMENTAS OEM	KM823, LRT12114, LRT12222, 113292, 113390, 113390/11, 113450, 116150, 116180, 12114, 12222
CÓDIGOS DE MOTOR	M52B20, M52B25, M52B28, M54, M54B25, M54B30, M56, 206S4, 226S1, 256S4, 256S5, 286S2, 306S3



53263

57,00€

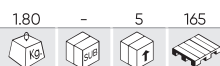

KIT BLOQUEIO EIXO DE COMANDO BMW M47 LAND ROVER TD4,TD6

MARCAS	BMW: X3 2.0D, 3.0D/SD, XDRIVE 30D, XDRIVE 35D (E83) 2003-2010, X5 3.0 D TURBO (E53) 2003 - 2007, X5 3.0 SD, XDRIVE 30D, XDRIVE 35D (E70) 2006-2010, X6 XDRIVE 30D, XDRIVE 35D (E71) 2008-2010, 1 SERIES 118D, 120D (E81/82/87/88) 2004-2007, 3 SERIES 318D, 318TD, 320D, 320TD, 330D (E46) 1998-2007, 3 SERIES 318D, 320D, 325D, 330D, 335D (E90/91/92/93) 2005-2013, 5 SERIES 520D, 525D, 530D (E39) 1998-2003, 5 SERIES 520D, 525D/XD/XDRIVE, 530D, 535D (E60/61) 2003-2010, 6 SERIES 635D (E63/64) 2007-2011, 7 SERIES 730D (E38) 1998-2002, 7 SERIES 730D (E65/66) 2002-2008 LAND ROVER: FREELANDER (L314) 2000-2006, RANGE ROVER (L322) 2002-2006, MG ZT/ZT-T 2001-2005, ROVER 75 1999-2005
FERRAMENTAS OEM	KM813, LRT12108, LRT12171, LRT12173, 112300, 115120, 116320, 116321, 116322, 12108, 12171, 12173,
CÓDIGOS DE MOTOR	M47, M47R, M47TU, M47T2, M57, M57TU, 204D1, 204D3/TD4, 256D1, 306D1, 306D1/TD6, 306D2



53264

143,00€



KIT DE BLOQUEIO BMW N62, N73

MARCAS	BMW: X5 X5 4,4 (E53) 1999-2007, X5 X5 4,4, XDRIVE 48I (E70) 2006-2013, 5 SERIES 540I, 545I, 550I (E60/61) 2003-2010, 6 SERIES 645I, 650I (E63/64) 2003-2011, 7 SERIES 735I, 740I, 745I, 750I, 760I (E65/66) 2002-2008
FERRAMENTAS OEM	119190 119340 119461 119462 119463
CÓDIGOS DE MOTOR	N62, N62B36A, N62B40A, N62B44A, N62B48A, N62B48B, N62TU, N73, N73B60A



53265

195,00€

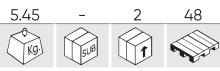

KIT DE BLOQUEIO BMW DIESEL M47, M57, M41, M51

MARCAS	BMW: X3 E83 2004-UP, X5 E53 2000-UP, X5 E70 2007-UP, X6 E71,E72 2008-UP, 1 SERIES 118D, 120D, E87 2003-UP, 3 SERIES 318/320/330 E46 1998-U, 318/320/325/330/335 E90, E91 2005-UP, 5 SERIES 520/525/530 E39 1998, 520, 525, 530, 535 E60, E61 2004-UP, 6 SERIES 635 E63, E64 2007-UP, 7 SERIES 730 E38 1998-UP, SERIES 730 E65, E66 2004-2008
FERRAMENTAS OEM	112300, 13340, 116320, 116321, 116322, 135190, 135191, 135192
CÓDIGOS DE MOTOR	M41, M47, M47R, M47TU, M47T2, M51, M57, M57TU, M57T2, X25DT, 204D3, 256T, 306D1



53266

224,00€

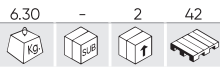

KIT DE BLOQUEIO BMW M42, M43, M50, M51, M52

MARCAS	BMW: Z3 1.9 1996-1999, Z3 1.9 1999-2003, 316 1.6 E36 COMPACT 1994-2001, 316 1.6 E36 1993-1999, 316 1.6 E46 1998-2004, 316 1.6 E46 1999-2001, 318 1.8 E30 16V 1989-1991, 318 1.8 E36 S/COUPE 1992-1998, 318 1.8 E36 S/COUPE 1996-1999, 318 1.8 E36 TI COMPACT 1996-2001, 318 1.8 E36 TI 1994-1998, 318 1.8 E36 1993-1999, 318 1.8 E46 1998-2004, 320 2.0 E36 24V 1991-1997, 325 2.5 E36 24V 1991-1997, 518 1.8 E34 1994-1996, 520 2.0 E34 24V 1989-1996, 525 2.5 E34 24V 1989-1996, 535 3.5 E39 1996-2000, 540 4.0 E39 1996-2000, 735 3.5 E38 1996-2002, 740 4.0 E38 1996-2002, 750 5.0 E32/38 1987-2002, 840 4.0 E31 1993-1999, 850 5.0 E31 1990-1999
FERRAMENTAS OEM	KM 813, KM811, KM823, LRT12108, LRT12112, LRT12114, LRT12171, 10171, 112300, 113190, 113240, 113292, 113320, 113390, 114220, 115120, 115490, 12108, 12112, 12114, 12171 KM 813, KM811, KM823, LRT12108, LRT12112, LRT12114, LRT12171, 10171, 112300, 113190, 113240, 113292, 113320, 113390, 114220, 115120, 115490, 12108, 12112, 12114, 12171
CÓDIGOS DE MOTOR	M42, M43, M50, M50B20, M50B25, M51, M52, M52B20, M52B25, M52B28, 206S1, 206S2, 206S3, 256S1, 256S2, 256S3, 286S1



53267

277,00€

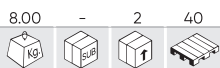

KIT DE BLOQUEIO BMW BMW M40, M43, M42, M44, M52, M54, M56

MARCAS	BMW: Z3 1.9 1996-1999, Z3 1.9 1999-2003, 316 1.6 E36 COMPACT 1994-2001, 316 1.6 E36 1993-1999, 316 1.6 E46 1998-2004, 316 1.6 E46 1999-2001, 318 1.8 E30 16V 1989-1991, 318 1.8 E36 S/COUPE 1992-1998, 318 1.8 E36 S/COUPE 1996-1999, 318 1.8 E36 TI COMPACT 1996-2001, 318 1.8 E36 TI 1994-1998, 318 1.8 E36 1993-1999, 318 1.8 E46 1998-2004, 320 2.0 E36 24V 1991-1997, 325 2.5 E36 24V 1991-1997, 518 1.8 E34 1994-1996, 520 2.0 E34 24V 1989-1996, 525 2.5 E34 24V 1989-1996, 535 3.5 E39 1996-2000, 540 4.0 E39 1996-2000, 735 3.5 E38 1996-2002, 740 4.0 E38 1996-2002, 750 5.0 E32/38 1987-2002, 840 4.0 E31 1993-1999, 850 5.0 E31 1990-1999
FERRAMENTAS OEM	112300, 113190, 113240, 113290, 113291, 113292, 113450, 114220, 115490, 116180
CÓDIGOS DE MOTOR	M40B16, M42B18, M43, M43B16, M43B18, M43TUB19UL, M44B19, M50B20, M50B20TU, M50B25, M50B25TU, M52B20, M52B20TU, M52B25, M52B25TU, M52B28, M52B28TU, M54B22, M54B25, M54B30, M56



54293

17,50€

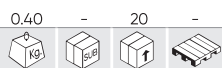

CONTRA-MANCAL DA CAMBOTA PARA BMW

MARCAS	BMW: 20D XDRIVE (2009-2015), 23D XDRIVE (2009-2012), X3 E83: 2.0D (2007-2008), 18D XDRIVE (2008-2010), X5 E70: 3.0D XDRIVE (2010-2013), 40D (2010-2013), X6 E71/71: 30D XDRIVE (2010-2014), 40D XDRIVE (2010-2014), 1 SERIES E81/82/87/88: 116D (2008-2012), 118D (2007-2012), 120D (2007-2014), 123D (2007-2014), 1 SERIES F22: 218D (2011-2014), 220D (2011-2014), 225D (2011-2014), 3 SERIES E90/91/92/93: 316D (2007-2012), 318D (2007-2014), 320D (2007-2012), M550D XDRIVE (2012-2015), 5 SERIES F07: 535D GT (2009-2015), 7 SERIES F01/02/04: 730D (2008-2012), 740D (2009-2012), 750D XDRIVE (2012-2015), X1 E84: 18D SDRIVE (2009-2015), 20D SDRIVE (2009-2015), 18D XDRIVE (2009-2015), 325D (2010-2012), 330D (2008-2014), 5 SERIES E60/61: 520D (2007-2010), 5 SERIES F10/11: 525D (2010-2013), 530D (2010-2013), 530D XDRIVE (2011-2015), 535D (2010-2013), 535D XDRIVE (2011-2015)
FERRAMENTAS OEM	114320
CÓDIGOS DE MOTOR	D20A, D20A/KO, D20B, D20B/TO, D20C, D20K1, D20O0, D20O1, D20TO, D20U0, D20U1, D30A, D30A/O0, D30A0/O0, D30A0/O1, D30B, D30B/T1, D30C, D30C/S1, D30O0, D30O1, D30TO, D30U0, N47, N47D20C, N47D20D, N57



53269

50,00€

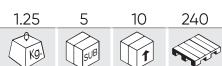

KIT DE BLOQUEIO BMW N47, N47S, N57 (PARA UTILIZAÇÃO COM 54293)

MARCAS	BMW: SERIES 1, 2, 3, 5, 7, X, MINI
FERRAMENTAS OEM	115320 116480 118740 118760
CÓDIGOS DE MOTOR	N47C16AU1, N47C16K1, N47C16U1, N47C20A/K1, N47C20K1, N47C20U1, N47D16, N47D16C, N47D20A, N47D20AK0, N47D20A/O0, N47D20C, N47D20C/O, N47D20C/O1, N47D20D, N47D20O0, N47D20O1, N47D20U0, N47SD20BD, N47SD20D/TO, N47TD20K1, N47TD20O1, N47TD20U1, N57D30, N57D30A, N57D30A/O0, N57D30A/O1, N57D30A0/O0, N57D30B, N57D30B/TO, N57D30B/T1, N57D30C, N57D30O0, N57D30O1, N57D30TO, N57D30TO, N57D30U0, N57D30U0



54219

60,00€

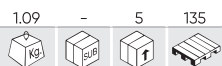

KIT DE BLOQUEIO DE DISTRIBUIÇÃO PARA BMW/MINI/CITROËN/PEUGEOT

MARCAS	BMW: 1.6, 1.8, 2.0, 3.0 MINI: 1.4, 1.6 PSA: 1.4, 1.6 16V
FERRAMENTAS OEM	113340 114360 115140 119280 119330
CÓDIGOS DE MOTOR	B16, B16A, B16AC, EP3, EP6, EP6DT, EP6DTS, N12, N14, N40, N42, N45, N45T, N46, N46T, N51, N52, N53, N54



54222

59,00€

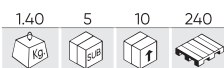

KIT DE DISTRIBUIÇÃO PARA MINI 1.6

MARCAS	CITROËN: DS3 2006-2010, C4 2006-2010, GRAND PICASSO 2006-2010 MINI: COOPER S 2007-2010 PEUGEOT: 207 2006-2010, 307 2006-2010, GT 2006-2010, THP 2006-2010, GTI 2006-2010
FERRAMENTAS OEM	119550 119551 119552 119590
CÓDIGOS DE MOTOR	N14 B16A N14 B16CD N14 B16TO



54227

122,00€

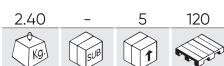

KIT DE DISTRIBUIÇÃO PARA BMW/MINI N13, N18

MARCAS	BMW MINI PSA
FERRAMENTAS OEM	0 496 709, 0109 2B, 0197 A11, 0197 A3, 0197 A31, 0197-A1, 0197-A1Z, 0197-A11, 0197A2, 0197-A31, 0197-A32, 0197-A33, 0197-BZ, 0197-M, 0197-N, 11 7 440, 11 9 340, 11 9 540, 11 9 551, 11 9 590, 1376-A, 2 299 362
CÓDIGOS DE MOTOR	EP3, EP3C, EP6, EP6C, EP6CDT, EP6CDTM, EP6CDTR, EP6CD-TX, EP6DT, EP6DTE, EP6DTS, EP6FADTX, EP6FADTXD, EP6FDT, EP6FDTM, EP6FDTX, N12 B14A, N13 B16A, N14 B16A, N14 B16C, N16 B16A, N18 B16A, N18 B16C, 5FA, 5FD, 5FE, 5FF, 5FG, 5FH, 5FK, 5FL, 5FM, 5FN, 5FP, 5FR, 5FS, 5FT, 5FU, 5FV, 5FW, 5FX, 5FY, 5GF, 5GG, 5GM, 5GN, 5GP, 5GR, 5GT, 5GW, 5GY, 5GZ, 8FN, 8FP, 8FR, 8FS



54228

187,00€



KIT DE BLOQUEIO DE DISTRIBUIÇÃO PARA BMW/MINI 1.2, 1.5, 2.0, 3.0

MARCAS	BMW: 1.5, 1.6, 2.0, 3.0 MINI: 1.2, 1.5, 2.0
FERRAMENTAS OEM	11 4 120 2 288 380 2 357 904 2 358 122 2 365 488 2 456 372
CÓDIGOS DE MOTOR	B36 A15A, B38 A12A, B38 A15A, B38 A15A, B38 B15A, B38 K15A, B46 B20A, B48 A20A, B48 A20B, B48 A20E, B48 B16A, B48 B20A, B48 B20B, B58 B30A, B58 B30B, B58 B30C



54206

113,00€

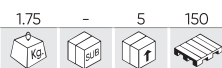

KIT DE BLOQUEIO DE DISTRIBUIÇÃO PARA BMW/MINI 1.5, 2.0L

MARCAS	BMW: SERIES 1, 2, 3, 4, 5, X1, X3, X4, X5, MINI: CLUBMAN, ONE D, COOPER D/SD MINI HATCH
FERRAMENTAS OEM	11 4 120 11 8 030 11 8 740 11 8 76 2 288 380 2 347 904 2 365 488
CÓDIGOS DE MOTOR	B37 C15A B37 D15A B47 C20A B47 C20B B47 D20A B47 D20B



54398

41,00€

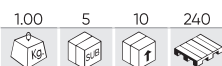

JOGO DE BLOQUEIO DE VOLANTE / POLIA DA CAMBOTA PARA BMW/MINI

MARCAS	MINI: HATCH (14-21), CABRIOLET (16-19), CLUBMAN (15-19), COUNTRYMAN (17-19)
FERRAMENTAS OEM	11 4 180 11 6 480 11 9 265 11 9 810 11 9 811
CÓDIGOS DE MOTOR	B37, B38, B47, B48, i8, M140i, M240i, X1, X2, X3, X4, X5, 116d, 116i, 118d, 120d, 125d, 214d, 216d, 216i, 218d, 218i, 220d, 225d, 316d, 318i, 320d, 325d, 330i, 340i, 418i, 420d, 425d, 430i, 440i, 518d, 525d, 530i, 540i, 620d, 630i, 640i, 725d, 730i, 740i



54399

56,50€

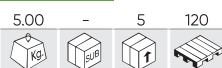

KIT DE BLOQUEIO BMW/RANGE ROVER/OPEL 2.5D

MARCAS	BMW: 318TDS (94-00) , 325TD (91-99) , 325TDS (91-99) , 525TD (90-03) , 525TDS (90-03) , 725TDS (95-02) RANGE ROVER: P38 (94-02) VAUXHALL/OPEL: OMEGA-B (94-01)
FERRAMENTAS OEM	KM811, KM813, KM822, KM823, 112300, 113320, 113340, 113360, 115120, 12108, 12112, 12115, 12-172
CÓDIGOS DE MOTOR	M41/174T1, M51/256T1, X25DT, 25DT, 256T



54400

141,00€

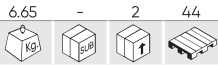

KIT DE BLOQUEIO BMW N20, N26

MARCAS	BMW: 1 SERIES 125I - F20/21 (2012-2016) 2 SERIES COUPE 220I, 228I - F22 (2014-2016), 2 SERIES CABRIOLET 220I 228I - F23 (2015-2016), 3 SERIES 320I 328I XDRIVE - F30/31 (2012-2015), 3 SERIES GRAN TURISMO 320I, 328I/XDRIVE - F34 (2013-2016), X4 XDRIVE20I, 28I (F26) 2014 - 2018, X5 XDRIVE40E (F15) 2015 - 2018, Z4 SDRIVE18I, 20I, 28I (E89) 2011 - 2017, 4 SERIES COUPE 420I, 428I/XDRIVE - F32(2013-2016), 4 SERIES CABRIOLET 420I, 428I/XDRIVE-F33 (2014-2016) 4 SERIES GRAN COUPE 420I, 428I/XDRIVE F36 (2014-2016), SERIES 520I, 528I/XDRIVE(F10/11) 2010 - 2017, 5 SERIES GRAN TURISMO 528I-(F07) 2013 - 2016, X1 SDRIVE16I, 18I, 20I, XDRIVE20I, 28I-(E84) 2011 - 2015, X3 SDRIVE18I, 20I, XDRIVE20I, 28I (F25) 2011 - 2017
FERRAMENTAS OEM	11 9 340A, 11 9 341, 11 9 340/341, 119340, 2 212 830, 2 212 831, 2 219 548
CÓDIGOS DE MOTOR	B16A, B20, B20A, B20B, B2000, B26, N20, N20B/UO, N26



54401

57,00€

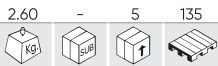

KIT DE BLOQUEIO BMW/MINI N13, N18

MARCAS	BMW: 114I (2012-2015), 116I (2012-2015), 118I (2011-2015), 316I (2012-2015) MINI: CLUBMAN (R55) (2011-2014), COOPER S (R56/57) (2010-2015), COUNTRYMAN (R60) (2012-2016), COUPE COOPER S (R58) (2012-2015), PACEMAN (R61) (2013-2017), ROADSTER (R59) (2012-2015)
FERRAMENTAS OEM	11-7-440 11-9-340 119-590 496-709
CÓDIGOS DE MOTOR	N13 B16A, N18 B16A, N18 B16/MO, N18B16A/MO, N18B16C, 18B16C/TO, N18B16MO



54402

201,00€

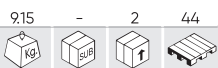

KIT DE BLOQUEIO BMW N51, N52, N53, N54, N55

MARCAS	BMW: X1 XDRIVE25I, XDRIVE28I (E84) 2009-2011, X3 SI, XDRIVE25I, XDRIVE30I (E83) 2006-2010, X3 XDRIVE28I (F25) 2011-2017, X4 XDRIVE35I, M40IX (F26) 2014-2018, X5 SI, XDRIVE30I (E70) 2006-2013, X5 XDRIVE35I (F15) 2013-2018, X6 XDRIVE35I (E71) 2008-2014, 6 XDRIVE35I (F16) 2015-2019, Z4 SDRIVE23I, SDRIVE30I, SDRIVE35I (E89) 2009-2017, Z4 SI (E85/86) 2006-2009, 1 SERIES M135I/XDRIVE (F20) 2012-2016, 1 SERIES 125I, 130I, 135I, M COUPE (E81/82/87/88) 2005-2014, 2 SERIES M235I/XDRIVE, M2 (F22/23) (F87) 2014-ON, 3 SERIES 323I, 325I, 330I, 335I (E90/91/92/93) 2005-2014, 3 SERIES 335I/XDRIVE, M3 (F30/31/34)(F80) 2012-2019, 4 SERIES 435I/XDRIVE, M4 (F32/33/36)(F82/83) 2013-2020, 5 SERIES 523I, 525I, 530I, XI/XDRIVE (E60/61) 2005-2010, 5 SERIES 523I, 528I, 530I (F10/11) 2010-2017, 6 SERIES 630I (E63/64) 2004-2011, 6 SERIES 640I/XDRIVE (F12/13/06) 2011-2018, 7 SERIES 730I (E65/66) 2005-2008, 7 SERIES 730I, 740I (F01/02/04) 2008-2015
FERRAMENTAS OEM	110300, 114280, 114281, 114282, 114283, 114285, 114290, 118520, 119340, 119340A, 119341
CÓDIGOS DE MOTOR	N51 B30A, N52 B25A, N52 B25AE, N52 B25AF, N52 B30A, N52 B30AF, N53 B25A, N53 B30A, N54 B30A, N55 B30A, S55 B30A



54403

225,00€

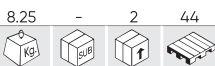

KIT DE BLOQUEIO BMW / LAND ROVER

MARCAS	BMW: 5 SERIES: 530I, 540I (E34) (1992 – 1996), 535I, 540I (E39) (1996 – 2003), 7 SERIES: 730I, 735I, 740I (E38) (1994 – 2002), 730I, 740I (E32) (1992 – 1994), 8 SERIES: 840I (E31) (1993 – 1999) LAND ROVER/RANGE ROVER: (L322) (2002 – 2005) X5: 4.4, 4.6 (E53) (1999 – 2004)
FERRAMENTAS OEM	KM 813, LRT 12 108, LRT 12 171, LRT 12 220, LRT 12 221, LRT 12 222, LRT -12 223/2, LRT 12 223/3, LRT 12 223/4, LRT 12 224, LRT 12 226, LRT 12 227, LRT 12 228/1, LRT 12 228/2, LRT 12-223/1, 11 2 300, 11 2 441, 11 2 441/445, 11 2 442, 11 2 442/446, 11 2 445, 11 2 446, 11 3 310, 11 3 390, 11 5 120, 11 5 180, 11 6 420, 11 6 440, 11 6 452, 11 7 380, 113390/117380, 116451, 12 108, 12 171, 12 220, 12 221, 12 222, 12 223/1, 12 223/3, 12 223/4, 12 224, 12 226, 12 227, 12 228/1, 12 228/2
CÓDIGOS DE MOTOR	M60 B30, M60 B40, M62 B35, M62 B44, M62 B46, M62 TUB35, M62 TUB44, V8/44 8S 2, 30 8S 1, 35 8S 1, 35 8S 2, 40 8S 1, 44 8S 1, 44 8S 2, 46 8S 1



54404

131,00€

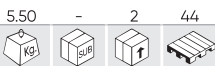

KIT DE BLOQUEIO BMW N62, N73

MARCAS	BMW: X5 X5 4,4 (E53) 1999-2007, X5 X5 4,4, XDRIVE 48I (E70) 2006-2013, 5 SERIES 540I, 545I, 550I (E60/61) 2003-2010, 6 SERIES 645I, 650I (E63/64) 2003-2011, 7 SERIES 735I, 740I, 745I, 750I, 760I (E65/66) 2002-2008
FERRAMENTAS OEM	B117270, 13460, 119190, 119340, 119451, 119452, 119453, 119454, 119461, 119462, 119463
CÓDIGOS DE MOTOR	N62 B36A, N62 B40A, N62 B44A, N62 B48A, N62 B48B, N73 B60A



54405

111,00€

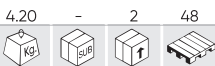

KIT DE BLOQUEIO BMW N63, N74

MARCAS	BMW: SERIES 5, SERIES 6, SERIES 7, X5, X6
FERRAMENTAS OEM	11 8 090, 11 9 190, 11 9 891, 11 9 892, 11 9 893
CÓDIGOS DE MOTOR	N63, N74, S63



54406

73,00€

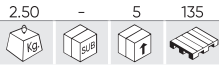

BLOQUEADOR DO VOLANTE DO MOTOR BMW/MINI

MARCAS	BMW: Z SERIES: Z4 E85/86 (04-09), Z4 (E89) (11-15), 1 SERIES: F20/21 (12-15), 116i (04-12), 118i (04-14), 120i (04-14), 130i (05-07), 135i (07-11), 116D (08-12), 118D (04-14), 120D (04-14), 123D (07-14), M COUPE (11-12), 3 SERIES: F30/31 (12-15), 316TI (04-14), 316i (04-11), 316D (09-12), 318i (04-07), 318TI/COMPACT (04-04), 3 SERIES: 318D (03-12), 318TD (03-07), 320D (01-07), 320D COMPACT (01-05), 318i (05-13), 320D (07-14), 320i (05-14), (05-14), 320Si(05-06), 3 SERIES: 323i (05-11), 325i (05-14), 325D (06-10), 330D (05-08), 330i (06-13), 335D (05-13), 335i (05-11), 4 SERIES: 420i F32 (13-15), 428i F32 (13-15), 420i F33 CABRIOLET (14-15), 428i F33 CABRIOLET (14-15), 420i F36 (14-15), 428i F36 GRAN COUPE (14-15), 5 SERIES: F10/11 (10-15), 520D (05-10), 520i (07-10) 523i (03-10), 525D (05-10), 525i (05-10), 525i (07-10), 530D (03-10), 530i (05-10), 535D (04-10), 6 SERIES: 630i (04-11), 635D (07-11), 7 SERIES: 730D (05-08), 730i (02-08) BMW X SERIES: X1 E84 (09-15), X3 E83 (03-14), X5 E53 (03-14), X3 F25 (11-15), X6 E71/72 (08-10) MINI: MINI (03-06)
FERRAMENTAS OEM	11 8 180, 11 8 181, 11 8 182, 11 8 183, 11 8 184, 11 8 185
CÓDIGOS DE MOTOR	M47T2, 57T2, 67, N43, N45, N45T, N46, N46T, N47, N51, N52, N53, N54, W17



54324

11,00€

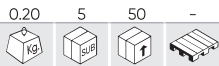

INDICADOR DE DESGASTE DA CORRENTE DE DISTRIBUIÇÃO MINI

MARCAS	BMW: SERIES 1, 2, 3, 4, 5, 6, 7, X1, X2, X3, X4, X5, X6 MINI: CLUBMAN (2007-2014), CLUBVAN (2012-2014), COUNTRYMAN (2010-2017), COUPÉ (2011-2015), MINI (2006-2015), PACEMAN (2013-2017), ROADSTER (2012-2015)
FERRAMENTAS OEM	2353281
CÓDIGOS DE MOTOR	N12 B14, N13, N16 B16A, N16 B16A/M0, N16 B16K0, N16 B16M0, N16 B16U0, N18, N18 B16A, N18 B16A/M0, N18 B16C, N18 B16C/T0, N18 B16M0, N47, N57, 1.4 N12 B14AB, 1.6 N12 B16A



54442

32,50€

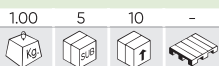

ALINHADOR DA BOMBA DE ÓLEO E EIXO DE EQUILÍBRIO BMW

MARCAS	BMW: X1 (E84), X3 (F25), X5 (F15), Z4 (E89), 1 SERIES (F20/F21), 2 SERIES (F22/F23), 3 SERIES (F30/F31/F34), 4 SERIES (F32/F33/F36), 5 SERIES (F10/F11)
FERRAMENTAS OEM	114120, 2212825, 2318117
CÓDIGOS DE MOTOR	N20B16A, N20B20, N20B20A, N20B20B, N26B20, N26B20A



53268

92,00€



KIT DE BLOQUEIO BMW/MINI/PSA 1.4, 1.6

MARCAS	BMW MINI PSA: 1.4, 1.6 16V
FERRAMENTAS OEM	0197-A1, 197-A3, 0197-B, 0197-BZ, 115540, 115590, 119340, 119550
CÓDIGOS DE MOTOR	EP3, EP3C, EP6, EP6C, EP6CDT, EP6DT, EP6DTS, N12B14, N12B14AB, N14B16A, N14B16CD, N14B16CD/TO, N14B16TO, N16B16A, N16B16A/MO, N16B16A/MO, N16B16KO, N16B16MO, N16B16UO, 5FS, 5FT, 5FV, 5FW, 5FX, 5FY, 8FR, 8FS



54722

34,50€

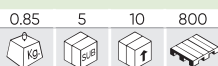

SINCRONIZAÇÃO DO MOTOR E KIT TENSOR - PARA FORD E PSA DIESEL

MARCAS	VAUXHALL / OPEL: COMBO-E (2018 - ON), CROSSLAND X (2017-2021), GRANDLAND X (2017-2021), VIVARO - C (2019 - ON)
FERRAMENTAS OEM	01099-B1, 01099-B2, 0188-Q1, 0194-A, 0194-B, 0194-C, 0194-D, 0194-J
CÓDIGOS DE MOTOR	DV5RC/YHZ (LQP/D15DTH), DV5RD/YHY (LQJ/D15DT), DV5RE/YHW (LQJ/D15DTL), DV5RUCD/YHR, DV5RUC/YHV, DV6FC (LDI/B16DTH), DV6FC/BHX (LEK/B16DT), DV6FE/BHW (LEK/B16DTL)

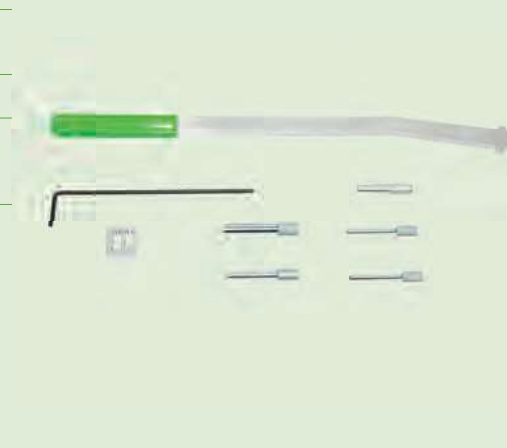

54739

62,00€



FERRAMENTA DE BLOQUEIO DA TEMPORIZAÇÃO DA ÁRVORE DE CAMES DO MOTOR PSA PEUGEOT CITROËN

MARCAS	CITROËN: C-ELYSEE (12-15), C3 II (12-15), C4 CACTUS (14-15), DS3 (12-15) PEUGEOT: 108 (14-15), 2008 (13-15), 208 (12-15), 308 (13-15) PSA: 1.0, 1.2 CTI VAUXHALL/OPEL: 1.0L, 1.2L 3-CYLINDER
FERRAMENTAS OEM	J-0109-2C, J-0109-2D, 0109 2A, 0197-N, 52127101092B, 52127-2
CÓDIGOS DE MOTOR	EBO(ZMZ), EB2D(HMT), EB2F(HMZ), EB2(HMZ), HMY(EB2M), HMZ(EB2), ZMZ(EBO)

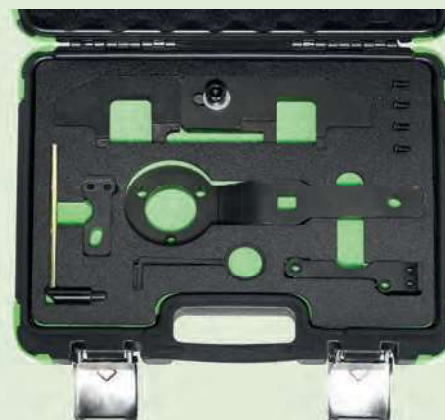

53313

139,00€

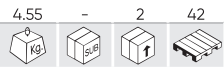

KIT DE BLOQUEIO CITROEN/PEUGEOT

MARCAS	CITROËN: BERLINGO 2008-2011, C2 2003-2010, C-ELYSEE 2012-2016, C3 PLURIEL 2003-2010, C4 2004-2011, NEMO 2008-2015, XSARA 2000-2005 PEUGEOT: 106 1998-2003, 206 1998-2009, 207 2006-2013, 306 1998-2003, 307 2000-2008, 1007 2005-2010, PARTNER 1998-2011, BIPPER 2008-2015
FERRAMENTAS OEM	EN-52137, EN-52141, KM-6349, MOT.1430, MOT1430, MOT1436, 0123-RZ, 0132AB, 0132AJ1, 0132AJ2, 0132AK, 0132Q, 0132QY, 0132QZ, 0132R, 0153AA, 0153AB, 0153AK, 0153AL, 0153G, 0153ZY, 0178D, 0187B, 0188K, 0188M, 0188Q1, 0189B, 0189K, 0194A, 0194B, 077440010400, 0991958120, 119790, 132Z, 1.860.617.000, 1870900100, 2000023200, 21-260, 21263, 3031277, 303-732, 303735, 4200TA, 4507TA, 4507TB, 4527TS2, 4533TAC, 4533TAC2, 4533TAD, 49JE02018, 49JE02021, 5711TD, 607589011500, 7014TN, 7099TM, 976727, 99360608, 9997122, 9997169
CÓDIGOS DE MOTOR	EC5 (NFP), ET3J4 (KFU), KDX (TU3MC), KFT (TU3A), KFU (ET3J4), KFV (TU3A), KFW (TU3JP), KFX (TU3JP), NFP (EC5), FR (TU5JP4B), NFS (TU5JP4S), NFU (TU5JP4), TU3A (KFT), TU3A (KFV), TU3A (KFW), TU3JP (KFV), TU3JP (KFW), TU3JP (KFX), TU3M (KDX), TU5JP4 (NFU), TU5JP4B (NFR)



53314

98,00€

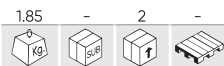

KIT DE BLOQUEIO CITROEN/PEUGEOT 1.8, 2.0

MARCAS	PSA: 1.8 16V, 2.0 16V
FERRAMENTAS OEM	0132AB, 0153J, 0178D, 0178E, 0188AH, 0188J, 0188JJ2, 0188J2, 0188M, 0189B, 0189R, 0189S1, 0189S2, 0194A, 0194B, 5711TE, 7017TR
CÓDIGOS DE MOTOR	EW10ABE4(RFH), EW10A(RFJ), EW10J4S(RFK), EW7A(6FY), RFH, RFJ, RFK, 6FY



53876

64,00€

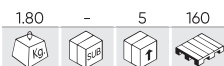

KIT DE BLOQUEIO PSA 1.0, 1.2 VTI

MARCAS	CITROËN: BERLINGO III 2014-2018, BERLINGO IV 2018-ON, C1 II 2014-2018, C3 III 2012-2017, C3 IV 2016-ON, C3 PICASSO 2014-2017, C3 AIRCROSS 2017-ON, C4 II 2014-2018, C4 CACTUS 2014-2018, C4 CACTUS 2017-2021, C-ELYSEE 2012-ON, C4 PICASSO/GRAND PICASSO II 201 DS: 3 2015-2016, 3 II 2016-2020, 3 CROSSBACK 2019-ON, 4 2015-2015, 4 II 2015-2019, 4 CROSSBACK 2015-2019, 7 CROSSBACK 2018-ON PEUGEOT: 108 2014-2018, 208 2012-2019, 208 II 2019-ON, 301 2012-2020, 308 2013-ON, 508 2019-ON, 2008 2013-2020, 2008 II 2020-ON, 3008 2014-2016, 3008 II 2016-ON, 5008 2014-2017, 5008 II 2017-ON, PARTNERIII 2014-2018, PARTNERIV 2018-ON, RIFTER 2018-ON TOYOTA: AYGO 2015-2018 VAUXHALL/OPEL: COMBO-E 2018-ON, CORSA-F 2019-ON, CROSSLAND X 2017-2021, GRANDLAND X 2017-ON
FERRAMENTAS OEM	EN-52127-1, EN-52127-2, EN-52588, 0109 2B, 0109-2A, 0197-N
CÓDIGOS DE MOTOR	0132AB, 0153J, 0178D, 0178E, 0188AH, 0188J, 0188JJ2, 0188J2, 0188M, 0189B, 0189R, 0189S1, 0189S2, 0194A, 0194B, 5711TE, 7017TR



54288

72,50€

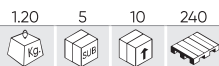

SET DISTRIBUȚIE PE PSA 1.2 GDI PURETECH

MARCAS	<p>CITROËN: BERLINGO 2014-ON, C3/PICASSO 2012-2017, C3/AIRCROSS 2016-ON, C4/CACTUS 2014-ON, C4 PICASSO/GRAND PICASSOII 2015-2018, C4 SPACETOURER/GRAND SPACETOURER 2018-ON, C5 AIRCROSS 2019-ON, DS3/DS3 CABRIO 2013-2015, DS4 2014-2015</p> <p>DS: DS 3/CROSSBACK 2015-ON, DS 4/CROSSBACK 2015-2019, DS 7/CROSSBACK 2018-2022</p> <p>PEUGEOT: 208 2012-ON, 308 2013-2021, 508 2019-ON, 2008 2013-ON, 3008 2014-ON, 5008 2014-ON, PARTNER 2014-ON, RIFTER 2018-ON</p> <p>VAUXHALL/OPEL: COMBO-E 2018-ON, CORSA-F 2019-ON, CROSSLAND X 2017-ON, GRANDLAND X2017-ON</p>
FERRAMENTAS OEM	EN-52127-2, EN-52588, J-0109-2C, J-0109-2D, 0109-2B, 0109-2C, 0109-2D, 0197-N
CÓDIGOS DE MOTOR	B12XHL, B12XHT, D12XHL, D12XHT, EBO, EBOF, EB2ADT, EB2ADTD, EB2ADTS, EB2ADTSM, EB2ADTX, EB2ADTXM, EB2DT, EB2DTM, EB2DTS, EB2DTS, EB2DTS, EB2DTS, EB2DTS, EB2FA, EB2FAD, F12XHT, HMR, HMT, HMU, HN, HNJ, HNK, HNL, HNN, HNP, HNS, HNT, HNV, HNW, HNX, HNY, HNZ



54323

119,00€



KIT DE BLOQUEIO PSA 1.0, 1.2 VTI, 1.2 GDI PURETECH

MARCAS	<p>CITROËN: C1 II (2014-2018), C3 III (2012-2017), C3 IV (2016-2018), C4 CACTUS (2014-2020), C4 AIRCROSS (2018-2020), C-ELYSEE (2012-2018), DS3 (2012-2018), BERLINGO IV (2018-2020),</p> <p>GM: CROSSLAND X (2017-2020), COMBO E (2018-2020), GRANDLAND X (2017-2020)</p> <p>PEUGEOT: 108 (2014-2018), 208 (2012-2021), 2008 (2013-2021), 301 (2012-2020), 308 (2013-2021), 3008 (2016-2021), 508 (2019-2021), 5008 (2014-2021), PARTNER III (2015-2018), PARTNER IV (2018-2021), RIFTER (2019-2021)</p> <p>TOYOTA: AYGO (2014-2018).</p>
FERRAMENTAS OEM	EN-52127-1, EN-52127-2, G-0109-6, J-0109-2C, J-0109-2D, 0109 2B, 0109-2A21
CÓDIGOS DE MOTOR	B12XHL, B12XHT, D12XHL, D12XHT, EBO, EBOF, EB2, EB2ADT, EB2ADTD, EB2ADTS, EB2ADTSM, EB2ADTX, EB2ADTXM, EB2D, EB2DT, EB2DTM, EB2DTS, EB2DTS, EB2DTS, EB2FA, EB2FAD, EB2FB, EB2FD, EB2M, F12XHT, HMM, HMM, HMP, HMR, HMT, HMU, HMV, HMW, HMX, HMY, HMZ, HMO1, HNJ, HNK, HNL, HNN, HNP, HNS, HNT, HNV, HNW, HNX, HNY, HNZ, HNO2, HNO5, ZMZ, 1PP, YH01



16400

6,50€

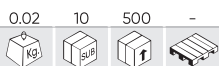

CALIBRAGEM DE VERIFICAȚAO DA CORREIA DENTADA PSA (REF.54288)

MARCAS	<p>CITROËN: CACTUS (14-20), C4 AIRCROSS (18-20), C-ELYSEE (12-18), DS3 (12-18), BERLINGO IV (18-20), C1 II (14-18), C3 III (12-17), C3 IV (16-18), C4</p> <p>GM: CROSSLAND X (17-20), COMBO E (18-20), GRANDLAND X (17-20)</p> <p>PEUGEOT: 108 (14-18), 208 (12-21), 2008 (13-21), 301 (12-20), 308 (13-21), 3008 (16-21), 508 (19-21), 5008 (14-21), PARTNER III (15-18) PARTNER IV (18-21) RIFTER (19-21)</p> <p>TOYOTA: AYGO (14-18)</p>
FERRAMENTAS OEM	EN-52809 G-0109-6
CÓDIGOS DE MOTOR	EB2ADJ, EB2ADS, EB2ADT, EB2ADTX, EB2DT, EB2DTM, EB2DTS, EB2DTS, EB2F, EB2FAD, EB2FB, EB2M, HMM EB2FAD, HMM EB2FAD, HMP EB2FB, HMR EB2FA, HMT EB2D, HMT EB2F, HMV EB2M, HMW EB2, HMX EB2F, HMY EB2M, HMZ EB2, HMZ EB2, HMZ EB2F, HMZ EB2FB, HMO1 1PP, HNK EB2ADT, HNN EB2ADTX, HNP EB2ADJ, HNS EB2ADS, HNV EB2DTM, HNW EB2DTS, HNW EB2DTS, HNY EB2DTS, HNZ EB2DT, 1PP



54433

18,00€

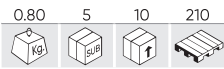

KIT DE BLOQUEIO PSA 1.0, 1.1, 1.2, 1.4, 1.6, 2.0

MARCAS	<p>CITROËN: BERLINGO/BERLINGO FIRST I/II 1999 - 2007, C4 2004 - 2011, C4 II 2010 - 2018, C4 PICASSO/GRAND PICASSO 2006 - 2015, C4 PICASSO/GRAND PICASSO II DS: 4 2015, 4 II 2015-2018, 4 CROSSBACK 2015-2018, 5 2015-2018, 7 CROSSBACK 2017-ON</p> <p>FIAT: SCUDDO 1999-2016, ULISSE 1999-2002</p> <p>MITSUBISHI: OUTLANDER 2007-2013</p> <p>PEUGEOT: 206 1999-2006, 306 1999-2002, 307 2001-2008, 307 CC 2005-2009, 308 2007-ON, 308 CC 2009-2015, 406 1999-2004, 407 2004-2011, 407 COUPE 2007-2012, 508 2011-2018, 607 2000-2011, 807 2005-2015, 3008 2009-2016, 3008 2016-ON, 4007 2007-2012, 5008 2009-</p> <p>TOYOTA: PROACE 2013-ON</p>	
FERRAMENTAS OEM	<p>EN-52137, KM-6349, MOT. 1430, MOT 1430, MOT 1436, M10 X 70MM, 0123-RZ, 0132AB, 0132AJ1, 0132AK, 0132Q, 0132QY, 0132QZ, 0132R, 0153AA, 0153AB, 0153AK, 0153G, 0153ZY, 0178D, 0187B, 0188K, 0189B, 0189K, 0194A, 0194B, 09919 58120, 1 870 900 100, 10MM PIN, 11 9 790, 132Z, 1.860.617.000, 21 263, 21-260, 3MM PIN, 303 735, 3031277, 303-732, 4507 TA, 4507 TB, 4527 TS2, 4533 TAD, 49 JE02 018, 49 JE02 021, 5711 TD, 607589011500, 7014 TN, 77440010400, 8MM DRILL BIT, 8MM PIN, 9767 27, 99360608, 999 7122, 999 7169</p>	
CÓDIGOS DE MOTOR	<p>AHH (DW10FC), AHJ (DW10FE), AHK (DW10FE), AHM (DW10FUE), AHN (DW10FUD), AHP (DW10FUC), AHR (DW10FD), AHS (DW10FD), AHV (DW10FD), AHW (DW10FC), AHX (DW10FD), AHY (DW10CE), AHZ (DW10CTED4), DW10ATED (RHS), DW10ATED (RHZ), DW10ATED4 (RHM), DW10ATED4 (RHW), DW10ATED4/L4 (RHT), DW10BTED (RHX), DW10BTED4 (RHF), DW10BTED4 (RHL), DW10BTED4 (RHR), DW10CD (AHZ), DW10CE (AHY), DW10CTED4 (RHC), DW10CTED4 (RHD), DW10CTED4 (RHE), DW10CTED4 (RHH), DW10FC (AHH), DW10FC (AHT), DW10FC (AHW), DW10FC (EHZ), DW10FD (AHR), DW10FD (AHS), DW10FD (AHV), DW10FD (AHX), DW10FE (AHJ), DW10FE (AHK), DW10FUC (AHP), DW10FUD (AHN), DW10FUE (AHM), DW10TD (RHY), DW10UTD (RHV), DW10UTED4 (RHG), DW10UTED4 (RHK), DW12ATED (4HX), DW12ATED (4HZ), DW12BTED4 (4HP), DW12BTED4 (4HR), DW12BTED4 (4HS), DW12BTED4 (4HT), DW12CTED4 (4HL), DW12MTED4 (4HK), DW12MTED4 (4HN), DW12RUC (4HC), DW12RUD (4HB), DW12RUE (4HA), DW12TED4/L4 (4HW), DW12UTED (4HY), EHZ (DW10FC), RHB (DW10CTED4), RHC (DW10CTED4), RHD (DW10C), RHD (DW10CTED4), RHE (DW10CTED4), RHF (DW10BTED4), RHG (DW10UTED4), RHH (DW10C), RHH (DW10CTED4), RHJ (DW10BTED4), RHK (DW10UTED4), RHL (DW10BTED4), RHM (DW10ATED4), RHR (DW10BTED4), RHS (DW10ATED), RHT (DW10ATED4/L4), RHV (DW10UTD), RHW (DW10ATED4), RHW (DW10JATED4), RHX (DW10BTED/L3), RHY (DW10TD), RHZ (DW10ATED), RHZ (DW10ATED/L3), RHZ (DW10ATED), RH02 (DW10CTED4), 4HK, 4HK (DW12MTED4), 4HL (DW12CTED4), 4HN, 4HN (DW12MTED4), 4HP (DW12BTED4), 4HR (DW12BTED4), 4HS (DW12BTED4), 4HT (DW12BTED4), 4HW (DW12TED4/L4), 4HX (DW12TED4), 4WZ-FHV/DW10FC (AHW), 4WZ-FTV/DW10FD (AHX), 4WZ-FTV/DW10FE (AHJ), 4WZ-FTV/DW10FE (AHK)</p>	

54432

43,00€

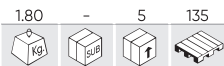

KIT DE BLOQUEIO MERCEDES PSA 2.7, 3.0 HDI

MARCAS	<p>CITROËN: C5 III 2007-2014, C6 2005-2009</p> <p>JAGUAR: S-TYPE 2004-2008, XF 2008-2020, XJ 2010-2020, XJ6 2005-2010, F-PACE 2016-2020</p> <p>LAND ROVER: DISCOVERY 2017-2018, DISCOVERY 3 2004-2009, DISCOVERY 4 2009-2017, RANGE ROVER 2012-2020, RANGE ROVER SPORT 2005-2020, RANGE ROVER VELAR 2017-2020</p> <p>PEUGEOT: 407 2004-2009, 407 COUPE 2006-2012, 607 2004-2011</p>	
FERRAMENTAS OEM	<p>0188K, 0195C, 0195H, 0195K, 303 11116, 303 11117, 303 1126, 303 1132</p>	
CÓDIGOS DE MOTOR	<p>AJ-V6D/306DT, DT17BTED4(UHZ), DT20C(X8C), DT20C(X8Z), D20CTED4(X8Z), UHZ, X8C, X8Z, 276DT, 276DT (7B/7G), 306DT, 7B, 7G</p>	



NOVO MOTOR DE BUSCA NA WEB PARA KITS DE FERRAMENTAS DE TEMPORIZAÇÃO DE MOTORES

Descubra a nossa nova ferramenta online: um novo localizador de kits para encontrar o que precisa!

Aceda ao nosso website e localize a secção de procura de kits de regulação no menu principal.

54213

19,80€

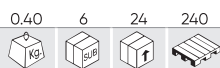

KIT DE BLOQUEIO DE DISTRIBUIÇÃO PARA ROVER/PEUGEOT/FORD/VOLVO 2.0, 2.2L D

MARCAS	<p>CITROËN: C4 (04-10), C5 II (04-10) FORD: S MAX 2.2 (08-10), GALAXY 2.2 (08-10), MONDEO 2.2, 2.0 (07-10) LAND ROVER: FREELANDER (06-10) PEUGEOT: 807 (05-11), 407 (05-11), 607 (05-09) VOLVO: S40 (03-10), V50 (06-10), C70 (06-10), C30 (06-10), V70 (07-10)</p>
FERRAMENTAS OEM	0188.F, 0188.M, 0188.X, 303-1059, 303-1270, 303-1272, 303-1277, 303-393A, 303-393-01, 303-735, 999-7119, 999-7120, 999-7121, 999-7122
CÓDIGOS DE MOTOR	AZBA, AZBC, AZWA, DW10BTED4, DW10UTED4, DW12BTED4, D420T, QXBA, QXBB, QXWA, QXWB, Q4BA, RHK, RHR, 224DT, 4HP, 4HR, 4HS, 4HT



54462

51,00€

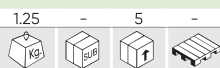

ALINHADOR DO EIXO DE BALANCEAMENTO - FORD 2.2 DIESEL

MARCAS	<p>CITROËN: C5, C5 II, C5 III, C6, C8, C-CROSSE HDI (200-2015) ENGINE CODES: 4HX (DW12CTED4), 4HP (DW12BTED4), 4HX (DW12TED4), 4HW (DW12TED4/L4) FORD GALAXY, MONDEO, S-MAX, TDCI, TCI (2008-2015) ENGINE CODES: KNBB, KNBA, KNWA, Q4BA LAND ROVER: DISCOVERY, DISCOVERY SPORT, FREELANDER 2, ED4, TD4, TD4E (2009-2015) ENGINE CODES: 224DT, DW12CTED4/224DT, DW12BTED4/224DT MITSUBISHI: OUTLANDER DI-D, DI-DC (2007-2013) ENGINE CODES: 4HK, 4HN PEUGEOT: 4007, 407, 607, 807, 406, 508, 607, HDI, GT HDI (2000-2015) ENGINE CODES: DW12MTED4 (4HK), DW12MTED4 (4HN), DW12BTED4 (4HP), DW12BTED4 (4HR), DW12BTED4 (4HT), DW12TED4/L4 (4HW), DW12BTED4 (4HS), DW12ATED (4HZ), DW12ATED4 (4HX), DW12ATED (4HZ), DW1</p>
FERRAMENTAS OEM	303-1328 303-1329 303-1330
CÓDIGOS DE MOTOR	DW12ATED (4HZ), DW12ATED4 (4HX), DW12BTED4 (4HP), DW12BTED4 (4HR), DW12BTED4 (4HS), DW12BTED4 (4HT), DW12BTED4/224DT, DW12CTED4 (4HL), DW12CTED4/224DT, DW12MTED4 (4HK), DW12MTED4 (4HN), DW12TED4/L4 (4HW), KNBA, KNBB, KNWA, Q4BA, 224DT, HK, 4HN, 4HP (DW12BTED4), 4HW(DW12TED4/L4), 4HX (DW12CTED4), 4HX(DW12TED4)



53318

24,00€

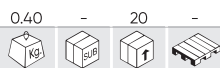

EXTRATOR DE PINHÃO DE EIXO DO COMANDO FORD / PSA

MARCAS	<p>CITROËN: C3 III (1015), DS3 (1015), XSARA II (0015), XSARA PICASSO (9910), C4 (0411), C4 II (1115), C4 PICASSO/GRAND PICASSO (1015), C4 AIR CROSS (1215), C5 (0005), C5 II (0408), C5 III (1015), DS4 (1115), XANTIA (9801), SYNERGIE/EVASION (9903), C8 (0215) FORD: 1.4TDCI, 1.6TDCI, 1.8DI/TDDI/TDCI, 2.0TDCI (BELT), FIESTA, COURIER, FUSION, FOCUS/C-MAX, MONDEO, S-MAX, GALAXY, TOURNEO, CONNECT, TRANSIT CONNECT. MAZDA: 2, 3 PEUGEOT: 107 (0510), 1007 (0510), 206 (0109), 206CC (0507), 208 (1214), 306 (9902), 307 (0106), 307CC (0509), 308 (1114), 308CC (0914), 407 (0811), 407 COUPE (0712), 508 (1114), RCZ (1014), 2008 (1314), 3008 (1014), 4008 (1214), 5008 (1014), BIPPER (0810)</p>
FERRAMENTAS OEM	21-229, 303-651
CÓDIGOS DE MOTOR	AZBA, AZBC, AZWA, AZWC, BHDA, BHDB, BHPA, C9DA, C9DB, C9DC, DC4TED, DV4C, DV4DT, F6JA, F6JB, F6JC, G6DA, G6DB, G6DC, G6DD, G6DE, G6DF, G6DG, HHJD, KHBA, KLBA, LPBA, QXBA, QXBB, RTN, RTP, RTQ, TXBA, TXDA, TXDB, TXWA, TYBA, TYDA, TYWA, UFBA, UFDB, UFWA, UKBA, UKBB, UKDB, UKWA, 8HP, 8HS, 8HX, 8HZ



54467

181,50€

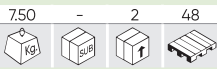

KIT DE ASPIRAÇÃO GASOLINA-VOLVO 1.5/2.0

MARCAS	VOLVO: S60, V40, V40 CROSSCOUNTRY, V60, V60 CROSSCOUNTRY, 70, XC60, XC70
FERRAMENTAS OEM	19997495 9997490 9997493 9997496 9997497
CÓDIGOS DE MOTOR	VOLVO B4204 ENGINE (8-SPEED TRANSMISSION)



54466

109,50€

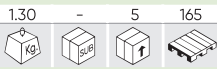

KIT DE ASPIRAÇÃO DIESEL-VOLVO 2.0D

MARCAS	VOLVO: S60, S80, S90, V40, V60, V70, V90, XC40, XC60, XC70, XC90
FERRAMENTAS OEM	999 7233 999 7495
CÓDIGOS DE MOTOR	D4204T11, D4204T12, D4204T13, D4204T14, D4204T16, D4204T20, D4204T23, D4204T4, D4204T5, D4204T6, D4204T7, D4204T8, D4204T9



53293

134,00€

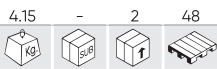

KIT DE BLOQUEIO FORD

MARCAS	DIESEL: 1.4, 1.6, 1.8, 2.0 PETROL: 1.25, 1.4, 1.6, 1.6 VCT-TI, 1.7, 1.8, 2.0
FERRAMENTAS OEM	3031054, 3031059, 3031097, 303193 21104, 303376 21162B, 30339301, 303651 21229, 303734 21262, 303748



CÓDIGOS DE MOTOR	ALDA, AOBA, AOBC, AODA, AODB, AODE, AOWA, AOWB, ASDA, ASDB, AZBA, AZBC, AZWA, AZWC, BHDA, BHDB, BHPA, CDBB, CGBA, CGBB, CHBA, CHBB, CJBA, CJBB, CSDA, CSDB, C9DA, C9DB, C9DC, DHA, DHB, DHC, DHD, DHE, DHF, DHG, EDBA, EDBB, EDBC, EDBD, EDDB, EDDC, EDDD, EDDF, EYDB, EYDC, EYDD, EYDE, EYDF, EYDG, EYDI, EYDJ, EYDL, EYPA, EYPC, FFBA, FFDA, FFWA, FHA, FHB, FHD, FHE, FHF, FUJA, FUJB, FXDA, FXDB, FXDC, FXDD, FXJA, FXJB, FXJC, F6JA, F6JB, F6JC, F6JD, F8JA, F8JB, F9DA, F9DB, GPDA, GZ, GZFA, GZFB, GZFC, G6DA, G6DB, G6DC, G6DD, G6DE, G6DF, G6DG, G8DA, G8DB, G8DD, HCPA, HCPB, HHDA, HHDB, HHJA, HHJB, HHJC, HHJD, HHJE, HHJF, HMDA, HXDA, HXDB, HXJA, HXJB, IQDA, IQDB, IQDC, IQDE, IQJA, IQJC, IQJE, IXDA, JQDA, JQDB, JQMA, JTBA, JTDA, JTDB, JTWA, JTWB, KHBA, KKDA, KKDB, KLBA, KLWA, KNBA, KVJA, LPBA, MUDA, MUDD, M7JA, M7JB, M8DA, M8DB, M8MD, M9DA, M9DB, NGA, NGB, NGC, NGD, N4JB, PNBA, PNDA, PNDD, P7PA, P9PA, P9PB, QQDA, QQDB, QQDC, QQDD, QXBA, QXBB, QXWA, QXWB, QYBA, QYWA, Q4BA, Q7DA, RFN, RHBA, RKA, RKB, RKC, RKF, RKH, RKJ, RKK, RTJA, RTJB, RTN, RTP, RTQ, RWPA, RWPC, R2PA, R3PA, SEBA, SEWA, SIDA, SNJA, SNJB, SNJC, SNJD, SPJA, SPJC, SPJD, SPJE, STJA, STJB, STJC, STJD, SYDA, TBBA, TBBD, TBWA, TBWB, TXBA, TXDA, TXDB, TXMA, TXWA, TYBA, TYDA, TYWA, TZJA, TZJB, T7DB, T8DA, UFBA, UFDA, UFDB, UFMA, UFWA, UKBA, UKBB, UKDA, UKDB, UKMA, UKWA, UTJA, XTDB, YF
------------------	---

54594

99,00€

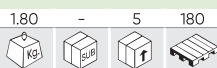

KIT DE CORREIA DE DISTRIBUIÇÃO FORD GASOLINA 1.5 ECOBOOST

MARCAS	FORD: FIESTA DURATEC 2018, FOCUS ECOBOOST 2018, FOCUS ST ECOBOOST 2018, KUGA 1.5L ECOBOOST (I3) 2019
FERRAMENTAS OEM	303-1643, 303-1645, 303-1649
CÓDIGOS DE MOTOR	YZDA, YZJA, Y1DA, Y2DA



54592

94,50€

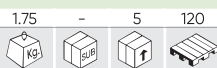

KIT DE CORREIA DE DISTRIBUIÇÃO FORD GASOLINA ECOBOOST

MARCAS	FORD (FOX ENGINE) MODELS: C-MAX (FROM 2017) FIESTA (FROM 2017), FOCUS (FROM 2018), PUMA (FROM 2019), TRANSIT CONNECT (FROM 2017)
FERRAMENTAS OEM	0132AB, 1.860.617.000, 2 450 487, 23-019, 303-160, 303-1603, 303-1643, 303-1661, 4527-TS2, 999-7169
CÓDIGOS DE MOTOR	1.0 EcoBoost: B3DA, B7DA, B7JA, MOJA, MOJB 1.0 EcoBoost Hybrid: B7JB, BZJA, B7DC, M0DC 1.0 SCTI EcoBoost: B3GA, B3GB



53294

119,00€

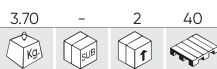

KIT DE BLOQUEIO FORD MAZDA

MARCAS	CITROËN: C1 (05-10), C2 (03-10), C3 I/II (02-10), C3 III (10-15), C3 PLURIEL (04-10), C3 PICASSO (09-12), C4 (04-11), C4 II(11-15), C4 PICASSO (06-12), C4 GRAND PICASSO (10-12), DS3 (09-12), DS4 (11-12), DS5 (12-15), C5 II (04-08), C5 III (04-12), XSARA II FORD: COURIER (00-02), C-MAX (03-10), FIESTA (02-11), FOCUS (98-11), FUSION (02-11), GALAXY (06-10), KUGA (06-10), MONDEO (07-10), S-MAX (06-10), TOURNEO CONNECT (02-13), TRANSIT CONNECT (02-13) MAZDA: 2 (02-15), 3 (09-14) PEUGEOT: BIPPER (08-10) DISPATCH/ JUMPY III (07-12) EXPERT III (07-12) NEMO (08-10) PARTNER I/II (05-11) PARTNER III (08-16) 107 (05-10) 1007 (05-10) 206 (01-12) 206+ (09-13) 206 CC (05-07) 207 (06-13) 207 CC (07-15) 208 (11-15) 307 (01-08) 308 (07-15) 308
FERRAMENTAS OEM	0194-A, 0194B, 0194-C, 303-1059, 303-193, 303-376B, 303-393, 303-393/01, 303-651, 303-732, 303-734, 303-735
CÓDIGOS DE MOTOR	AZWA, BHPA, C9DA/B, C9DC, DVTED4 (8HV), DVTED4 (9HV), DV4C (8HP), DV4C (8HR), DV4TD (8HT), DV4TD (8HW), DV4TD (8HX), DV4TD (8HZ), DV4TED (8HS), DV4TED4 (8HX), DV4TED4 (8HY), DV6 (9HR), DV6AT (9HX), DV6ATED (9HY), DV6ATED4 (9HX), DV6AUTED4 (9HX), DV6BTED4 (9HT), DV6BTED4 (9HW), DV6BUTED4 (9HT), DV6C (BHX), DV6C (BHZ), DV6C (9HD), DV6C (9HL), DV6C (9HR), DV6CATED (9HX), DV6CTED (9HC), DV6D (9HP), DV6DTED (9HF), DV6DTED (9HJ), DV6DTED (9HP), DV6ETED (9HN), DV6TED (9HD), DV6TED (9HP), DV6TED4 (9HV), DV6TED4 (9HW), DV6TED4 (9HX), DV6TED4 (9HY), DV6TED4 (9HZ), DV6TED4B, DV6TED4B (9HV), DV6TED4BU (9HS), DV6UTED4 (9HU), DV6UTED4 (9HX), FFBA, F6JA, F6JB, F6JC, G6DA, G6DB, G6DC, G8DA, G8DB, HCBP, HCPA, HHDA, HHDB, HHJA, HHJB, KKDA, MZ-CD, P7PA, P9PA, QXWA, QXWB, RHE, RTN, RTQ, RWPA, R2PA, R3PA, Y6



53295

77,00€

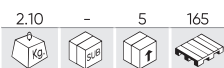

KIT DE BLOQUEIO FORD 1,8TDDI, TDCI

MARCAS	C-MAX (07-10), COURIER (00-02), FIESTA (00-02), FOCUS (98-11), FOCUS C-MAX (03-07), GALAXY (06-10), MONDEO (07-10), S-MAX (06-14), TOURNEO CONNECT (02-13), TRANSIT CONNECT (02-13)
FERRAMENTAS OEM	303193(21104), 303376(21162), 303393(21168), 303652(21230), 310095(23067)
CÓDIGOS DE MOTOR	BHDA, BHDB, BHPA, C9DA, C9DB, C9DC, FFBA, FFDA, FFWA, F9DA, F9DB, HCPA, HCPB, KHBA, KKDA, KKDB, P7PA, P9PA, P9PB, QYBA, QYWA, RTN, RTP, RTQ, RWPA, RWPC, R2PA, R3PA



53296

60,00€

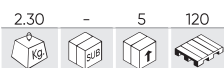

KIT DE BLOQUEIO PARA BOMBA DE INJEÇÃO FORD/JAGUAR DURATORQ

MARCAS	1.4 TDCI 1.4HDI 8V, 1.4 HDI 16V, 1.5 TDCI / ECONETIC, 1.5 BLUEHDI, 1.5 ECOBLUE TDCI, 1.6 HDI 16V, 1.6 HDI 8V TURBO, 1.6 BLUE HDI
FERRAMENTAS OEM	EN-52138, KM-6349, 0132AB, 0132AJ1, 0178D, 0187B, 0189B, 0194A, 0194B, 0194C, 77440010400, 09919 58120, 11 9 790, 1860617000, 21 234, 21 262, 21 263, 21-260, 303 675, 303 734, 303 735, 3031277, 303-732, 4527 TS2, 49 JE02 018, 49 JE02 020, 49 JE02 021, 5711 TD, 99360608, 999 7121, 999 7169
CÓDIGOS DE MOTOR	ABFA, BG, CYFA, CYFB, CYFC, DOFA, DRFA, DRFB, DRFC, D2FA, D2FB, D3FA, D4FA, D5BA, D6BA, F1FA, FMBA, FMBB, FXFA, F3FA, F4FA, HJBA, HJBB, HJBC, HJBE, H9FA, H9FB, H9FD, JXFA, JXFC, N7BA, N7BB, PGFA, PGFB, PHFA, PHFC, P22DTE (4HM), P22DTE (4HU), P22DTE (4HV), P8FA, P8FB, QJBA, QJBA (BG), QJBB, QJBC, QJBD, QVFA, QWFA, SRFA, SRFB, SRFC, SRFD, SRFE, Td4244DT, UHFA, 4HM, 4HU, 4HV, 424.2



54421

52,00€

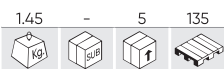

INSTALADOR DE CORREIA AUXILIAR FORD/VOLVO 1.4 1.6

MARCAS	FORD: FOCUS, C-MAX, MONDEO VOLVO: S40, C30, V50
FERRAMENTAS OEM	303-1179
CÓDIGOS DE MOTOR	B4164S3, CH16HDEZ, C12HM7AD, C12LM7AA, C14HDEZ, C14HHDCB, C16HHDEY, FUJA, FXJA, FYJA, ZH12FUJA, ZH12FUJB, ZH12M7JB, ZH14ASDA, ZH14FXDA, ZH14FXDB, ZH14FXDC, ZH14FXDD, ZH14FXJA, ZH14FXJB, ZH16FYDA, ZH16FYDB, ZH16FYDC, ZH16FYDD, ZH16FYJA, ZH16HWDA, ZH16HXDA, ZJ16FYJB, 16HDEZ



54420

102,00€

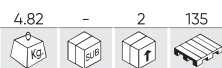

CONJUNTO DE AJUSTE DE COMBUSTÍVEL – FORD/VOLVO 2.5 (EURO 4)

MARCAS	FORD: FOCUS 2.5 RS / ST, MONDEO 2.5, S-MAX 2.5, GALAXY 2.5 ST (2005-) VOLVO: C30 (06-10), C70 (98-10), S40 (96-10), S60 (00-09), S70 (97-07), S80 (98-06), V40 (96-10), V50 (04-10), V70 (97-07), XC70 (02-07), XC90 (02-10)
FERRAMENTAS OEM	303-1178, 303-1179, 303-1182, 303-1183, 999 5433, 999 5451, 999 5452
CÓDIGOS DE MOTOR	B4164S, B4164S2, B4184S, B4184S10, B4184S2, B4184S3, B4184S9, B4194T, B4194T2, B4204S, B4204S2, B4204T, B4204T2, B4204T3, B4204T5, B5234FS, B5234T3, B5234T4, B5234T5, B5234T6, B5234T7, B5234T8, B5234T9, B5244FS, B5244SG, B5244SG2, B5244S2, B5244S4, B5244S5, B5244S7, B5244T, B5244T2, B5244T3, B5244T4, B5244T5, B5244T7, B5254T10, B5254T11, B5254T2, B5254T3, B5254T4, B5254T5, B5254T6, B5254T7, B5254T8, HUBA, HUWA, HYBA, HYDA, HYDC, JZDA



54424

64,50€

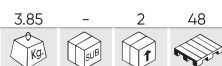

KIT DE BLOQUEIO FORD 2.0 ECOBOOST

MARCAS	FORD: FOCUS 2011-2018, GALAXY 2010-2018, MONDEO 2010-2018, S-MAX 2010-2018
FERRAMENTAS OEM	2MM TENSIONER, 303-1504, 303-1521, 303-1565, 303-1595, 303-1600, 303-748
CÓDIGOS DE MOTOR	MGDA, R9CB, R9CD, R9CF, R9CH, R9DA, R9DB, R9DC, R9DD, TNBA, TNBB, TNCC, TNCD, TNCF, TNWA, TNWB, TPBA, TPWA, TVDA, XQDA



53324

12,50€

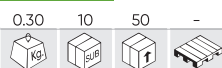

KIT DE BLOQUEIO FORD / MAZDA / VOLVO

MARCAS	FORD: COUGAR 1998-2001, FIESTA 1995-2017, FOCUS 1998-2014, FUSION 2002-2012, GALAXY 2006-2015, C-MAX 2003-2010, B-MAX 2012-2018, S-MAX 2006-2015, MONDEO 1998-2015, TOURNEO CONNECT 2002-2006, TRANSIT CONNECT 2002-2006, TRANSIT 2006-2011 MAZDA: I21 1995-2000, 2 2002-2007, 3 2003-2014, 5 2005-2015, 6 2002-2013, MPV 2002-2005, MX-5 2005-2015, TRIBUTE 2004-2006 VOLVO: C30 2006-2013, S40 2004-2012, S80 2007-2011, V50 2004-2012, V70 2007-2011
FERRAMENTAS OEM	EN-51418, JE01054, JE01061, JE02061, JLR30374, MB995208, T03006, T10115, T4031, 0198-J, 114120, 21210, 21259, 303-1054, 3031097, 303376, 303376B, 303507, 303748, 49JE01054, 49JE01061, 9997151, 9997152, 9997406, 9997429
CÓDIGOS DE MOTOR	ALDA, AOBA, AOBC, AODA, AODB, AODE, AOWA, AOWB, ASDA, ASDB, B4164 S3, B4184 S11, B4184 S8, B4204 S3, B4204 S4, CDBB, CFBA, CGBA, CGBB, CHBA, CHBB, CJBA, CJBB, CSDA, CSDB, DHA, DHB, DHC, DHD, DHE, DHF, DHG, EDDB, EDBB, EDBC, EDBD, EDDB, EDDC, EDDD, EDDF, EYDB, EYDC, EYDD, EYDE, EYDF, EYDG, EYDI, EYDJ, EYDL, EYPA, EYPC, FHA, FHD, FHE, FHF, FUJA, FUJB, FXDA, FXDB, FXDC, FXDD, FXJA, FXJB, FXJC, FYDA, FYDB, FYDC, FYDD, FYDH, FYJA, FYJB, FYJC, F8JA, F8JB, GZFA, GZFB, GZFC, HMDA, HWDA, HWDB, LF, LIF, LIJ, LIL, LIN, LIQ, LIT, LIV, L1W, L3, L8, M7JA, M7JB, NGA, NGB, NGC, NGD, N4JB, QQDA, QQDB, QQDC, QQDD, QQDE, Q7DA, RKA, RKB, RKF, RKH, RKJ, RKK, RTJA, RTJB, RTJC, RTJD, RTJE, SEBA, SEWA, SHDA, SHDB, SHDC, SNJA, SNJB, SNJC, SNJD, SPJA, SPJC, SPJD, SPJE, STJA, STJB, STJC, STJD, SYDA, TBBA, TBBB, TBWA, TBWB, UTJA



53653

207,00€

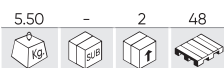

KIT DE BLOQUEIO FORD

MARCAS	FORD: B-MAX 2012-2018, C-MAX/GRAND C-MAX 2012-2020, ECOSPORT 2013-ON, FIESTA/ FIESTA ACTIVE 2013-ON, FOCUS/FOCUS ACTIVE 2012-ON, MONDEO 2015-2018, TOURNEO CONNECT 2014-ON, GRAND TOURNEO CONNECT 2013-2018, TRANSIT CONNECT 2014-ON, TRANSIT COURIER 2014-2019
FERRAMENTAS OEM	303-1054, 303-1602, 303-1604, 303-1605, 303-1606, 303-732, 503-393A
CÓDIGOS DE MOTOR	M1CA, M1CB, M1DA, M1DC, M1DD, M1DH, M1JA, M1JC, M1JE, M1JH, M1JJ, M1JL, M1JM, M1JP, M1JU, M2DA, M2DB, M2DC, M2GA, M2GB, P4JA, P4JB, P4JC, P4JD, QOJA, QOJC, SFCA, SFCB, SFCC, SFCD, SFDA, SFDB, SFJA, SFJB, SFJC, SFJD, SFJE, SFJH, SFJJ, SFJK, SFJL, SFJN, SFJP, XMJA, XMJB, XMJC, XMJD, XPJA, XPJB, XPJC, XPJD, XYJA, XYJB, XYJC, XYJD, XYJE, YYJA, YYJB, YYJC, YYJD, YYJE, YYJF, YYJG



54201

37,60€

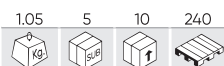

CONJUNTO DE FERRAMENTAS DE REGULAÇÃO DO MOTOR FORD

MARCAS	C-MAX(07 - 10), C-MAX/GRAND C-MAX(10-18), FIESTA(08-18), FOCUS/ FOCUS C-MAX(04-11), FOCUS(11-18), MONDEO(07-15)
FERRAMENTAS OEM	MOT 1430, 0132AJ1, 0187B, 0188M, 0188X, 0189B, 0194B, 21-259, 21-263, 303-1054, 303-1059, 303-1097, 303-1270, 303-1277, 303-735, 303-748, 999 7122, 999-7121, 999-7152
CÓDIGOS DE MOTOR	G6DA, G6DB, G6DC, HXDA, YSKD



54204

124,00€

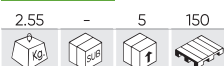

KIT DE BLOQUEIO DE DISTRIBUIÇÃO PARA FORD 2.0 ECOBLUE

MARCAS	EDGE (2018-21), FOCUS ACTIVE (2019-ON), FOCUS (2018 - ON), GALAXY (2018-21), KUGA (2019 - ON), MONDEO (2019-21), RANGER (2019-ON), S-MAX (2018-21), TOURNEO CUSTOM (2016 - ON), TRANSIT CUSTOM (2016-ON), TRANSIT (2016-ON)
FERRAMENTAS OEM	303-1637, 303-1643, 303-1650
CÓDIGOS DE MOTOR	BCCC, YLCB, YLDA, YLFA, YLFB, YLFS, YLF6, YLRA, YLR6, YMCA, YMFA, YMFB, YMFS, YMF6, YMHA, YMRA, YNCA, YNFA, YNFB, YNFS, YNF6, YNRA, YNR6

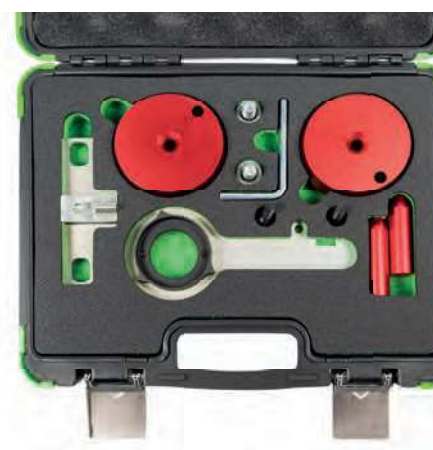

54208

76,00€

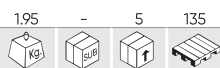

KIT DE BLOQUEIO DE DISTRIBUIÇÃO PARA FORD 2.0 ECO BOOST SCTI, TI-VCT

MARCAS	2.0 ECO BOOST FOCUS, GALAXY, MONDEO, S-MAX
FERRAMENTAS OEM	3031504, 3031521, 3031565, 303748
CÓDIGOS DE MOTOR	MGDA, R9CB, R9CD, R9CF, R9CI, R9DA, R9DB, R9DC, R9DD, TNBA, TNBB, TNCC, TNCD, TNCF, TNWA, TNWB, TPBA, TPWA, XQDA, YVDA



54209

29,70€

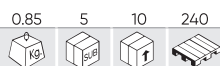

KIT DE BLOQUEIO DE DISTRIBUIÇÃO PARA FORD/MAZDA 2.2, 3.2 TDCI

MARCAS	FORD: TRANSIT, RANGER, EVEREST MAZDA: BT-50
FERRAMENTAS OEM	3031587, 303675/21-234, 303698/21-251
CÓDIGOS DE MOTOR	ABFA, BG, CVFF, CVF5, CVRB, CVR5, CYFA, CYFB, CYFC, CYFF, CYFG, CYF5, CYRA, CYRB, CYR5, DOFA, DRFA, DRFB, DRFC, DRFF, DRFG, DRF5, DRRR, DRRB, DRR5, D2FA, D2FB, D3FA, D4FA, D5BA, D6BA, F1FA, FMBA, FMBB, FXFA, F3FA, F4FA, GBVAJ, GBVAJPF, GBVAJQJ, GBVAJQW, HJBA, HJBB, HJBE, H9FA, H9FB, H9FD, ID4/DT224, JXFA, JXFC, MZ-CD, N7BA, N7BB, PD2 4P, PGFA, PGFB, PHFA, PHFC, P22DTE, P8FA, P8FB, QJBA, QJBA BG, QJBB, QJBC, QJBD, QVFA, QWFA, QW2R, SAFA, SAFB, SA2R, SA2S, SA2W, SRFA, SRFB, SRFC, SRFD, SRFE, UHFA, UHFB, UHR5, USRA, USRB, USR6, UYR6, ZSD 424, 244DT, 4HG, 4HH, 4HJ, 4HM, 4HU, 4HV, 4H03, 6B



54223

149,00€



FERRAMENTA DE BLOQUEIO DE ÁRVORE DE CAMAS PARA FORD 1.5T

MARCAS	FORD: 1.5L DURATEC, ECOSPORT, FIESTA, FOCUS
FERRAMENTAS OEM	303-1639, 303-1643, 303-1647, 303-1648
CÓDIGOS DE MOTOR	DURATEC, SIGMA, UEJB



54224

64,50€

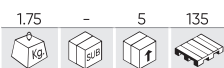

KIT DE INSTALAÇÃO/REMOÇÃO DE BOMBA DE INJEÇÃO PARA FORD 2.0

MARCAS	TRANSIT (17-18), TOURNEO CUSTOM (16-18), TRANSIT CUSTOM (16-18) 2.0 ECOBLUE TDCI
FERRAMENTAS OEM	303-1635/1, 303-1635/2, 303-1635/3, 303-1635/6
CÓDIGOS DE MOTOR	BCCA, BCCB, BCCC, BCFB, BCRA, BC2X, BJFA, BJFB, BJFC, BJFD, BJRA, BJRB, BKFA, BKFB, BKFC, BKFD, BKRA, BKRB, BLFA, BLFB, BLFC, BLFD, BLHA, BLRA, BLRB, YLCA, YLCB, YLCC, YLDA, YLDC, YLFA, YLFB, YLFS, YLF6, YLRA, YLR6, YL2X, YMCA, YMCB, YMCC, YMDA, YMFA, YMFB, YMFS, YMF6, YMHA, YMRA, YMR6, YNCA, YNFA, YNFB, YNFS, YNF6, YNRA, YNR6, YN2X



54260

277,00€



KIT DE MULTIPLICADOR DE FORÇA 5:1 PARA MOTORES FORD ECOBOOST

MARCAS	FORD: B-MAX (2012-2018), C-MAX (2012-2018), ECOSPORT (2015-2019), FIESTA (2012-2019), FOCUS (2012-2018), GRAND C-MAX (2017-2018), GRAND TOURNEO CONNECT (2013-2018), MONDEO (2015-2018), TOURNEO COURIER (2014-2020), TRANSIT CONNECT (2013-2018), TRANSIT COURIER (2014-2020)
FERRAMENTAS OEM	303-1611, 303-1611-01, 303-1611-02
CÓDIGOS DE MOTOR	B3DA, B7DA, M1CA, M1CB, M1DA, M1DD, M1JA, M1JC, M1JE, M1JH, M1JJ, M2DA, M2DB, M2DC, M2GA, M2GB, P4JA, P4JB, P4JC, P4JD, SFCA, SFCB, SFCC, SFCD, SFDB, SFJA, SFJB, SFJC, SFJD, XMJA, XMJB, XMJC, XMJD, YYJA, YYJB



54463

140,00€



KIT DE CALÇOS DIESEL-JAGUAR/LAND ROVER 2.0D

MARCAS	JAGUAR: E PACE, F PACE, XE, XF LAND ROVER: DEFENDER, DISCOVERY, DISCOVERY SPORT, RANGE ROVER EVOQUE RANGE ROVER: SPORT, VELAR
FERRAMENTAS OEM	JLR-303-1625, JLR-303-1627, JLR-303-1630
CÓDIGOS DE MOTOR	AJ20 - 204DT, AJ20 - 204DTA, AJ200 - 204DTA, AJ200 - 204DTD, AJ200D, AJ200D - 204DT, AJ200D - 204DTA, 204DTA, 204DTD



54464

152,00€

6.00 - 2 40



KIT DE REBARBAÇÃO DE GASOLINA -JAGUAR/ LAND ROVER

MARCAS	JAGUAR: E-PACE, F-PACE, F-TYPE, XE, XF, XJ LAND ROVER: DEFENDER, DISCOVERY, DISCOVERY SPORT, RANGE ROVER, RANGE ROVER EVOQUE, RANGE ROVER SPORT, RANGE ROVER VELAR
FERRAMENTAS OEM	JLR-303-1625, JLR-303-1627, JLR-303-1630
CÓDIGOS DE MOTOR	AJ20 - PT204, AJ200 - PT204, AJ200P, PT204



54465

193,50€

1.20 - 2 48



KIT DE BLOQUEIO JAGUAR/LAND ROVER-3.0/5.0

MARCAS	JAGUAR: AJ133, F-TYPE, XF/XFR (X250), XJ/XJR (X351), XK/XKR (X150), X150 - XK (10MY), X250 - XF (10MY), X351 - XJ (10MY) LAND ROVER: DISCOVERY 4 (2009-2013), RANGE ROVER SPORT (2009-), RANGE ROVER (2009-2017)
FERRAMENTAS OEM	1303-1445, 303-1447, 303-1448, 303-1452, 303-1482
CÓDIGOS DE MOTOR	AJ133, XF/XFR (X250), XJ/XJR (X351), XK/XKR (X150), X150-XK, X250-XF, X351-XJ



53297

45,00€

1.20 - 10 -



KIT DE BLOQUEIO JAGUAR/LAND ROVER

MARCAS	JAGUAR: S-TYPE, XF, SJ6, XJ, F-PACE (2.7 - 3.0) LAND ROVER: DISCOVERY 3, DISCOVERY 4, DISCOVERY, RANGE ROVER, RANGE ROVER SPORT, RANGE ROVER VELAR (2.7 - 3.0)
FERRAMENTAS OEM	0195H, 03 1116, 303 1117, 303 1126, 303 1132
CÓDIGOS DE MOTOR	AJ-V6D, 276DT, 306DT, 7B, 7G



53298

91,00€

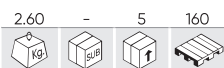

KIT DE BLOQUEIO LAND ROVER

MARCAS	LAND ROVER: DEFENDER 1990 - 1999, DISCOVERY 1990 - 1998, FREELANDER 1997 - 2000, RANGE ROVER 1993 - 1995, 110 1985 - 1990, 90 1985 - 1990
FERRAMENTAS OEM	LRT 12 058, LRT12060, LST 107, LST 129, LST 136, LST128, 12 058, 12 060, 18G 1458, 18G 1523, 18G 1524, 18G 1717A, 303 825, 303 863, 303 864, 303 868, 303 877, 303 896, 303851
CÓDIGOS DE MOTOR	12J, 19L, 20T2N, 20T4



54422

140,00€



KIT DE AJUSTE DO EIXO DE EQUILÍBRIO JAGUAR/LAND ROVER 2.0D

MARCAS	JAGUAR: E-PACE D150, D180, D240 (X540) (2017-), F-PACE 20D, 25D, E-PERFORMANCE (X761) (2016-), XE 20D, 25D, E-PERFORMANCE (X760) (2015-), XF 20D, 25D, E-PERFORMANCE (X260) (2015-) LAND ROVER: DEFENDER SD4 D200, SD4 D240 (L663) (2019-2021), DISCOVERY SPORT ED4, SD4, TD4, D150, D180, D240 MHEV (L550) (2015-), DISCOVERY SD4, TD4 (L462) (2017-2021) RANGE ROVER: EVOQUE ED4, SD4, TD4 (L538) (2015-2019), EVOQUE D150, D180, D240 MHEV (L551) (2019-), SPORT SD4 (L494) (2016-2018), VELAR D180, D240 (L560) (2017-)
FERRAMENTAS OEM	JLR-303-1662, JLR303-1663-1, JLR303-1663-2, JLR303-1663-3, JLR-303-1664, JLR-303-1665
CÓDIGOS DE MOTOR	AJ200, AJ200D, 204DT, 204DTA, 204DTD



54423

108,00€



KIT DE BLOQUEIO LAND ROVER 3.6D

MARCAS	RANGE ROVER SPORT: 3.6 (TDV8) DIESEL (2006-2011) RANGE ROVER: 3.6 (TDV8) DIESEL (2006-2011)
FERRAMENTAS OEM	303-1234, 303-1236, 303-1238, 303-1239, 303-1243, 303-1620
CÓDIGOS DE MOTOR	368DT



54425

124,00€

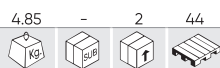

KIT DE BLOQUEIO LAND ROVER FREELANDER V6/ROVER KV6 2.0L, 2.5L



MARCAS	LAND ROVER: FREELANDER (2000-2006) MG: ZR (2004-2005), ZS (2001-2005), ZT (2001-2005) ROVER: 45 (1999-2005), 75 (1999-2005), 825 (1996-1999)
FERRAMENTAS OEM	LRT 12 175, LRT 12 187, LRT 12 195, LRT 12 196, LRT 12 198, LRT 12 232, T40011, 12 175, 12 187, 12 196, 12 198, 12 232, 18G 1746A, 18G 1747, 18G 1747 2, 18G 1747 5, 18G 17471, 303 973, 303 986, 303 989
CÓDIGOS DE MOTOR	KV6

54426

69,00€

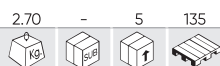

KIT DE BLOQUEIO JAGUAR/LAND ROVER 3.2, 3.5, 4.0, 4.2, 4.4



MARCAS	DAIMLER: V8 (97-03), SUPER V8 (97-03), SUPER EIGHT (05-10) JAGUAR: S-TYPE (99-08), XF (08-09), XJR (97-10), XJ8 (97-10), XKR (98-09), XK8 (96-09) LAND ROVER: DISCOVERY III (04-09) RANGE ROVER (05-09), RANGE ROVER SPORT (05-09)
FERRAMENTAS OEM	T40011, 303530, 303531, 303532, 303533, 303645, 303654
CÓDIGOS DE MOTOR	AC, BC, CC, CE, DC, EC, GB, GC, HB, HG, KB, KC, LB, LC, MA, MB, NB, NC, PB, PC, RB, SB, TB, 1B, 1G, 2B, 3B, 428PS, 448PN, 5G, 9G

54427

113,00€



FERRAMENTA DE BLOQUEIO DA POLIA DA CAMBOTA JAGUAR/LAND ROVER 4.0, 4.2, 4.4



MARCAS	DAIMLER: V8; 4.0 (97-98) JAGUAR: S-TYPE; 3.2, 3.5, 4.2 V8 (99-08), XF; 3.2, 3.5, 4.2 V8 (08-09), XJ; 3.2, 3.5, 4.2 V8 (97-08), XJ8; 4.0 (97-98), XK; 3.2, 3.5, 4.2 V8 (97-08), XK8; 4.0 (97-98) LAND ROVER: DISCOVERY3; 4.2, 4.4 LA V8 (05-09), RANGE ROVER; 4.2, 4.4 SPORT LS V8 (05-09), RANGE ROVER; 4.2, 4.4 LM V8 (06-08)
FERRAMENTAS OEM	LRT 12 080, 18G 1437, 18G 1437 2, 303 191, 303 191 03, 303 191 04, 303 588, 303 893
CÓDIGOS DE MOTOR	AJ26, AJ27, AJ28, AJ34, 30G, 36D, 42D, 428PS, 448PN, 56D, 58D, 94D

54428

31,00€

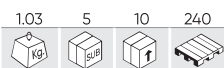

KIT DE BLOQUEIO CHRYSLER/JEEP 2.8 CRD

MARCAS	CHRYSLER: GRAND VOYAGER 2.8 (2008-) DODGE: NITRO 2.8 (2007-) JEEP: CHEROKEE 2.8 (2008-), WRANGLER 2.8 (2007-)
FERRAMENTAS OEM	VM 9991, VM 9992
CÓDIGOS DE MOTOR	ENS (VM10D), ENS (VM11D), ENS (VM51C), ENS (VM52C), ENS (VM64C), VM10D, VM11D, VM51C, VM52C, VM64C



54429

55,00€

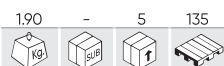

KIT DE BLOQUEIO CHRYSLER/JEEP 3.0D

MARCAS	CHRYSLER: 300 C (2012 - 2015) JEEP: GRAND CHEROKEE (2011 -)
FERRAMENTAS OEM	VM 10359, VM10338 1, VM10338 2, VM10339, VM10359, VM10359A
CÓDIGOS DE MOTOR	EXF, EXF VM23D, EXF VM44D, EXF VM63D, VM23D, VM44D, VM63D



54207

38,90€

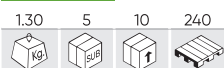

KIT DE BLOQUEIO DE DISTRIBUIÇÃO PARA CHRYSLER/JEEP 2.5 LDV CRD

MARCAS	CHRYSLER: VOYAGER (01-08), GRAND VOYAGER (01-08) JEEP: CHEROKEE (01-08) LDV: MAXUS (05-09)
FERRAMENTAS OEM	VM1052, VM1053, VM1068, VM1080, VM1089, VM8873, VM9660
CÓDIGOS DE MOTOR	R2516C, R2516K, R2516L, R2516L VM39/40B, R2816C5.05A, R2816K4



53270

70,00€

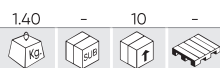

KIT DE BLOQUEIO MERCEDES/CHRYSLER/JEEP

MARCAS	CHRYSLER JEEP MERCEDES
FERRAMENTAS OEM	111589031500, 601589024000, 602589004000, 8929, 8932, 8933
CÓDIGOS DE MOTOR	M104.941, M104.943, M104.944, M104.945, M111.920, M111.921, M111.941, M111.942, M111.943, M111.944, M111.945, M111.946, M111.947, M111.948, M111.950, M111.951, M111.952, M111.955, M111.956, M111.957, M111.958, M111.961, M111.970, M111.973, M111.974, M111.975, M111.977, M111.978, M111.979, M111.980, M111.981, M111.982, M111.983, M111.984, M111.9970, M111.9971, M111.9972, M111.9980, M111.9981, M111.9982, M111.9985, M120.980, M120.981, M120.982, M120.983, M271.820, M271.860, OM601.913, OM601.915, OM601.942, OM601.943, OM601.970, OM602.980, OM602.982, OM602.984, OM602.985, OM603.971, OM604.910, OM604.912, OM604.917, OM605.910, OM605.912, OM605.960, OM605.962, OM606.912, OM606.961, OM606.962, OM611.960, OM611.961, OM611.962, OM611.980, OM611.981, OM611.987, OM612.961, OM612.962, OM612.963, OM612.967, OM612.981, OM613.960, OM613.961, OM628.960, OM628.961, OM628.962, OM628.963, OM629.910, OM629.911, OM629.912, OM642.990, OM646.811, OM646.812, OM646.820, OM646.821, OM646.951, OM646.961, OM646.962, OM646.963, OM646.966, OM646.980, OM646.981, OM646.982, OM646.983, OM646.984, OM646.986, OM646.989, OM646.990, OM647.961, OM648.960, OM648.961



53271

227,00€

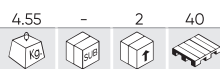

KIT DE BLOQUEIO MERCEDES BENZ M271

MARCAS	MERCEDES
FERRAMENTAS OEM	271589001500, 71589003100, 271589006100, 271589014000
CÓDIGOS DE MOTOR	271.820, 271.860, 271.861, 271.910, 271.911, 271.921, 271.940, 271.941, 271.942, 271.943, 271.944, 271.946, 271.948, 271.950, 271.951, 271.952, 271.954, 271.955, 271.956, 271.957, 271.958



53272

195,00€

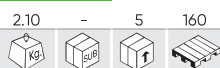

SET DE DISTRIBUIÇÃO PE MERCEDES AMG 156

MARCAS	MERCEDES: SERIES AMG
FERRAMENTAS OEM	156589003200, 156589006100, 156589006900, 156589016300
CÓDIGOS DE MOTOR	M156, M159



54738

167,00€



KIT DE FERRAMENTAS DE TEMPORIZAÇÃO DE ÁRVORES DE CAMES DE MOTORES DIESEL

MARCAS	A CLASS (2019) B CLASS (2019) C CLASS (2018) CLA (2019) CLS (2018) E CLASS (2016) GLB (2019) GLC COUPE (2019) GLE (2019) V CLASS (2019) VITO (2019)
FERRAMENTAS OEM	W654589, W654589004000, W654589014000
CÓDIGOS DE MOTOR	1.6L 654.916, 2.0L 654.920



53273

75,00€

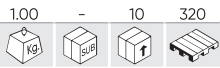

KIT DE BLOQUEIO MERCEDES M276, M157, M278

MARCAS	MERCEDES
FERRAMENTAS OEM	276589014000
CÓDIGOS DE MOTOR	152980, 157980, 157981, 157982, 157983, 157984, 157985, 276820, 276821, 276822, 276823, 276824, 276825, 276850, 276853, 276950, 276952, 276954, 276955, 276956, 276957, 276958, 276960, 278920, 278922, 278927, 278928, 278929, 278932



54414

97,50€

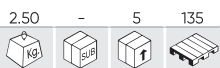

KIT DE BLOQUEIO MERCEDES M651

MARCAS	MERCEDES-BENZ: A CLASS (2012-2018), B CLASS (2012-2019), C CLASS (2009-2015), C CLASS (2014-2018), CLA COUPE (2013-2019), CLS (2011-2018), E CLASS (2009-2016), GLA (2014-2020), GLC (2015-2019), GLE (2015-2019), GLK (2008-2015), M CLASS (2011-2015), S CLASS (2010-2013), S CLASS (2013-2017), SLK (2016-2017), SLK (2012-2016), SPRINTER (2009-2018), SPRINTER (2018-), V CLASS (2014-), VIANO (2010-2015), VITO (2010-2015), VITO (2014-)
FERRAMENTAS OEM	608 31 800, 608 31 810, 608 31 820, 608 31 830, 651589004000, 651589014000, 651589034000, 651589094000
CÓDIGOS DE MOTOR	651900, 651901, 651910, 651911, 651912, 651913, 651916, 651921, 651922, 651924, 651925, 651930, 651940, 651950, 651956, 651957, 651958, 651960, 651961, 651980



54415

60,00€

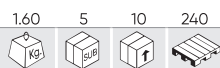

KIT DE BLOQUEIO MERCEDES M651

MARCAS	MERCEDES-BENZ: A-CLASS 2012-2014, B-CLASS 2012-2014, C-CLASS 2009-2014, C-CLASS COUPE 2011-2014, CLA 2013-2014, CLS 2011-2014, E-CLASS 2009-2014, E-CLASS COUPE/CABRIOLET 2009-2014, GLK 2008-2014, M-CLASS 2011-2014, S-CLASS 2010-2013, SLK 2012-2014, SPRINTER 2009-2014, V DODGE: CALIBER 2009-2011 JEEP: COMPASS 2010-2014
FERRAMENTAS OEM	651589004000, 651589014000
CÓDIGOS DE MOTOR	1201634200, 120634200, 1211634200, 651901, 651910, 651911, 651912, 651913, 651916, 651922, 651924, 651925, 651940, 651955, 651956, 651957, 651960, 651961, 651980



54416

31,00€

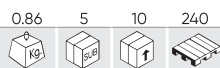

KIT DE BLOQUEIO MERCEDES M642

MARCAS	MERCEDES-BENZ: C-CLASS 203/204 2004-2014, CLK209 2005-2009, CLS219/218 2005-2018, E-CLASS211/212/213 2005-2018, E-CLASS COUPE/CABRIOLET207 2009-2017, G-CLASS461/463 2007-2015, GL-CLASS164/166 2006-2016, GLE/GLC COUPE166/292 2015-2020, GLK204 2008-2015, GLS166 2016-2019,
FERRAMENTAS OEM	642589003100
CÓDIGOS DE MOTOR	642820, 642822, 642826, 642830, 642832, 642834, 642835, 642836, 642838, 642850, 642852, 642853, 642854, 642855, 642856, 642858, 642861, 642862, 642867, 642868, 642870, 642872, 642884, 642886, 642890, 642896, 642910, 642920, 642921, 642922, 642930, 642932, 642940, 642950, 642960, 642961, 642970, 642975, 642990, 642992, 642993



54418

37,00€



KIT DE BLOQUEIO MERCEDES M112, M113

MARCAS	MERCEDES: C-CLASS 240/280 (202) 1998-ON, C-CLASS 240/320 (203) 2000-ON, CL 500 (215) 1999-2007, CLK 320/430 (208) 1997-2003, CLK 240/320/500/55 AMG (209) 1997-ON, CLS 500/55 AMG (219) 2005-ON, E-CLASS 240/280/320/430 (210) 1997-ON, E-CLASS 240/320/500/E55 AMG (211)
FERRAMENTAS OEM	112589000100, 112589003200, 112589013200
CÓDIGOS DE MOTOR	M112, M113, 112910, 112911, 112912, 112913, 112914, 112915, 112916, 112917, 112920, 112921, 112922, 112923, 112940, 112941, 112942, 112943, 112944, 112947, 112949, 112951, 112953, 112954, 112955, 112970, 112972, 112973, 112975, 112976, 113940, 113941, 113942, 113943, 113948, 113960, 113961, 113963, 113964, 113965, 113966, 113967, 113968, 113969, 113971, 113981, 113987, 113989, 113990, 113992, 113995



54417 **153,00€**

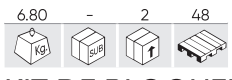

KIT DE BLOQUEIO MERCEDES M133, M270, M274

MARCAS	MERCEDES: A-CLASS 176 1.6/2.0 2012-ON, B-CLASS 242/246 1.6/2.0 2012-ON, C-CLASS COUPÉ 1.6/2.0 2011-ON, C-CLASS 204 1.6/2.0 2011-ON, CLA 117 1.6/2.0 2012-ON, E-CLASS 212 1.6/2.0 2011-ON
FERRAMENTAS OEM	270589006100
CÓDIGOS DE MOTOR	M133, M270, M274

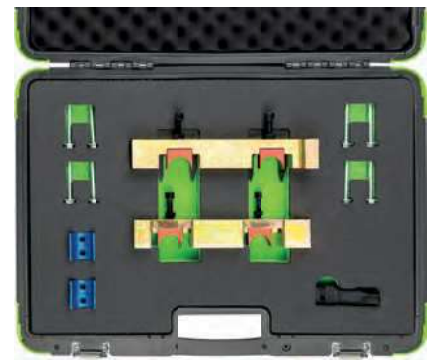

51488 **16,00€**

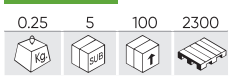

BLOQUEADOR DE CAMBOTA E ÁRVORE DECAMES RENAULT/NISSAN/DACIA/SUZUKI

MARCAS	RENAULT: CAPTUR 2013-2019, CLIOII, III, IV 1999-2019, ESPACE/GRANDESPEACEIII,IV 1999-2007, FLUENCE 2009-2015, KADJAR 2015-2018, KANGOO 1999-ON, LAGUNAI,II,III 1999-2015, LOGAN/LOGANMCV 2006-2011, MEGANEI,II,III 1997-2018, MODUS/GRANDMODUS 2004-2013, SCENIC/GRANDS DACIA: DOKKER 2012-1018, DUSTER 2010-2018, LODGY 2012-2018, LOGAN 2005-2018, SANDERO 2008-2018 NISSAN: ALMERA 2002-2006, CUBE 2009-2011, JUKE 2010-ON, KUBISTAR 2003-2009, MICRA 2003-2019, NOTE 2006-2013, NV200/EVALIA 2009-2019, PRIMERA 2003-2007,QASHQAI (J10) 2007-ON, TIIDA 2007-2011, INTERSTAR 2002-2006,PRIMASTAR 2002-2007 SUZUKI: GRAND VITARA 2005-2015, JIMNY 2003-2011
--------	--



FERRAMENTAS OEM	EN-52137, KM6031, MOT 1054, MOT 1489, MOT 861, MOT 863, MOT1430, 0132AJ1, 0187B, 0189B, 0194B, 991246510, 09919 58110, 09919 58120, 21263, 3031277, 303735, 49JE02021, 6075890015, 9997122
CÓDIGOS DE MOTOR	F9Q B2, F9Q 650, F9Q 660, F9Q 664, F9Q 670, F9Q 674, F9Q 680, F9Q 690, F9Q 710, F9Q 716, F9Q 717, F9Q 718, F9Q 720, F9Q 722, F9Q 730, F9Q 731, F9Q 732, F9Q 733, F9Q 734, F9Q 736, F9Q 740, F9Q 744, F9Q 748, F9Q 750, F9Q 751, F9Q 752, F9Q 754, F9Q 755, F9Q 758, F9Q 759, F9Q 760, F9Q 762, F9Q 770, F9Q 772, F9Q 774, F9Q 780, F9Q 782, F9Q 790, F9Q 800, F9Q 803, F9Q 804, F9Q 808, F9Q 812, F9Q 814, F9Q 816, F9Q 818, F9Q 820, F9Q 826, F9Q 870, F9Q 872, K9K 262, K9K 266, K9K 276, K9K 299, K9K 400, K9K 500, K9K 608, K9K 609, K9K 612, K9K 626, K9K 628, K9K 629, K9K 636, K9K 638, K9K 639, K9K 646, K9K 647, K9K 656, K9K 657, K9K 658, K9K 666, K9K 667, K9K 676, K9K 677, K9K 700, K9K 702, K9K 704, K9K 706, K9K 710, K9K 712, K9K 714, K9K 716, K9K 718, K9K 722, K9K 724, K9K 728, K9K 729, K9K 732, K9K 734, K9K 740, K9K 750, K9K 752, K9K 760, K9K 762, K9K 764, K9K 766, K9K 768, K9K 770, K9K 772, K9K 774, K9K 780, K9K 782, K9K 790, K9K 792, K9K 794, K9K 796, K9K 800, K9K 802, K9K 804, K9K 806, K9K 808, K9K 812, K9K 816, K9K 820, K9K 826, K9K 830, K9K 832, K9K 834, K9K 836, K9K 837, K9K 838, K9K 842, K9K 846, K9K 856, K9K 858, K9K 872, K9K 884, K9K 892, K9K 894, K9K 896, K9K 898

54593 **120,50€**

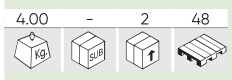

KIT DE CORREIA DE DISTRIBUIÇÃO RENAULT 1.4, 1.6, 1.8, 2.0 16V TWIN

MARCAS	1999 RENAULT MÉGANE, SCÉNIC,CLIO III, KANGOO, KANGOO II, LAGUNA 1999-2003 RENAULT SCENIC, RENAULT KANGOO II, DACIA LOGAN 1999-2008 RENAULT CLIO II, MEGANE, SCENIC, SCÉNIC 2001-2005 RENAULT LAGUNA 2002-2008 RENAULT MÉGANE 2003-2009 RENAULT LAGUNA 2003-2010 RENAULT MEGANE II, SCÉNIC, RENAULT CLIO II, RENAULT THALIA 2004-2010 RENAULT CLIO III, RENAULT MODUS, RENAULT GRAND MODUS 2006-2007 RENAULT LAGUNA 2010 DACIA DUSTER, DACIA LOGAN, DACIA SANDERO
FERRAMENTAS OEM	KM-6031, KM-6233, MOT 1054, MOT 1489, MOT 1490-01, MOT 1496, MOT 1509-01, MOT 1750, MOT 1801, MOT 861
CÓDIGOS DE MOTOR	F4P, F4R, K4J, K4M, K9K



53290

51,00€

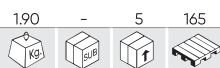

KIT DE BLOQUEIO RENAULT/VOLVO 16V, 20V

MARCAS	RENAULT: LAGUNA 2.0 16V / 2.5 20V (1996-1999), SAFRANE 2.0 16V / 2.5 20V (1996-2001) VOLVO: 850 (1992-1997), C70 (1998-2002), S40 (1996-2004), V40 (1996-2004), S60 (2001-2005), S70 (1997-2000), S80 (1999-2005)
FERRAMENTAS OEM	MOT 1337, MOT 1340, MOT 1348, 303-1178, 303-1182, 999 5451, 999 5452
CÓDIGOS DE MOTOR	B4164S, B4164S2, B4184S, B4184S2, B4184S3, B4184S9, B4194T2, B4204S, B4204S2, B4204T, B4204T2, B4204T3, B4204T5, B5204T, B5204T2, B5204T3, B5204T4, B5204T5, B5234T, B5234T3, B5234T4, B5234T7, B5234T9, B5244S, B5244SG, B5244SG3, B5244S2, B5244T, B5244T3, B5244T7, B5254S, B5254T, B5254T2, B5254T4, N7Q700, N7Q704, N7Q710, N7Q711



53289

45,00€

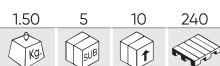

KIT DE BLOQUEIO RENAULT 1.4, 1.6, 1.8, 2.0 16V

MARCAS	DACIA: LOGAN / MCV (05-11) RENAULT: ESPACE / GRAND ESPACE (98-02), ESPACE / GRAND ESPACE IV (02-10) KANGOO/TREKKA (01-09), LAGUNA (98-01), LAGUNA II (01-07), LAGUNA III (07-13), MEGANE (99-03), MEGANE II (02-10) MEGANE III/SPORT (08-13), MEGANE / SCENIC (99-00), SCENIC / RX4 (99-03) NISSAN: KUBISTAR X76 (03-09), PRIMASTAR (02-11) OPEL: JETTA, TOURAN, GOLF, GOLF PLUS, POLO, PASSAT, TIGUAN, SCIROCCO SCENIC / GRAND SCENIC III (03-09), TRAFIC II (01-11) TWINGO II (08-14), VEL SATIS (00-10), WIND (10-14)
FERRAMENTAS OEM	KM6031, MOT 1054, MOT 1489, MOT 1496, MOT 1496/1750, MOT 861, MOT 863, 09912 46510, 0991958110, 6031, 607589001500
CÓDIGOS DE MOTOR	F4P720, F4P722, F4P760, F4P770, F4P771, F4P772, F4P773, F4P774, F4P775, F4P776, F4P777, F4P778, F4P779, F4P780, F4P781, F4P782, F4P783, F4P784, F4P785, F4P786, F4P787, F4P788, F4P789, F4P790, F4P791, F4P792, F4P793, F4P794, F4P795, F4P796, F4P797, F4P798, F4P799, F4R700, F4R701, F4R702, F4R703, F4R704, F4R705, F4R706, F4R707, F4R708, F4R709, F4R710, F4R711, F4R712, F4R713, F4R714, F4R715, F4R716, F4R717, F4R718, F4R719, F4R720, F4R721, F4R722, F4R723, F4R724, F4R725, F4R726, F4R727, F4R728, F4R729, F4R730, F4R731, F4R732, F4R733, F4R734, F4R735, F4R736, F4R737, F4R738, F4R739, F4R740, F4R741, F4R742, F4R743, F4R744, F4R745, F4R746, F4R747, F4R748, F4R749, F4R750, F4R751, F4R752, F4R753, F4R754, F4R755, F4R756, F4R757, F4R758, F4R759, F4R760, F4R761, F4R762, F4R763, F4R764, F4R765, F4R766, F4R767, F4R768, F4R769, F4R770, F4R771, F4R772, F4R773, F4R774, F4R775, F4R776, F4R777, F4R778, F4R779, F4R780, F4R781, F4R782, F4R783, F4R784, F4R785, F4R786, F4R787, F4R788, F4R789, F4R790, F4R791, F4R792, F4R793, F4R794, F4R795, F4R796, F4R797, F4R798, F4R799, F4R800, F4R801, F4R802, F4R803, F4R804, F4R805, F4R806, F4R807, F4R808, F4R809, F4R810, F4R811, F4R812, F4R813, F4R814, F4R815, F4R816, F4R817, F4R818, F4R819, F4R820, F4R821, F4R822, F4R823, F4R824, F4R825, F4R826, F4R827, F4R828, F4R829, F4R830, F4R831, F4R832, F4R833, F4R834, F4R835, F4R836, F4R837, F4R838, F4R839, F4R840, F4R841, F4R842, F4R843, F4R844, F4R845, F4R846, F4R847, F4R848, F4R849, F4R850, F4R851, F4R852, F4R853, F4R854, F4R855, F4R856, F4R857, F4R858, F4R859, F4R860, F4R861, F4R862, F4R863, F4R864, F4R865, F4R866, F4R867, F4R868, F4R869, F4R870, F4R871, F4R872, F4R873, F4R874, F4R875, F4R876, F4R877, F4R878, F4R879, F4R880, F4R881, F4R882, F4R883, F4R884, F4R885, F4R886, F4R887, F4R888, F4R889, F4R890, F4R891, F4R892, F4R893, F4R894, F4R895, F4R896, F4R897, F4R898, F4R899, F4R900, F4R901, F4R902, F4R903, F4R904, F4R905, F4R906, F4R907, F4R908, F4R909, F4R910, F4R911, F4R912, F4R913, F4R914, F4R915, F4R916, F4R917, F4R918, F4R919, F4R920, F4R921, F4R922, F4R923, F4R924, F4R925, F4R926, F4R927, F4R928, F4R929, F4R930, F4R931, F4R932, F4R933, F4R934, F4R935, F4R936, F4R937, F4R938, F4R939, F4R940, F4R941, F4R942, F4R943, F4R944, F4R945, F4R946, F4R947, F4R948, F4R949, F4R950, F4R951, F4R952, F4R953, F4R954, F4R955, F4R956, F4R957, F4R958, F4R959, F4R960, F4R961, F4R962, F4R963, F4R964, F4R965, F4R966, F4R967, F4R968, F4R969, F4R970, F4R971, F4R972, F4R973, F4R974, F4R975, F4R976, F4R977, F4R978, F4R979, F4R980, F4R981, F4R982, F4R983, F4R984, F4R985, F4R986, F4R987, F4R988, F4R989, F4R990, F4R991, F4R992, F4R993, F4R994, F4R995, F4R996, F4R997, F4R998, F4R999, F4R1000



53292

116,00€



KIT DE BLOQUEIO RENAULT/OPEL 2.2, 2.5 TDI DCI

MARCAS	OPEL: VIVARO, MOVANO DIESEL, ASTRAB, VECTRA B, SIGNUM, ZAFIRA RENAULT: LAGUNA II, ESPACE, MASTER, TRAFIC, 2.2 / 2.5 DCI
FERRAMENTAS OEM	KM 6077, KM 6148, KM 6203, KM 6204, KM 6205, MOT 1534, MOT 1536, MOT 1537, MOT 1538, 6204, 6205
CÓDIGOS DE MOTOR	G9T600, G9T605, G9T606, G9T607, G9T642, G9T645, G9T700, G9T702, G9T703, G9T706, G9T707, G9T710, G9T720, G9T722, G9T743, G9T744, G9T750, G9U630, G9U632, G9U650, G9U720, G9U724, G9U726, G9U730, G9U750, G9U754, Z225E, Z225YH



53291

68,00€

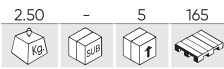

KIT DE BLOQUEIO RENAULT

MARCAS	RENAULT: CLIO, LAGUNA, MEGANE
FERRAMENTAS OEM	KM6031, MOT 1054, MOT 1489, MOT 1490-01, MOT 1496, MOT 1750, MOT 861, MOT 863, MOTT1750, 0991246510, 0991958110
CÓDIGOS DE MOTOR	F4P720, F4P722, F4P760, F4P770, F4P771, F4P772, F4P773, F4P774, F4P775, F4Rt870, F4Rt872, F4Rt886, F4Rt887, F4Rt896, F4Rt897, K4J700, K4J710, K4J711, K4J712, K4J713, K4J714, K4J715, K4J730, K4J732, K4J740, K4J750, K4J770, K4M 606, K4M 782, K4M616, K4M690, K4M696, K4M697, K4M700, K4M701, K4M704, K4M706, K4M708, K4M709, K4M718, K4M720, K4M724, K4M730, K4M732, K4M734, K4M736, K4M740, K4M742, K4M743, K4M744, K4M760, K4M761, K4M764, K4M766, K4M776, K4M790, K4M791, K4M792, K4M794, K4M800, K4M824, K4M830, K4M831, K4M834, K4M846, K4M848, K4M854, K4M858, K4M862, K4M866



53311

97,00€

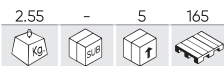

KIT DE BLOQUEIO RENAULT/NISSAN/OPEL/VAUXHALL 1.6, 2.0, 2.3 DCI

MARCAS	MERCEDES-BENZ: C-CLASS 2014-2018 NISSAN: NV400 2011-2019, PRIMASTAR 2006-2015, QASHQAI/QASHQAI+2 2007-2014, QASHQAI 2014-ON, X-TRAIL II 2007-2014, X-TRAIL III 2014-ON RENAULT: ESPACE/GRAND ESPACE IV 2006-2015, ESPACE V 2015-2018, FLUENCE 2013-2015, KADJAR 2015-2018, KOLEOS 2008-2016, KOLEOS II 2017-2019, LAGUNA II 2005-2007, LAGUNA III 2007-2015, LATITUDE 2010-2016, MASTER III 2010-2019, MEGANE II 2006-2010, MEGANE III VAUXHALL/OPEL: MOVANO-B 2010-2019, VIVARO-A 2006-2014, VIVARO-B 2014-2019
FERRAMENTAS OEM	EN 48330, EN 48331, EN 48334, EN-48332, EN-51241, EN-955-2, KM6130, MOT 1766, MOT 1769, MOT 1770, MOT 1773MOT, MOT 1969, MOT 1970, 09953 05010, 48332, 626589001500, 626589024000, 626589044000
CÓDIGOS DE MOTOR	M9R, M9R 610, M9R 613, M9R 615, M9R 630, M9R 692, M9R 700, M9R 721, M9R 722, M9R 724, M9R 740, M9R 742, M9R 744, M9R 746, M9R 748, M9R 750, M9R 754, M9R 756, M9R 760, M9R 761, M9R 762, M9R 763, M9R 780, M9R 782, M9R 784, M9R 786, M9R 788, M9R 800, M9R 802, M9R 803, M9R 804, M9R 805, M9R 806, M9R 808, M9R 809, M9R 811, M9R 812, M9R 814, M9R 815, M9R 816, M9R 817, M9R 820, M9R 824, M9R 828, M9R 830, M9R 832, M9R 833, M9R 834, M9R 835, M9R 836, M9R 838, M9R 839, M9R 844, M9R 845, M9R 846, M9R 849, M9R 854, M9R 855, M9R 856, M9R 857, M9R 858, M9R 859, M9R 864, M9R 865, M9R 866, M9T 670, M9T 672, M9T 676, M9T 678, M9T 680, M9T 686, M9T 690, M9T 692, M9T 694, M9T 696, M9T 698, M9T 700, M9T 702, M9T 704, M9T 706, M9T 708, M9T 710, M9T 870, M9T 880, M9T 890, M9T 892, M9T 896, M9T 898, R9M, R9M 402, R9M 404, R9M 408, R9M 409, R9M 410, R9M 413, R9M 414, R9M 415, R9M 450, R9M 452, R9M 453, 622951, 626951



54210

84,00€

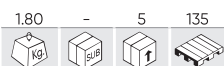

KIT DE BLOQUEIO DA ÁRVORE DE CAMES PARA RENAULT 1,8, 2,0 16 V

MARCAS	RENAULT: LAGUNA II (2001-2009) MEGANE II (2002-2009), SCENIC (2002-2009)
FERRAMENTAS OEM	MOT 1509, MOT 1509-01
CÓDIGOS DE MOTOR	F4P, F4R, F4RT776, F4RT784, F4RT786, F4RT787, F4R770, F4R771



53523

91,00€

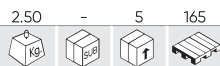

KIT DE BLOQUEIO DE MOTORES A DIESEL RENAULT/NISSAN/OPEL 1.6, 2.0, 2.3 DCI

MARCAS	<p>MERCEDES-BENZ: C-CLASS 2014-2018</p> <p>NISSAN: NV400 2011-2019, PRIMASTAR 2006-2015, QASHQAI/QASHQAI+2 2007-2014, QASHQAI 2014-ON, X-TRAIL II 2007-2014, X-TRAIL III 2014-ON</p> <p>RENAULT: ESPACE/GRAND ESPACE IV 2006-2015, ESPACE V 2015-2018, FLUENCE 2013-2015, KADJAR 2015-2018, KOLEOS 2008-2016, KOLEOS II 2017-2019, LAGUNA II 2005-2007, LAGUNA III 2007-2015, LATITUDE 2010-2016, MASTER III 2010-2019, MEGANE II 2006-2010, MEGANE III</p> <p>VAUXHALL/OPEL: MOVANO-B 2010-2019, VIVARO-A 2006-2014, VIVARO-B 2014-2019</p>
FERRAMENTAS OEM	EN 48330, EN 48331, EN 48334, EN-48332, EN-51241, EN-955-2, KM6130, MOT 1766, MOT 1769, MOT 1770, MOT 1773MOT., MOT 1969, MOT 1970, 09953 05010, 48332, 626589001500, 626589024000, 626589044000
CÓDIGOS DE MOTOR	M9R, M9R 610, M9R 613, M9R 615, M9R 630, M9R 692, M9R 700, M9R 721, M9R 722, M9R 724, M9R 740, M9R 742, M9R 744, M9R 746, M9R 748, M9R 750, M9R 754, M9R 756, M9R 760, M9R 761, M9R 762, M9R 763, M9R 780, M9R 782, M9R 784, M9R 786, M9R 788, M9R 800, M9R 802, M9R 803, M9R 804, M9R 805, M9R 806, M9R 808, M9R 809, M9R 811, M9R 812, M9R 814, M9R 815, M9R 816, M9R 817, M9R 820, M9R 824, M9R 828, M9R 830, M9R 832, M9R 833, M9R 834, M9R 835, M9R 836, M9R 838, M9R 839, M9R 844, M9R 845, M9R 846, M9R 849, M9R 854, M9R 855, M9R 856, M9R 857, M9R 858, M9R 859, M9R 864, M9R 865, M9R 866, M9T 670, M9T 672, M9T 676, M9T 678, M9T 680, M9T 686, M9T 690, M9T 692, M9T 694, M9T 696, M9T 698, M9T 700, M9T 702, M9T 704, M9T 706, M9T 708, M9T 710, M9T 870, M9T 880, M9T 890, M9T 892, M9T 896, M9T 898, R9M, R9M 402, R9M 404, R9M 408, R9M 409, R9M 410, R9M 413, R9M 414, R9M 415, R9M 450, R9M 452, R9M 453, 622951, 626951



54225

133,00€



KIT DE BLOQUEIO DE VOLANTE / POLIA DA CAMBOTA PARA RENAULT/NISSAN

MARCAS	<p>NISSAN: PRIMASTAR (06-15), QASHQAI/QASHQAI+2(07-14), X-TRAIL (07-14), NAVARA (15-16) NV400 (11-16)</p> <p>RENAULT: ESPACE V (15-16), CLIO (06-16), FLUENCE (09-15), LAGUNA (05-15), LATITUDE (10-15), MEGANE (06-15), SCENIC/GRAND SCENIC (06-15), SPACE/GRAND ESPACE IV (02-15), KOLEOS (08-16), TRAFIC II (07-15), VEL SATIS (00-10), MASTER III (10-16)</p>
FERRAMENTAS OEM	MOT 1431, MOT 1716, MOT 1789, MOT 2019, MOT 919-02
CÓDIGOS DE MOTOR	H4JT 700, M4R 700, M4R 701, M4R 704, M4R 711, M4R 713, M4R 714, M4R 737, M4R 746, M4R 750, M4R 751, M4R 752, M4R 753, M4R 754, M5M 400, M5M 450, M9R 610, M9R 613, M9R 630, M9R 700, M9R 721, M9R 722, M9R 724, M9R 726, M9R 730, M9R 735, M9R 740, M9R 742, M9R 744, M9R 746, M9R 748, M9R 750, M9R 756, M9R 760, M9R 761, M9R 762, M9R 763, M9R 780, M9R 782, M9R 784, M9R 786, M9R 788, M9R 800, M9R 802, M9R 803, M9R 804, M9R 805, M9R 806, M9R 808, M9R 809, M9R 811, M9R 812, M9R 814, M9R 815, M9R 816, M9R 817, M9R 820, M9R 824, M9R 828, M9R 830, M9R 832, M9R 833, M9R 834, M9R 835, M9R 836, M9R 838, M9R 839, M9R 844, M9R 845, M9R 846, M9R 849, M9R 854, M9R 855, M9R 856, M9R 857, M9R 858, M9R 859, M9R 865, M9R 866, M9T C6, M9T 670, M9T 672, M9T 676, M9T 678, M9T 680, M9T 686, M9T 690, M9T 692, M9T 694, M9T 696, M9T 698, M9T 700, M9T 702, M9T 706, M9T 708, M9T 870, M9T 880, M9T 890, M9T 896, M9T 898, M9S 615, VQ25, V4U 604, V4Y 701, V4Y 711, V4Y 713, V4Y 715, YS23DDT, YS23DDTT, 2TR 700, 2TR 702, 2TR 703, 2TR 704, 2TR 705, 2ZV 604



54289

38,00€

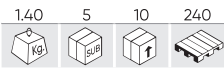

KIT DE BLOQUEIO DO VOLANTE DE INÉRCIA PARA MERCEDES/RENAULT/DACIA/NISSAN

MARCAS	<p>DACIA: DOKER 2015 +, DUSTER 2015+, LODGY 2015+, LOGAN 2013/-2020, SANDERO 2013+</p> <p>MERCEDES-BENZ: A-CLASS 2018+, B-CLASS 2019+, CLA 2019+, GLA 2019+, GLB 2019+</p> <p>RENAULT: ARKANA 2019+, CAPTUR 2018+, CLIO V 2019 +, KADJAR 2018+, MEGANE IV 2017+, SCENIC/GRAND SCENIC IV 2018+, TALISMAN 2018+</p>
FERRAMENTAS OEM	MOT.2188
CÓDIGOS DE MOTOR	HR13DDT, H4Bt 400, H4Bt 408, H4Bt 410, H4Bt 411, H4M 730, H4M 738, H4M 740, H5H 450, H5H 470, H5H 480, 282.914



54477

58,50€

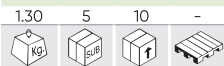

FERRAMENTA DE CRONOMETRAGEM DIESEL OPEL/CHEVROLET SUZUKI 1.9 E 2.5 DTI - CDTI

MARCAS	<p>CHRYSLER: CHEROKEE (1984-1995), WRANGLER (1988-1995)</p> <p>DACIA: LOGAN MCV (2013-), DACIA LOGAN (2004-2013), DACIA LOGAN (2013-), SANDERO (2008-2013), SANDERO (2013-)</p> <p>MITSUBISHI: CARISMA (2001-2005), SPACE STAR (2000-2006)</p> <p>OPEL: ARENA (1997-2001), MOVANO A (1998-2010), VIVARO (2001-2007)</p> <p>RENAULT: CLIO II (1998-2013), CLIO III (2005-2015), CLIO IV (2012-2020), ESPACE (2002-2015), GRAND ESPACE IV (2002-2015), GRAND MODUS II (2004-2013), KANGOO (1998-2009), MASTER II (1998-2010), MEGANE (1999-2003), MODUS (2004-2013), SAFRANE (1992-2001), SCENIC (1999-2003), SYMBOL (2001-2008), THALIA (2001-2008), TRAFIC (1997-2000), TWINGO II (2007-2014), TWINGO (1993-2007), WIND (2010-2013)</p>
FERRAMENTAS OEM	KM-603, KM-6031, KM-966
CÓDIGOS DE MOTOR	D4F 700, D4F 702, D4F 704, D4F 706, D4F 708, D4F 712, D4F 714, D4F 716, D4F 722, D4F 728, D4F 730, D4F 732, D4F 734, D4F 740, D4F 742, D4F 744, D4F 764, D4F 770, D4F 772, D4Ft 780, D4Ft 782, D4Ft784, D4Ft786, D7F B700, D7F C701, D7F 702, D7F 704, D7F 708, D7F 710, D7F 720, D7F 722, D7F 726, D7F 744, D7F 746, D7F 764, D7F 766, D7F 800, D7F706, E7J 626, E7J 634, E7J 635, E7J 780, F8Q 622, F8Q 630, F8Q 632, F8Q 720, F8Q 722, F8Q 731, F8Q 736, F8Q 744, F8Q 770, F8Q 780, F8Q 782, F8Q 790, F9Q 710, F9Q 730, F9Q 734, F9Q 744, F9Q 770, K7J 710



54438

40,00€

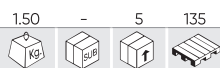

KIT DE BLOQUEIO RENAULT/NISSAN 3.0DCI

MARCAS	NISSAN: NAVARA PICK UP, PATHFINDER, INFINITI RENAULT: LAGUNA, LATITUDE
FERRAMENTAS OEM	MOT1874, MOT1880, MOT1970
CÓDIGOS DE MOTOR	V9X, V9X791, V9X891



54439

32,50€

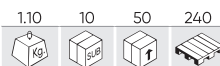

BLOQUEIO DA POLIA DA EIXO DE MANIVELAS RENAULT/DACIA 0.9, 1.0, 1.2, 1.6 TCE

MARCAS	DACIA: DOKKER 2012-2019, DUSTER 2013-2018, LODGY 2012-2018 RENAULT: CAPTUR 2013-2019, CLIO IV 2012-2019, KADJAR 2015-2018, KANGOOII 2013-ON, MEGANEIII 2012-2017, MEGANEIV 2016-2020, SCENIC/GRAND SCENICIII 2012-2017, SCENIC/GRAND SCENICIV 2016-2018, TWINGOIII 2014-ON SMART: FORTWO 2014-2019, FORFOUR 2014-2019
FERRAMENTAS OEM	MOT.2006, MOT.2054, 281589004000
CÓDIGOS DE MOTOR	H4B, H4B 408, H4B 453, H4BT 400, H4BT 401, H4BT 408, H4BT 410, H4BT 451, H4B400, H4B401, H4B408, H4B410, H4B411, H4B451, H4B453, H4D, H4D 400, H4D400, H4D450, H4D460, H4D470, H4M, H4M429, H4M438, H4M440, H4M729, H4M730, H4M738, H4M740, H4M748, H4M749, H5F, H5F 408, H5F 410, H5FT 400, H5FT 402, H5FT 404, H5FT 405, H5FT 408, H5FT 410, H5FT 412, H5F400, H5F403, H5F404, H5F405, H5F408, H5F410, H5F412, 281910, 281910(H4B), 281920, 281920(H4D)



53299

291,00€

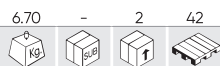

KIT DE BLOQUEIO OPEL/VAUXHALL

MARCAS	OPEL/VAUXHALL: 1.3 CDTI 16V, 1.9 CDTI, 2.0 DTI, 2.2 DTI
FERRAMENTAS OEM	EN-46785, EN-46788, EN-46789, EN-49978, KM927, KM929, KM932, KM933, 1860985000
CÓDIGOS DE MOTOR	A10XEP, A12XER, A13DTC, A13DTE, A13DTR, A13FD, A14NEL, A14XEL, BAAA, B12XEL, B14NEH, B14NEL, B14NET, C20SEL, D13A, D223L, FD4, FHYFHZ, FHZ, F13DTE5, LDV, LUJ, LUVLDD, X10XE, X12XE, X14XE, X16SEJ, X16XEL, X18E1, X18XE, X18XE1, X20DTH, X20DTL, X20XEV, X22DTH, X22XE, Y13DT, Y16XE, Y20DTH, Y20DTL, Y22DTH, Y22DTR, Y22XE, Z10XE, Z10XEP, Z12XE, Z12XEP, Z13DT, Z13DTH, Z13DTJ, Z14XE, Z14XEP, Z16XE, Z18XE, Z18XEL, Z19DT, Z19DTH, Z20LET, Z22XE, 169A1.000, 188A8.000, 188A9.000, 199A2.000, 199A3.000, 199A9.000, 199B1.000, 199B4.000, 199B8.000, 223A9.000, 225A2.000, 263A2.000, 263A6.000, 312A8.000, 312B1.000, 312B2.000, 330A1.000, 55266963, 955B2.000



53305

136,00€

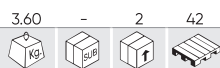

KIT DE BLOQUEIO SAAB/OPEL/VAUXHALL

MARCAS	SAAB: 900 (93-98), 9000 (95-97), 9-5 (98-03) VAUXHALL / OPEL: ANTARA (06-10), CALIBRA (93-98), CAVALIER/VECTRA-A (93-95), OMEGA-B (94-03), SIGNUM (03-05), SINTRA (96-99), VECTRA-B (95-02), VECTRA-C (02-05)
FERRAMENTAS OEM	KM-800-1, KM-800-10, KM-800-2, KM-800-20, KM-800-30, MKM-6038, 83 95 006
CÓDIGOS DE MOTOR	B2581, B308E, B308i, C25XE, X25XE, X30XE, Y26SE, Y32SE, Z32SE



53307

38,50€

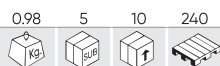

KIT DE BLOQUEIO ALFA/OPEL/VAUXHALL 1.6, 1.8 16V

MARCAS	ALFA ROMEO: 159 CHEVROLET: AVEO, CRUZE, ORLANDO FIAT: CROMA OPEL: CORSA D, AGILA, ASTRA G-H, MERIVA, ZAFIRA B, VECTRA C, SIGNUM, INSIGNIA
FERRAMENTAS OEM	EN 6130, EN 6333, EN 6340, EN 6349, EN 6625, EN 6628A, EN/KM 6333, EN/KM 6340, EN/KM 6625, KM 6130, KM 6333, KM 6340, KM 6349, KM 6625, KM 6628 A, KM 911, 2000012000, 2000012100, 2000012800, 911
CÓDIGOS DE MOTOR	A16LEL, A16LER, A16LES, A16XER, A16XNT, A18XER, G14D, LDE/A16XER, LDE/B16XER, LDE/F16D4, LGE/A16XNT, LGE/B16XNT, LLU/A16LET, LLU/B16LER, LUW, LXV/F16D4, Z16LEL, Z16LER, Z16LET, Z16XEP, Z16XER, Z16XE1, Z16XNT, Z18XER, 2HO/A18XEL, 2HO/A18XER, 2HO/Z18XER, 939A4.000



53316

34,00€

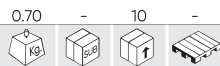

FERRAMENTA DE FIXAÇÃO DA ÁRVORE DE CAMES FIAT/OPEL/VAUXHALL 2.2 16V ACIONAMENTO POR CORRENTE

MARCAS	FIAT: CROMA NISSAN: INTERSTAR 2002-2011, PRIMASTAR 2003-2012 RENAULT: ESPACE/GRAND ESPACE 2000-2002, ESPACE/GRAND ESPACEIV 2002-2009, LAGUNA II 2002-2007, MASTER II 2000-2011, TRAFIC II 2002-2012, VEL SATIS 2000-2009 VAUXHALL/OPEL: MOVANO-A 2000-2010, VIVARO-A 2002-2012, ASTRA-G 2000-2006, ASTRA-H 2006-2011, SIGNUM 2003-2008, VECTRA-B 2000-2002, VECTRA-C 2002-2008, VX220/SPEEDSTER 2000-2006, ZAFIRA-A 2000-2005, ZAFIRA-B 2005-2012
FERRAMENTAS OEM	KM-6077, KM-6148, 194A1000, 2.000.000.900
CÓDIGOS DE MOTOR	G9T 600, G9T 605, G9T 606, G9T 607, G9T 642, G9T 645, G9T 700, G9T 702, G9T 703, G9T 706, G9T 707, G9T 710, G9T 720, G9T 722, G9T 742, G9T 743, G9T 744, G9T 750, G9U 630, G9U 630, G9U 632, G9U 650, G9U 720, G9U 724, G9U 726, G9U 730, G9U 750, G9U 754, Z22SE, Z22YH, 194A1.000



53317

34,00€

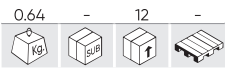

RETENTOR DA BOMBA DE LÍQUIDO DE REFRIGERAÇÃO OPEL/VAUXHALL 2.2

MARCAS	<p>FIAT: CROMA 2005-2011 NISSAN: INTERSTAR 2002-2011, PRIMASTAR 2003-2012 RENAULT: ESPACE/GRAND ESPACE 2000-2002, ESPACE/GRAND ESPACEIV 2002-2009, LAGUNA II 2002-2007, MASTER II 2000-2011, TRAFIC II 2002-2012, VEL SATIS 2000-2009 VAUXHALL/OPEL: MOVANO-A 2000-2010, VIVARO-A 2002-2012, ASTRA-G 2000-2006, ASTRA-H 2006-2011, SIGNUM 2003-2008, VECTRA-B 2000-2002, VECTRA-C 2002-2008, VX220/SPEEDSTER 2000-2006, ZAFIRA-A 2000-2005, ZAFIRA-B 2005-2012</p>
FERRAMENTAS OEM	KM-J-43651, 83 96 103
CÓDIGOS DE MOTOR	B207E, B207L, B207R, G9T 600, G9T 605, G9T 606, G9T 607, G9T 642, G9T 645, G9T 700, G9T 702, G9T 703, G9T 706, G9T 707, G9T 710, G9T 720, G9T 722, G9T 742, G9T 743, G9T 744, G9T 750, G9U 630, G9U 630 , G9U 632, G9U 650, G9U 720, G9U 724, G9U 726, G9U 730, G9U 750, G9U 754, Z20NET, Z22SE, Z22YH, 194A1.000



53452

26,50€

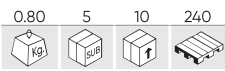

KIT DE BLOQUEIO OPEL/FORD/FIAT/ ALFA ROMEO/LANCIA/SUZUKI

MARCAS	<p>FIAT, ALFA ROMEO, LANCIA: 1.3 JTD MULTIJET FORD: 1.3 TDCI OPEL: AGILA, CORSA, COMBO (03-08), ASTRA H (05-08), MERIVA, TIGRA B (04-08) SUZUKI: 1.3 DDIS IGNIS, WAGON R (03-08), SWIFT (04-08)</p>
FERRAMENTAS OEM	EN46781, EN46785, EN-52137, MOT.1430, MOT1430, 0104A, 0132AJ1, 0187B, 0189B, 0194B, 991238300, 991768610, 991958120, 104A, 1860985000, 1871000900, 21263, 3031277, 3031472, 303735, 49JE02021, 607589011500, 9997122
CÓDIGOS DE MOTOR	AZWA, BHPA, C9DA/B, C9DC, DVTED4(8HV),, DVTED4(8HY), DVTED4(9HV), DV4C(8HP), DV4C(8HR), DV4TD(8HT), DV4TD(8HW), DV4TD(8HX), DV4TD(8HZ), DV4TED4(8HX), DV4TED(8H5), DV6ATED4(9HX), DV6ATED(9HX), DV6ATED(9HY), DV6AT(9HX), DV6AUTED4(9HX), DV6BTED4(9HT), DV6BTED4(9HW), DV6BUTED4(9HT), DV6CATED(9HX), DV6C(BHX), DV6C(BHZ), DV6CTED(9HC), DV6C(9HD), DV6C(9HL), DV6C(9HR), DV6DTE(9HF), DV6DTE(9HJ), DV6DTE(9HP), DV6D(9HP), DV6ETED(9HN), DV6TED4B, DV6TED4BU(9HS), DV6TED4B(9HV), DV6TED4(9HW), DV6TED4(9HW), DV6TE-D4(9HX), DV6TED4(9HY), DV6TED4(9HZ), DV6TED(9HD), DV6TED(9HP), DV6UTED4(9HU), DV6UTED4(9HX), DV6(9HR), DW10CTED4, FFBA, G6DA, FHZ(F13DTE5), F13DTE5 (FHZ), F6JA, F6JB, F6JC, G6DA, G6DB, G6DC, G8DA, G8DB,HHDA, HCBP, HCPA, HHDB, HHJA, HHJB, KKDA, MZ-CD, P7PA, P9PA, QXWA, QXWB, RHE, RTN, RTQ, RWPA, R2PA, R3PA, Y6, Z13DT, Z13DT , Z13DTH , Z13DTJ, 167A1.000 (FD4)BAAA/B, 169A1.000 , 188A8.000 , 188A9.000 , 199A3.000



53651

91,00€

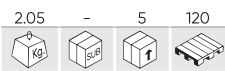

KIT DE BLOQUEIO AUDI OPEL/VAUXHALL 1.0, 1.2, 1.4 TURBO

MARCAS	<p>OPEL: ADAM, AMPERA, ASTRA J, AVEO, CORSA D, INSIGNIA, MERIVA B, MOKKA, ZAFIRA C TOURER</p>
FERRAMENTAS OEM	EN 49977-100, EN 49977-200, EN 49978, KM 952, KM 953-A, KM 955-1, KM 955-2
CÓDIGOS DE MOTOR	A10XEP (LDB), A12XEL (L2Q), A12XER (LDC), A14NEL (LDD), A14NEL (LUH), A14NEL (LUJ), A14NET (LUJ), A14XEL (L2Z), A14XER (LDD)LDU, 14XER (LDU), A14XFL (LUU), 12XEL (LWD)



54205

49,00€

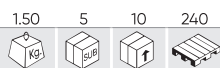

KIT DE BLOQUEIO DE DISTRIBUIÇÃO PARA VAUXHALL/OPEL 1.6 CDTI

MARCAS	VAUXHALL/OPEL: ASTRA J (13-18), ASTRA K, (15-19), GTC (15-18), INSIGNIA A (15-17), INSIGNIA- B (17-20), MERIVA B (13-17), MOKKA (14-16), MOKKA X (16-20), ZAFIRA C TOURER (13-19)
FERRAMENTAS OEM	EN-50513, EN-51140, EN-51143, EN-51188, EN-6130, EN-6349
CÓDIGOS DE MOTOR	B16DTC, B16DTE, B16DTH, B16DTJ, B16DTL, B16DTN, B16DTR, B16DTU, D16DTH, D16DTI, D16DTJ, D16DTN, D16DTR, D16DTU



54214

96,00€

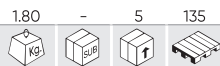

SET DE DISTRIBUIÇÃO PE OPEL/ISUZU 1.6D, 1.7D

MARCAS	OPEL/ISUZU: 1.6D, 1.7D
FERRAMENTAS OEM	KM 571A, KM 661, KM 661-2, KM 851, KM 951, VAS 6079, 23-029, 3313, 6079
CÓDIGOS DE MOTOR	TC4EE1, X17DTL4EC1, Y17DT, Y17DTL17DR, Z17DT, 4EC1, 4EE1, 4FC1, 4FD1, 4FG1, 4JA1, 4JB1, 4JG1, 4XJ1



54217

104,00€

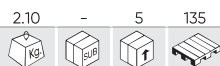

KIT DE BLOQUEIO DE DISTRIBUIÇÃO PARA VAUXHALL/OPEL/SAAB 2.0, 2.2 DTI

MARCAS	SAAB: 9-3 (98-04) 9-5 (02-06) VAUXHALL/OPEL: ASTRA-G (98-06), FRONTERA-B (98-04), OMEGA-B, (98-03), SIGNUM (03-05), SINTRA (98-99), VECTRA-B (97-02), VECTRA-C (02-05), ZAFIRA-A (99-05)
FERRAMENTAS OEM	KM 927, KM 929, KM 932, KM 933, 83 95 337, 83 95 352, 83 95 386, 83 95 394, 93 95 394
CÓDIGOS DE MOTOR	D223L, X20DTH, X20DTL, X22DYH, Y20DTH, Y20DTL, Y22DTH, Y22DTR



54221

111,00€

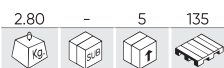

KIT DE BLOQUEIO DE DISTRIBUIÇÃO PARA VAUXHALL/OPEL 1.3 CDTI

MARCAS	OPEL: 1.3 CDTI
FERRAMENTAS OEM	EN-46775, EN-46785, EN-50515, EN-51500, KM-662-C, KM-955-1
CÓDIGOS DE MOTOR	LKU B13DTE, LKU B13DTR, LKV B13DTC



54434

48,50€

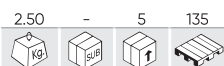

KIT DE BLOQUEIO OPEL 1.0, 1.4, 1.5

MARCAS	VAUXHALL/OPEL: ADAM 2014-2019, ASTRA-K 2015-2019, CORSA-E 2015-2019, INSIGNIA-B 2017-2020, MOKKA X 2016-2019, VIVA 2015-2020
FERRAMENTAS OEM	EN-51298, EN-51367, EN-51632
CÓDIGOS DE MOTOR	LE1/B10XFL, LE1/B10XFT, LE1/B10XHL, LE1/D10XFL, LE1/D10XFT, LE1/F10XFL, LE1/F10XFT, LE2/B14XFL, LE2/B14XFT, LE2/D14XFL, LE2/D14XFT, LFE/B14XNT, LFE/D14XNT, LFV/B15XHT, LFV/D15XHL, LFV/D15XHT, LV7/B14XE, LWT/B10XL, L5Q/B10XE, L5Q/D10XE



54435

14,50€

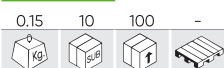

KIT DE BLOQUEIO OPEL/CHEVROLET/SAAB 1.4, 1.6, 1.8 ECOTEC

MARCAS	CHEVROLET: LACETTI (2005-2010), NUBIRA (2005-2010) OPEL/VAUXHALL: ASTRA-G (1998-2004), ASTRA-H (2004-2007), COMBO-C (2005-2012), CORSA-C (2000-2007), MERIVA-A (2003-2010), SIGNUM (2003-2007), TIGRA-B (2004-2010), VECTRA-B (1995-2002), VECTRA-C (2002-2008), ZAFIRA-A (1999-2005), ZAFIRA-B (2006-2013) SAAB: 9-3 (2003-2010)
FERRAMENTAS OEM	EN-852, KM 6130, KM 852, KM 911
CÓDIGOS DE MOTOR	F18D3, X14XE, X16SEJ, X16XEL, X18E1, X18XE1, Y16XE, Z14XE, Z16XE, Z16YNG, Z18XE, Z18XEL



54436

124,00€

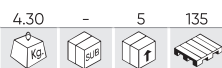

KIT DE BLOQUEIO OPEL 1.6 SIDI

MARCAS	VAUXHALL: ASTRA-J 2013-2017, ASTRA-K 2015-2019, CASCADA 2013-2019, GTC 2015-2019, INSIGNIA 2013-2017, INSIGNIA-B 2018-2020, ZAFIRA-C TOURER 2014-2019
FERRAMENTAS OEM	EN 50513, EN 51147, EN 51148, EN 51153
CÓDIGOS DE MOTOR	A16SHT, A16XHT, B16SHL, B16SHT, B16XHT, D16SHJ, D16SHL, D16SHT, LVP/A16XHT, LVP/B16XHT, LWC/A16SHT, LWC/B16SHL, LWC/B16SHT, LWC/D16SHJ, LWC/D16SHL, LWC/D16SHT



54437

110,00€

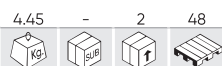

KIT DE BLOQUEIO OPEL/CHEVROLET/SAAB 2.0, 2.4

MARCAS	CHEVROLET: CAPTIVA 2011-2015, HHR 2008-2009, MALIBU 2012 - 2015 SAAB: 9-3 (02-12) 2010-2012, 9-5 (10-12) 2010-2012 VAUXHALL/OPEL: ANTARA 2011-2016, ASTRA-J 2012-2017, GTC (15-19) 2015-2019, INSIGNIA-A (08-17) 2008-2013
FERRAMENTAS OEM	EN 43653, EN 45027, EN 45027 1, EN 48953, EN 49212, EN 49212 2, EN 49212 2, EN 955 10, EN45027 2, EN-48585, EN-955-20, J 43653, J 45027 1, J 45027 2, KM 955, KM 955-20
CÓDIGOS DE MOTOR	A24XE (LE5), A24XF (LE9), LDK/A20NHT, LE5, LE9, LHU/A20NET, LHU/A20NFT, LHU/B20NFT



52271

18,00€

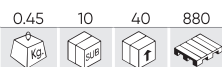

KIT DE BLOQUEIO DE DISTRIBUIÇÃO VAG

MARCAS	AUDI: A1/SPORTBACK 2010-2015, A2 2000-2006, A3/SPORTBACK 2002-2013, A4/QUATTRO/ALLROAD 2007-2015, A5/SPORTBACK 2008-2015, A6/QUATTRO 2002-2014, Q3 2011-2015, Q5 2008-2016, TT 2008-2014 SEAT: ALHAMBRA 2000-2015, ALTEA/ALTEA XL 2004-2015, CORDOBA 2002-2009, EXEO 2009-2013, IBIZA 2002-2015, LEON 2000-2013, TOLEDO 2000-2015 SKODA: FABIA 2003-2007, FABIA II 2007-2015, OCTAVIA/OCTAVIA TOUR 2002-2010, OCTAVIA II 2004-2013, PRAKTIK 2007-2015, RAPID/SPACEBACK 2012-2015, ROOMSTER 2006-2015, SUPERB 2005-2008, SUPERB II 2009-2015, YETI/OUTDOOR 2009-2017 VOLKSWAGEN: AMAROK 2010-2016, BEETLE 2002-2015, BORA 2002-2005, CADDY/CADDY MAXI 2004-2015, CRAFTER 2011-2017, EOS 2006-2015, FOX 2005-2011, GOLF PLUS 2005-2014, GOLF IV/ESTATE 2002-2006, GOLF V/ESTATE 2004-2009, GOLF VI/ESTATE 2008-2018, JETTA 2005-2016,
FERRAMENTAS OEM	EN-51418, MB995206, MB995208, MB995231, MP1301, T03006, T10050, T10060, T10060A, T10100, T10115, T20102, T20167, T40011, T40098, T40316, U40074, VM9882, VM9883, 0198-J, 10122, 114120, 23059, 303-1054, 310085, 3204, 3359, 9882
CÓDIGOS DE MOTOR	AJM, AMF, ANU, ARL, ASZ, ATD, ATL, AUY, AVB, AVF, AVF, AWX, AXB, AXC, AXR, AZV, BAY, BGW, BHC, BHW, BJB, BKC, BKD, BKP, BLB, BLS, BLT, BMA, BMM, BMN, BMP, BMR, BMS, BMT, BNA, BNM, BNV, BPW, BPX, BPZ, BRB, BRC, BRD, BRE, BRF, BRM, BRR, BRS, BRT, BSS, BST, BSV, BSW, BTB, BUK, BUY, BUZ, BVA, BVE, BVF, BVG, BVH, BVK, BWB, BWV, BXE, BXF, BXJ, CAAA, CAAB, CAAC, CAAD, CAAE, CAGA, CAGB, CAGC, CAHA, CAHB, CAYA, CAYB, CAYC, CAYD, CAYE, CBAA, CBAB, CBAC, CBBA, CBBB, CBDA, CBDB, CBDC, CCHA, CCHB, CDCA, CBGA, CFCA, CFFA, CFFB, CFFD, CFFE, CFGB, CFGC, CFGD, CFHA, CFHB, CFHC, CFHD, CFHE, CFHF, CFJA, CFJB, CFWA, CGLA, CGLB, CGLC, CGLD, CGLE, CJAA, CJCA, CJCB, CJCC, CJCD, CKTB, CKTC, CKUB, CKUC, CLCA, CLCB, CLJA, CLLA, CLLB, CLNA, CLSC, CMEA, CMFA, CMFB, CMGA, CMGB, CNEA, CNFA, CNFB, CSHA, CSLA, CSLB, CSNA



51489

12,00€

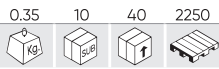

FERRAMENTA DE BLOQUEIO DA ÁRVORE DE CAMES VAG 1.4, 1.6

MARCAS	<p>AUDI: 80 1982-1996, 90 1986-1991, 100 1978-1994, 200 1982-2001, A2 2000-2006, A3 1993-2010, A4/QUATTRO 1994-2008, A6/QUATTRO 1994-2002, CABRIOLET 1995-2000</p> <p>SEAT: ALHAMBRA 1996-2010, ALTEA/ALTEA XL 2004-2013, AROSA 1999-2005, CORDOBA 1993-2009, EXEO 2009-2010, FABIA 1999-2007, IBIZA 1993-2015, INCA 1996-2004, LEON 1999-2013, OCTAVIA 1997-2012, TOLEDO 1994-2009</p> <p>SKODA: FABIA 1999-2015, OCTAVIA 1997-2013, PRAKTIK 2007-2015, ROOMSTER 2006-2015, SUPERB 2001-2008</p> <p>VOLKSWAGEN: BEETLE 1998-2011, BORA 1998-2005, CADDY 1980-2015, FOX 2005-2007, GOLF 1980-1999, GOLF2 1998-2013, JETTA 1980-1992, JETTA 2004-2017, LT 1982-1996, LUPO 1998-2005, PASSAT 1980-2010, POLO 1995-2014, SANTANA 1980-1988, SHARAN 1995-2010, TOURAN 20</p>
FERRAMENTAS OEM	80 1982, T10074
CÓDIGOS DE MOTOR	AAB, AAZ, ABL, ACL, ACT, AEF, AEH, AEY, AFK, AFN, AGD, AGP, AGR, AHB, AHF, AHG, AHH, AHL, AHU, AHW, AJA, AJM, AJV, AKL, AKQ, AKU, AKW, ALE, ALH, ALZ, AMF, ANA, ANU, ANY, APE, APF, APK, AQM, AQQ, AQQ, ARC, ARL, ARM, ARR, ASV, ASX, ASY, ASZ, ATD, ATJ, ATM, ATN, AUA, AUB, AUR, AUS, AUZ, AVB, AVF, AVG, AVU, AVY, AWH, AWX, AXA, AXP, AXR, AYD, AYQ, AYZ, AZD, AZH, AZJ, AZM, BAD, BBY, BBZ, BCA, BCB, BEH, BFQ, BFS, BGU, BKY, BSE, BSF, BSW, BSX, BUD, CCSA, CGGA, CGGB, CHGA, CMAA, CMXA, CR, CS, CY, DV, DW, JK, JP, JR, JX, KY, ME, RA, SB, 1G, 1S, 1V, 1X, 1Y, 1Z, 1,2 TDI PD, 1,4, 1,4 TDI PD, 1,6, 1,6 D/ Turbo, 1,7 SDI, 1,9 SDI, 1,9 SDI/ TDI, 1,9 TDI, 1,9 TDI PD, 2, 2,4 D



54454

182,50€

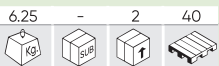

KIT DE BLOQUEIO AUDI 3.0 FSI/TFSI/RS

MARCAS	<p>AUDI: A6 (2018 - 2021), A8 (2017 - 2021), Q8 (2019 - 2021), RS4 (2017 - 2021), RS5 (2017 - 2021), S4 (2017 - 2020), S5 (2016 - 2020), SQ5 (2017 - 2020) & RS4 (2017 - 2021)</p>
FERRAMENTAS OEM	<p>T40331 T40331/1 T40331/2 T40331/4 T40331/5 T40331/9 T90000 T90001 T90002</p>
CÓDIGOS DE MOTOR	CWGD, CZSA, CZSE, DCBD, DECA, DLZA



54455

79,00€

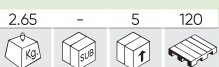

SAC POLIA DO EIXO-COMANDO DE VÁLVULAS VAG

MARCAS	<p>AUDI: A3 2.0L TDI 2010-2015, A6 3.0L TDI QUATTRO 2014-2015, A8 3.0L TDI QUATTRO 2014-2015, Q5 3.0L TDI 2014-2015, Q7 3.0L TDI 2009-2015.</p> <p>VW: BEETLE 1.9L TDI 1998/2005-2006, BEETLE 2.0L TDI 2013-2015, GOLF 1.9L TDI 1999/2004-2006, GOLF 2.0L TDI 2010-2015, JETTA 1.9L TDI 1997-2006, JETTA 2.0L TDI 2009-2015, TOUAREG 3.0L TDI 2009-2015</p>
FERRAMENTAS OEM	<p>T40001 T40001-6 T40001-7</p>
CÓDIGOS DE MOTOR	AEB, AHA, AKB, ALH, APB, APH, ART, ATC, ATQ, ATW, AUG, AUM, AUX, AWD, AWN, AWP



53274

30,50€

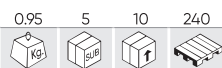

KIT DE BLOQUEIO VOLKSWAGEN/SEAT/SKODA 1,2L

MARCAS	SEAT: IBIZA, CORDOBA SKODA: FABIA VOLKSWAGEN: LUPO, POLO, EOS, FOX
FERRAMENTAS OEM	T10120, T10121, T10123
CÓDIGOS DE MOTOR	AWY, AZQ, BBM, BMD, BME, BVX, BZG, CEVA, CGPA, GPB, CGPC, CHFA, CHFB



53275

35,50€

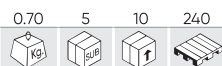

KIT DE BLOQUEIO VW-AUDI

MARCAS	AUDI: A1 (10-15), A2 (00-06), A3 (01-13), A4/ALLROAD (01-16), A5 (08-15), A6 (11-14), TT (08-14), Q3 (11-15), Q5 (08-15), A6 (10-14) DODGE: CALIBER (06-11) FORD: GALAXY (02-06) MITSUBISHI: GRANDIS (05-10), LANCER (05-10), OUTLANDER (07-10) SEAT: ALHAMBRA (00-15), ALTEA/ALTEA XL (04-15), CORDOBA (02-09), IBIZA (02-15), LEON (00-13), TOLEDO (04-11) SKODA: FABIA (00-14), FABIA II (07-15), OCTAVIA (00-10), OCTAVIA II (04-15), PRACTIK (10-15), RAPID (11-15), ROOMSTER (07-15), SUPERB (02-08), SUPERB II (08-15), YETI (09-14) VOLKSWAGEN: AMAROK (10-16), BEETLE (02-15), BORA (02-08), CADDY/MAXI (03-15), EOS (06-15), FOX (05-11), GOLF (02-15), GOLF PLUS (05-14), JETTA (05-15), LUPO (02-05), PASSAT/CC (02-15), POLO (99-14), SCIROCCO (08-14), SHARAN (02-15), TIGUAN (07-15), TOURAN (03-15), TRANSPORTER (03-17)
FERRAMENTAS OEM	EN-51418, MB995206, MB995208, MB995231, MP 1 301, T03006, T10050, T10060, T10060A, T10100, T10115, T20102, T20167, T40098, T40316, U40074, VM 9882, VM 9883, 0198-J, 10122, 11 4 120, 23 059, 303-1054, 310 085, 3204, 3359, 9882
CÓDIGOS DE MOTOR	AJM, AMF, ANU, ARL, ASZ, ATD, ATL, AUJ, AVB, AVF, AWX, AXB, AXC, AXR, AZV, BAY, BGW, BHC, BHW, BJB, BKD, BKP, BLB, BLS, BLT, BMA, BMM, BMN, BMP, BMR, BMS, BMT, BNA, BNM, BNV, BPW, BPX, BPZ, BRB, BRC, BRD, BRE, BRF, BRM, BRR, BRB, BSS, BST, BSV, BSW, BTB, BUK, BUY, BUZ, BVA, BVE, BVF, BVG, BVH, BVK, BWB, BWD, BVV, BXE, BXF, BXJ, CAAA, CAAB, CAAC, CAAD, CAAE, CAGA, CAGB, CAGC, CAHA, CAHB, CAYA, CAYB, CAYC, CAYD, CAYE, CBAA, CBAB, CBAC, CBBA, CBBB, CBDA, CBDB, CBDC, CCHA, CCHB, CDBA, CDCA, CECA, CFCA, CFFA, CFFB, CFFD, CFFE, CFGB, CFGC, CFGD, CFHA, CFHB, CFHC, CFHD, CFHE, CFHF, CFJA, CFJB, CFWA, CGLA, CGLB, CGLC, CGLD, CGLE, CJAA, CJCA, CJCB, CJCC, CJCD, CKTB, CKTC, CKUB, CKUC, CLCA, CLCB, CLJA, CLLA, CLLB, CLNA, CLSC, CMEA, CMFA, CMFB, CMGA, CMGB, CNEA, CNFA, CNFB, CSHA, CSLA, CSLB, CSNA



53278

143,00€



KIT DE BLOQUEIO AUDI 2.8, 3.2 FSI, 3.0 TFSI

MARCAS	VAG: 2.5, 2.8, 3.2 FSI, 3.0 TFSI
FERRAMENTAS OEM	T10035, T10172, T10172/2, T40058, T40069, T40071, T40133, T40133/1, T40133/1/2, T40133/2, 3212
CÓDIGOS DE MOTOR	BDX, CAJA, CAKA, CALA, CALB, CCAA, CCDA, CCEA, CGEA, CGFA, CGWA, CGWB, CGWC, CGWD, CGXB, CGXC, CHMA, CHMB, CHVA, CJBA, CJTA, CJTB, CJTC, CJWC, CLXB, CMDA, CMUA, CNA, CNYA, CPAA, CREA, CREC, CRED, CTUA, CTUD, CTVA, CTWA, CTWB, CTXA, M06/EC



53276

160,00€

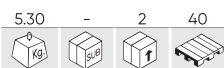

KIT DE BLOQUEIO AUDI SKODA

MARCAS	AUDI/SKODA: 2.0, 2.8, 3.0
FERRAMENTAS OEM	T10008, T10016, T10020, T10050, T10060A, T10092, T10098, T10100, T10120, T10121, T10123, T10264, T10265, T40011, 2064, 2065A, 3078, 3242, 3359, 3366, 3369, 3418, 3458, 3551
CÓDIGOS DE MOTOR	ACV, AHY, AJ, AJM, AMF, ANU, ANY, ARL, ASZ, ATD, ATJ, ATL, AUY, AVB, AVQ, AVX, AWW, AXB, AXC, AXG, AXL, AXR, AYC, AYZ, AZU, AZV, BAY, BDJ, BDK, BGW, BHC, BHW, BJB, BKC, BKD, BMM, BMN, BMP, BMS, BNM, BNV, BRM, BRU, BST, BSU, BTB, BVK, BWB, BXE, BXF



53277

45,00€

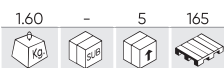

JOGO DE CHAVES PARA TENSOR DA CORREIA DE DISTRIBUIÇÃO VW E AUDI

MARCAS	1.2 TDI, 1.4 TDI, 1.5 D, 1.6D, 1.7 SDI, 1.9 TDI, 2.0 TDI, 2.5 TDI 1.6L, 1.8L, 1.8LT, 1.8LT 16V, 2.0L, 2.0L 16V, 2.0L FSI/TSI
FERRAMENTAS OEM	T10020, T10060, T100604, T10115, T40011, V159, 3387
CÓDIGOS DE MOTOR	AAB, AAC, AAE, AAZ, ABF, ABK, ABL, ABM, ABS, ABT, ACE, ACV, ADA, ADL, ADP, ADR, ADY, ADZ, AEB, AEF, AEG, AEH, AEK, AEY, AFF, AFN, AFT, AGD, AGG, AGN, AGP, AGR, AGU, AHB, AHF, AHG, AHH, AHL, AHU, AJH, AJL, AJP, AJQ, AKL, AKS, AKT, AKU, AKW, ALE, ALH, ALZ, AMK, ANA, ANB, APF, APG, APK, APP, APT, APU, APX, APY, AQA, AQM, AQX, AQY, ARG, ARM, ARX, ARY, ARZ, ASV, ASX, ASY, ATM, ATU, AUM, AUQ, AUR, AVC, AVG.1V, AVU, AWC, AWF, AWG, AWP, AWT, AWU, AWW, AWX, AXA, AXX, AYD, AYP, AYQ, AZH, AZJ, AZL, AZM, BAM, BEH, BFQ, BFS, BGB, BGU, BHD, BJJ, BJK, B JL, BJM, BLR, BLY, BMB, BPJ, BPY, BSE, BSF, BWA, CS, CY, DE, MD, ME, MF, 1F, 1Y, 1Z, 2E



NOVO MOTOR DE BUSCA NA WEB PARA KITS DE FERRAMENTAS DE TEMPORIZAÇÃO DE MOTORES

Descubra a nossa nova ferramenta online: um novo localizador de kits para encontrar o que precisa!

Aceda ao nosso website e localize a secção de procura de kits de regulação no menu principal.

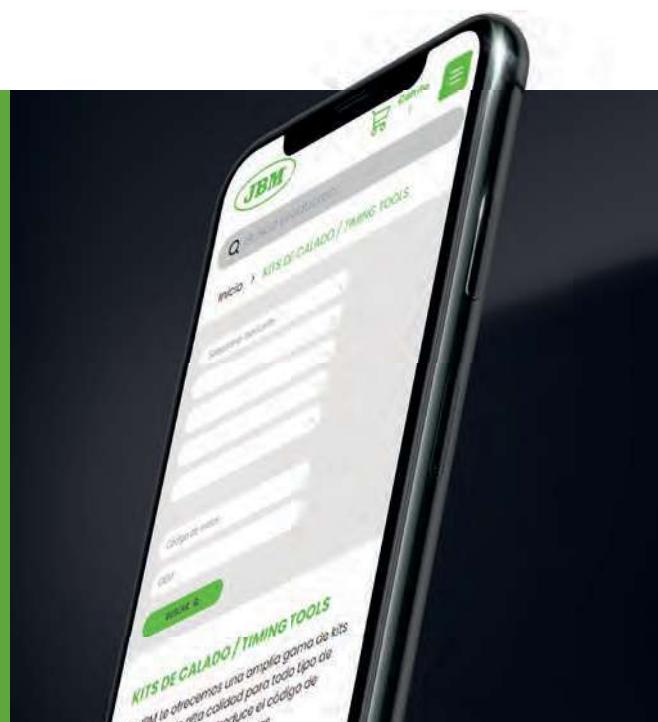

53279

97,00€

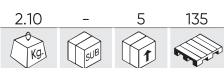

KIT DE BLOQUEIO VW/AUDI 1.8, 2.0, TSI, TFSI

MARCAS	<p>AUDI: A3 1996-2009, A4 1994-2009, A6 1995-2011, S3 1999-2013, TT 1998-2014 SEAT: ALHAMBRA 1997-2010, ALTEA/ALTEA XL 2006-2009, CORDOBA 1999-2002, EXEO 2009-2010, IBIZA 1999-2002, LEON 1999-2013, TOLEDO 1999-2009 SKODA: OCTAVIA/OCTAVIA TOUR 1998-2010, OCTAVIA II 2004-2009 VOLKSWAGEN: BEETLE 1999-2011, BORA 1997-2004, EOS 2006-2010, GOLF 1997-2012, GOLF PLUS 2005-2009, JETTA 2005-2009, PASSAT 2996-2010, SCIROCCO 2009-2014, SHARAN 1997-2010, TOURAN 2003-2009</p>
FERRAMENTAS OEM	T10020, T10060, T10060A, T10092, T10115, T10252, T20018, T20044, T20167, T40011, T40098, V 159, 3204, 3366
CÓDIGOS DE MOTOR	AWA, AXW, AXJ, BGB, BHD, BHZ, BLR, BLX, BLY, BMB, BPG, BPJ, BPY, BUL, BVX, BVY, BVZ, BWA, BWE, BWJ, BWT, BYD, BYK, BZC, CDLA, CDLB, CDLC, CDLD, CDLF, CDLG, CDLJ, CDLK, CDMA



53280

112,00€

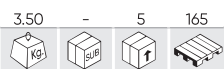

KIT DE FERRAMENTAS DE SINCRONIZAÇÃO VAG 3.0 V6

MARCAS	AUDI: A4/QUATTRO/CABRIO 2001-2008, A6/QUATTRO 2001-2008, A8 2001-2008
FERRAMENTAS OEM	T40011, T40026, T40028, T40030, 3387
CÓDIGOS DE MOTOR	ASN, AVK, BBJ, BGN



53281

55,00€

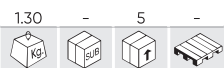

SET DE ALINHAMENTO EIXO DE COMANDO VW/AUDI

MARCAS	VOLKSWAGEN/AUDI: 2.5 TDI V6
FERRAMENTAS OEM	T20102, T30052, T30092, T30094, T40011, T40237, 3078, 3242, 3359, 3369, 3458
CÓDIGOS DE MOTOR	AFB, AKE, AKN, AYM, BAU, BCZ, BDG, BDH, BFC



53282

48,00€

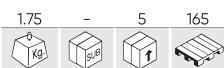

KIT DE BLOQUEIO VAG 1.2, 1.4, 1.6

MARCAS	VAG: 1.2, 1.4, 1.6
FERRAMENTAS OEM	T10170, T10171, T10171A, T10340, T10414, T40011
CÓDIGOS DE MOTOR	AXU, BAG, BKG, BLF, BLG, BLN, BLP, BMY, BTS, BWK, CAVA, CAVB, CAVC, CAVD, CAVE, CAVF, CAVG, CAXA, CAXC, CBZA, CBZB, CBZC, CDGA, CKMA, CLRA, CMSA, CMSB, CNVA, CTHA, CTHB, CTHC, CTHD, CTHE, CTHF, CTHG, CTJB, CTJC, CTKA



53283

92,00€



KIT DE BLOQUEIO GRUPO VAG 2.7, 3.0 TDI

MARCAS	VAG: 2.7, 3.0 TDI
FERRAMENTAS OEM	MP 1 301, T20102, T30052, T40049, T40058, T40060, T40061, T40062, T40237, U40074, VM 9882, 3242, 3359, 9882
CÓDIGOS DE MOTOR	ASB, BKN, BKS, BMK, BMZ, BNG, BPP, BSG, BUG, BUN, BWZ, CAM, CAMB, CANA, CANB, CANC, CAND, CAPA, CARA, CARS, CASA, CASC, CASE, CAWA, CCHA, CCWA, CCWB, CDVB, CDVC, CDYA, CEXA, CGKA, CGKB, CRT, CRTC, CRTD, CRTE, CRTF



53284

306,00€



KIT DE BLOQUEIO GRUPO VAG 2.5 TDI

MARCAS	VAG: 2.5 TDI
FERRAMENTAS OEM	T10193, 10194, T10199, T10199/01, T10225, T10226, T10234
CÓDIGOS DE MOTOR	AXD, AXE, AYH, BAC, BLE, BLJ, BLK, BNZ, BPC, BPD, BWF, FMB



53285

56,00€

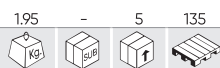

KIT DE BLOQUEIO VAG 2.4, 2.5, SDI, TDI

MARCAS	VAG: 2.4, 2.5 SDI, TDI
FERRAMENTAS OEM	MP 1 300, T10025, U40021, 2065A, 21 105, 3355, 3419, 5190, 999 5190, 999 5649
CÓDIGOS DE MOTOR	ACV, AGX, AHD, AHY, AJT, ANJ, APA, AUF, AVR, AXG, AXL, AYC, AYY, BBE, BBF, D5252T



53286

87,00€

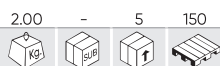

KIT DE BLOQUEIO VAG 1.8, 2.0 TSI, TFSI

MARCAS	VOLKSWAGEN: 1.8, 2.0TSI / TFSI
FERRAMENTAS OEM	T10060A, T10352, T10352/1, T10352/2, T10354, T10368, T40011, T40098, T40196, T40267, T40271
CÓDIGOS DE MOTOR	BYT, BZB, CABA, CABB, CABD, CADA, CAEA, CAEB, CAWA, CAWB, CBFA, CCTA, CCZA, CCZB, CCZC, CDA, CDAB, CDHA, CDHB, CDNB, CDNC, CDND, CESA, CETA, CFKA, CGYA, CJBA, CJEB, CJSB



53287

245,00€



KIT DE BLOQUEIO VW/AUDI 1.8, 2.0L TURBO

MARCAS	VOLKSWAGEN/AUDI: 1.8, 2.0 TSI, TFSI
FERRAMENTAS OEM	T10060A, T10352, T10352/1, T10352/2, T10354, T10368, T40011, T40098, T40196, T40267, T40271
CÓDIGOS DE MOTOR	BYT, BZB, CABB, CABD, CADA, CAEA, CAEB, CAWA, CAWB, CBFA, CCTA, CCZA, CCZB, CCZC, CDA, CDAB, CDHB, CDNB, CDNC, CDND, CESA, CETA, CFKA, CGYA, CJEB, CJS, CJSB



53288

72,00€

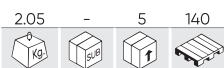

KIT DE BLOQUEIO VAG 1.6, 2.0 TDI COMMON RAIL

MARCAS	VAG: 1.6, 2.0 TDI
FERRAMENTAS OEM	MB995206, MB995231, MP 1 301, T100255, T10050, T10051, T10052, T10100, T10264, T10265, T20102, T40098, U40074, VM 9882, VM 9883, 10122, 23 059, 310 085, 3359, 9882
CÓDIGOS DE MOTOR	CAAA, CAAB, CAAC, CAAD, CAAE, CAGA, CAGB, CAGC, CAHA, CAHB, CAYA, CAYB, CAYC, CAYD, CAYE, CBAA, CBAB, CBAC, CBBA, CBBB, CBDA, CBDB, CBDC, CCHA, CCHB, CDBA, CDCA, CECA, CFCA, CFFA, CFFB, CFFD, CFFE, CFGB, CFGC, CFGD, CFHA, CFHB, CFHC, CFHD, CFHE, CFHF, CFJA, CFJB, CFWA, CGLA, CGLB, CGLC, CGLD, CGLE, CJAA, CJCA, CJCB, CJCC, CJCD, CKTB, CKTC, CKUB, CKUC, CLCA, CLCB, CLJA, CLLA, CLLB, CLNA, CMEA, CMFA, CMFB, CMGB, CNEA, CNFA, CNFB, CSHA, CSLB, CSNA



53648

107,00€

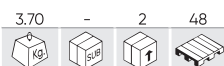

KIT DE BLOQUEIO DE DISTRIBUIÇÃO PARA VAG 1.0, 1.2, 1.4 TSI

MARCAS	AUDI: A1 (12-15), A1 SPORTBACK (12-15), A3 (13-15), A3 SPORTBACK (12-15) SEAT: IBIZA (12-15), LEON (12-15), TOLEDO (12-15) SKODA: FABIA (10-13), OCTAVIA II (10-13), OCTAVIA III (10-15)
FERRAMENTAS OEM	T10060A, T10340, T10476, T10477, T10487, T10494, T10499, T10501/1, T10504, T10504/2
CÓDIGOS DE MOTOR	CHPA, CHPB, CHYE, CHZJ, CHZL, CJZA, CJZB, CJZC, CJZD, CMBA, CPGA, CPTA, CPVA, CPVB, CPWA, CRJA, CUKB, CUKC, CVNA, CWVA, CWVB, CXSA, CXSB, CYVA, CYVB, CYVD, CZCA, CZCC, CZDA, CZDB, CZEA, CZIA, DAFA, DJKA



53649

89,00€



SET DE DISTRIBUIȚIE PE GRUPO VAG

MARCAS	AUDI SEAT SKODA VOLKSWAGEN
FERRAMENTAS OEM	T10340, T10476, T10477, 10487, T10494, T10499
CÓDIGOS DE MOTOR	CHPA, CHYA, CHYB, CHZA, CHZB, CHZC, CHZD, CHZE, CHZJ, CJZA, CJZB, CJZC, CJZD, CMBA, CPTA, CVNA, CYVA, CYVB, CZCA, CZCC, CZDA, CZIA



53326

16,00€

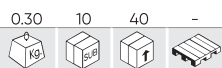

KIT DE BLOQUEIO VW/AUDI

MARCAS	AUDI: A4/ A4 QUATTRO 1997-2008, A4 CABRIO 2003 -2009, A6/ A6 QUATTRO 1997-2005, A6 ALLROAD 2000-2005, A8 1997-2002 SKODA: SUPERB 2002-2008
FERRAMENTAS OEM	3242, 3458
CÓDIGOS DE MOTOR	AFB, AKE, AKN, AYM, BAU, BCZ, BDG, BDH, BFC



53327

11,00€

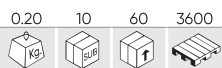

KIT DE BLOQUEIO VAG 1.2

MARCAS	SEAT: IBIZA1.2 6V/3CYL (2002-09), CORDOBA 1.2 12V/3CYL (2002-13) SKODA: FABIA 1.2 6V-12V/3CYL (2002, 2003-), FABIA II 1.2 6V/3CYL (2007-13), ROOMSTER 1.2 12V/3CYL (2006-13), PRAKTIK 1.2 6V/3CYL (2007-13) VW: POLO 1.2 6V-12V/3CYL (2002-14)
FERRAMENTAS OEM	T10123
CÓDIGOS DE MOTOR	AWY, AZQ, BBM, BMD, BME, BXV, BZG, CEVA, CGPA, CGPB, CGPC, CHFA, CHFB



53320

12,00€

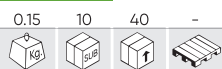

CONJUNTO DE FERRAMENTAS DE TEMPO PARA VAG

MARCAS	AUDI: A2 2001-2006, A3 2001-2002, A4/QUATTRO 1999-2002, A6/QUATTRO 1998-2002 SEAT: ALHAMBRA 1999-2010, AROSA 1999-2005, LEON 2000-2005, TOLEDO 2000-2005 SKODA: FABIA 2000-2005, OCTAVIA/OCTAVIA TOUR 2000-2006, SUPERB 2002-2002 VOLKSWAGEN: BEETLE 2000-2011, BORA 1998-2002, GOLFIV 1998-2002, LUPO 1999-2005, PASSAT 1998-2002, POLO 1999-2002, SHARAN 1999-2002
FERRAMENTAS OEM	T10008, T10100, T20102
CÓDIGOS DE MOTOR	AJM, AMF, ANU, ANY, ARL, ASZ, ATD, ATJ, ATL , AUY, AVB, AVF, AWX, AXR, AYZ, BHC, BSW, BTB, BVK



54408

46,00€

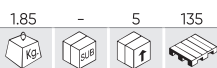

CONJUNTO DE FERRAMENTAS DE BLOQUEIO DO MOTOR VAG DIESEL 1.7, 1.9, SDI, TDI

MARCAS	<p>AUDI: A3, A4, A6, CABRIOLET, SEAT: ALHAMBRA, AROSA, CORDOBA, IBIZA, INCA, LEON, TOLEDO, SKODA: FELICIA, OCTAVIA VOLKSWAGEN: BORA, CADDY, FOX, GOLF, LT, LUPO, PASSAT, POLO, SHARAN, TRANSPORTER, VENTO</p>
FERRAMENTAS OEM	T10020, T10092, T10098, T20038, T20044, T20102, T40011, 1302, 2064, 2065A, 3359
CÓDIGOS DE MOTOR	AAC, AAE, AAZ, ABF, ABK, ABL, ABS, ACE, ACL, ACT, ADL, ADR, ADY, ADZ, AEB, AEF, AEG, AEY, AFF, AFN, AFY, AGD, AGG, AGN, AGP, AGR, AGU, AHB, AHF, AHG, AHH, AHU, AJH, AJL, AJP, AJQ, AKT, AKU, AKW, ALE, ALH, AMK, AMU, ANB, APG, APJ, APK, APP, APT, APU, APX, APY, AQA, AQE, AQM, AQX, AQY, ARG, ARH, ARX, ARY, ARZ, ASV, ASX, ASY, ATM, ATU, AUM, AUG, AVC, AVG, AVV, AWC, AWF, AWG, AWT, AWU, AXA, AXW, AXX, AYP, AYQ, AZG, AZH, AZJ, AZL, AZM, BAM, BBX, BEH, BFV, BGB, BHD, BLR, BLY, BMB, BPJ, BPY, BSX, BVP, BVR, BWA, DV, DW, KY, 1G, 1S, 1X, 1Y, 1Z, 2E



54409

32,00€

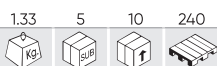

KIT DE BLOQUEIO VAG 1.4 TSI

MARCAS	<p>AUDI: A1/A1 SPORTBACK (8XA/8X1)(8XF/8XK) 2012-2018, A3 (8V) 2012-ON, Q2 (GAB) 2016-ON, Q3 (8UG) 2015-2018 SEAT: ATECA (KH7) 2016-ON, IBIZA (6J/6P) 2013-2017, LEON/LEON ST (5F) 2012-2020 SKODA: KODIAQ (NS7) 2017-ON, SUPERB (3V3/3V5) 2015-ON VOLKSWAGEN: GOLF VII (5G1) 2012-2017, PASSAT (3G2/3G5) 2014-ON, POLO MK5 (6C1)(6R1) 2012-2018</p>
FERRAMENTAS OEM	T10340, T10504, T10504/1, T10504/2
CÓDIGOS DE MOTOR	CPTA, ZEA



54410

33,50€



KIT DE BLOQUEIO VAG 2, 3.2 FSI

MARCAS	<p>AUDI: A4, A5, A6, A7, A8, Q5, Q7, R8, RS4, RS5, RS6, S4, S5, S6, S8 VOLKSWAGEN: TOUAREG (2010-2014)</p>
FERRAMENTAS OEM	T40058, T40069, T40071, T40133, T40133/1, T40133/1/2, T40133/2, 40071
CÓDIGOS DE MOTOR	AUK, BAR, BDW, BKH, BNS, BPK, BSM, BUH, BUJ, BVJ, BXA, BYH, CAUA, CDRA, CFSA, CMPA, CNDA, CTPA, CTYA



54411

36,00€

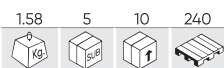

KIT DE BLOQUEIO VAG/PORSCHE 2.4, 2.8, 3.0 TFSI

MARCAS	AUDI: A4 (2011-2015), A5 (2007-2017), A6 (2007-2018) A7 (2010-2018) A8 (2010-2018) A8 (2010-2018) Q7 (2010-2018) S4 (2009-2017) S5 (2010-2017) S5 (2010-2017) Q5 (2008-2017) SQ5 (2013-2018) PORSCHE: CAYENNE 2010-2014, PANAMERA 2011-2013 VAG: TOUAREG 2010-2014
FERRAMENTAS OEM	T40058, T40069, 40071, T40133, T40133/1, T40133/1/2, T40133/2, 40071
CÓDIGOS DE MOTOR	BDX, CAJA, CAKA, CALA, CALB, CCAA, CCDA, CCEA, CGEA, CGFA, CGWA, CGWB, CGWC, CGWD, CGXB, CGXC, CHMA, CHMB, CHVA, CJBA, CJTA, CJTB, CJTC, CJWC, CLXB, CMDA, CMUA, CNA, CNYA, CCAA, CREA, CREC, CRED, CTTA, CTUA, CTUD, CTVA, CTWA, CTWB, CTXA, M06/EC



54412

57,00€

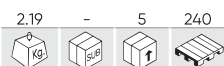

KIT DE BLOQUEIO AUDI 2.5 TFSI

MARCAS	AUDI: TT (2016 - 2018), Q3 & Q3 RS (2019-), RS3 SALOON, (2016 - 2018) & RS3 SPORTBACK (2016 - 2018)
FERRAMENTAS OEM	T03003, T40011, T40069, T40264 12, T40264 2A, T40297
CÓDIGOS DE MOTOR	CEPA, CEPB, CTSA, CZGA, CZGB



54413

115,00€

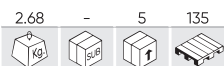

KIT DE BLOQUEIO AUDI 4.0 FSI, TFSI

MARCAS	AUDI: A8, RS6, RS7, S6, S7, S8 (2012-2018)
FERRAMENTAS OEM	T40071, T40257, T40264/1, T40264/2, T40264/3, T40269, T40272
CÓDIGOS DE MOTOR	CEUA, CEUC, CGTA, CRDB, CTFA, CTGA, CTGE, CWUB, CWUC, DDTA



54431

184,00€

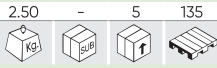

KIT DE BLOQUEIO ALFA ROMEO/MASERATI 2.9

MARCAS	ALFA ROMEO: GIULIA, STELVIO MASERATI: 3.8T
FERRAMENTAS OEM	1860815000, 2024000090, 2024100000
CÓDIGOS DE MOTOR	670050436, 670051007, 670052721, 670052722



53315

285,00€

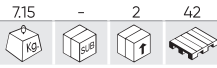

SET DE BLOQUEIO VOLVO 3.0, 3.2T6 / LAND ROVER 3.2

MARCAS	LAND ROVER: FREELANDER II (11-14) VOLVO: S60 (10-16), S80 (07-15), XC60 (08-15), XC70 (06-15), XC 90 (10-14), V60 (10-15), V70 (10-15)
FERRAMENTAS OEM	303-1219, 303-1225, 303-1226, 303-1233, 999-7257, 999-7261, 999-7263, 999-7264, 999-7272
CÓDIGOS DE MOTOR	B6304T2, B6304T4, B6324S, B6324S5



54226

71,00€

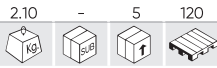

CONJUNTO DE EXTRATOR PARA POLIA DA BOMBA DE ALTA PRESSÃO PARA HYUNDAI/KIA

MARCAS	HYUNDAI: ACCENT (11-15), ELANTRA (07-10), I20 (09-18), IX20 (10-18), I20 COUPE (15-17), I30 (07-19), IX35 (10-16), I40 (11-18) KIA: CARENS (13-18), CEED (07-18), OPTIMA (11-15), PRO-CEED (08-19), RIO (09-17), CERATO (05-07), SOUL (09-14), SPORTAGE (10-18), VENGA (09-18)
FERRAMENTAS OEM	09331-2A000, 09331-2A010
CÓDIGOS DE MOTOR	D3FF, D4FB-H(U1), D4FB-H(U2), D4FB-L(U1), D4FB(U1), D4FB(U2), D4FC(U1), D4FC(U2), D4FD-H(U2), D4FD-L, D4FD-L(U2), D4FD(U2)



54200

56,00€

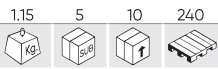

KIT DE BLOQUEIO DE DISTRIBUIÇÃO PARA PORSCHE

MARCAS	PORSCHE: 911 (01-08), BOXTER (02-11), CAYMAN (06-09)
FERRAMENTAS OEM	9595, 9595/1, 9685, 9686
CÓDIGOS DE MOTOR	M96/03, M96/05, M96/23, M96/24, M96/24S, M96/25, M96/26, M97/01, M97/015, M97/20, M97/21, M97/22



51340

39,30€

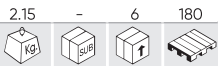

CHAVE UNIVERSAL PARA ÁRVORE DE CAMAS + ADAPTADORES

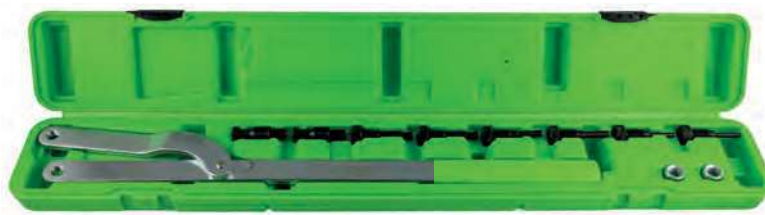

51927

25,00€

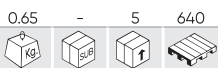

DESMONTADOR E TENSOR DE CORREIAS EN POLI-V



52616

44,00€

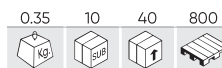

TENSIÔMETRO PARA CORREIA DE TRANSMISSÃO



54199

94,00€

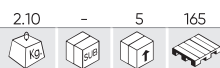

KIT DE BLOQUEIO DE DISTRIBUIÇÃO PARA VAG TFSI, FSI

MARCAS	<p>AUDI: A1 (10-15), A1 SPORTBACK (10-15), A3 CABRIOLET (10-13), A3 (10-15), A3 SPORTBACK (03-13)</p> <p>SEAT: ALTEA/ALTEA XL (10-15), IBIZA (10-15), LEON (10-13), TOLEDO (12-15)</p> <p>SKODA: FABIA II (10-15), PRAKTIK (10-15), RAPID (12-15), RAPID SPORTBACK (12-15), OCTAVIA II (04-13), YETI (09-15), YETI OUTDOOR (13-15)</p> <p>TIGUAN (07-15), TOURAN (03-15)</p> <p>VOLKSWAGEN: BEETLE (11-15), CADDY/CADDY MAXI (10-15), EOS (07-15), GOLF V (03-13), GOLF V ESTATE (07-09), GOLF VI (10-13), GOLF VI ESTATE (10-13), GOLF VI CABRIOLET (11-15), GOLF PLUS (05-14), JETTA (05-14), PASSAT (05-15), POLO (09-14), SCIROCCO (08-14)</p>
FERRAMENTAS OEM	T10170, T10171/, T10171A, T10340, T10414, T40011, VAS6079
CÓDIGOS DE MOTOR	BAG, BLF, BLG, BLP, BMY, BWK, CAVA, CAVB, CAVC, CAVD, CAVE, CAVF, CAXA, CAXC, CBZA, CBZB, CBZC, CDGA, CSMA



54407

397,00€

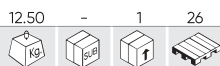

KIT DE FERRAMENTAS PARA O CONJUNTO DO EIXO-COMANDO DE VÁLVULAS VAG/PORSCHE

MARCAS	<p>AUDI: A1 (10-15), A1 SPORTBACK (10-15), A3 (08-13), A3 CABRIOLET (08-13), A3 SPORTBACK (08-13), A4 (07-15), A4 ALLROAD (09-15), A4 CABRIOLET (05-09), A4 QUATTRO (05-15), A5 (08-15), A5 CABRIOLET (07-15), A5 COUPE (07-15), A5 SPORTBACK (09-15), A6 (08-14), A6 AL</p> <p>PORSCHE: CAYENNE (09-15), MACAN (14-15), PANAMERA (13-14)</p> <p>SEAT: ALHAMBRA (10-15), ALTEA/ALTEA XL (09-15), EXEO (09-13), IBIZA (09-15), LEON (09-15)</p> <p>SKODA: FABIA II (09-15), OCTAVIA II (08-15), PRAKTIK (10-12), PRAKTIK GREENLINE (10-15), RAPID (12-15), ROOMSTER (10-15), SUPERB II (08-15), SUPERB II GREENLINE (10-15), YETI (09-13), YETI GREENLINE (10-13)</p> <p>VW: BEETLE (11-15), BEETLE CC (12-15), CADDY/CADDY MAXI (09-15), EOS (08-15), GOLF V ESTATE (07-11), GOLF VI (08-13), GOLF VI BLUEMOTION (09-13), GOLF VI CABRIOLET (11-15), GOLF VI ESTATE (08-15), GOLF VII (13-15), GOLF PLUS (08-14), JETTA (08-15), PASSAT (08)</p>
FERRAMENTAS OEM	T40094, T40094/1, T40094/10, T40094/11, T40094/2, T40094/9, T40095, T40096/1
CÓDIGOS DE MOTOR	VSE5951, VSE5952, VSE6181, CFWA, CAYA, CAYB, CAYC, CAYD, CAYE, CEGA, CLNA, CRKB, CAYA, CAYB, CAYC, CAYD, CAYE, CEGA, CLNA, CRKB, CDCA, CKTB, CBAB, CFGB, CAAA, CAAB, CAAC, CAAD, CAAE, CAGA, CAGB, CAGC, CAHA, CAHB, CAYB, CBAA, CBAB, CBAC, CBBA, CBBB, CBDA, CBDDB, CBDC, CCHA, CCHB, CDBA, CFCA, CEGA, CFFA, CFFB, CFFE, CFGB, CFGC, CFGD, CFHA, CFHB, CFHC, CFHD, CFHE, CFHF, CFJA, CGLA, CGLB, CGLC, CGLD, CJAA, CJC, BPP, CANC, CAMA, CANA, CGKA, ASB, BNG, CASA, CASB, CASD, CAPA, CARA, CASD, CCMA, CCWA, CCWB, CDUC, CDYA, CDYB, CDYC, CDTA, CDTB, CDUD, CEXA, CJMA, CJGD, CJMA, CRCA, CLAA, CLAB, CMHA, CRCA, MCT.BA, CTB, MCR.CC, M059D, M059E, ASE, CCFA, CCFC, CDSB, MCU.DB



54218

142,00€



FERRAMENTA DE MONTAGEM DE AMORTECEDOR DE VIBRAÇÃO VAG

MARCAS	<p>AUDI</p> <p>SEAT</p> <p>SKODA</p> <p>VOLKSWAGEN</p>
FERRAMENTAS OEM	T10531/1, T10531/2, T10531/3, T10531/4
CÓDIGOS DE MOTOR	BPU, BYT, BZB, CABA, CABB, CABD, CAWB, CBFA, CCTA, CCZA, CCZB, CCZC, CDAA, CDHA, CDHB, CDNB, CDNC, CESA, CETA, CFKA, CHHB, CHHC, CHJA, CJEB, CJED, CJEE, CJSB, CJXA, CJXB, CJXC, CJXD, CJXE, CJXF, CJXG, CNCB, CNCD, CNCE, CPSPA, CULB, CULC, CVKB, CVLA, CWZA, CYGA, CYNB, CYPA, CYPB, CYRB, CYRC, CZPB, DAJB, DAXB, DEMA, DJHA, DJHB, DKYA, DKZA, DKZB, DKZC, DLVA, DLVB



53769

195,00€

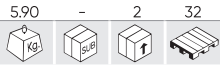

MÓDULO DE BLOQUEIO RENAULT /NISSAN/
OPEL/VOLVO



MARCAS	<p>DACIA: DOKKER, DUSTER, LOGAN, SANDERO NISSAN: ALMERA, INTERSTAR, KUBISTAR, MICRA, NOTE, PRIMERA, QASHQAI OPEL /VAUXHALL: MOVANO, VIVARO RENAULT: AVANTIME, CLIO, ESPACE, KANGOO, LAGUNA, MASTER, MEGANE, MODUS, SCENIC, TWINGO, TRAFFIC VOLVO: S40, V40</p>
FERRAMENTAS OEM	<p>B0280, KM-6031, KM-6203, KM-6204, KM-6205, KM-6234, KV113, KV113 B0130, KV113 B0360, MOT 1054 , MOT 1135-01, MOT 1200-01, MOT 1312, MOT 1318, MOT 1337, MOT 1340, MOT 1348, MOT 1384, MOT 1386, MOT 1489, MOT 1490-01, MOT 1496, MOT 1534, MOT 1536, MOT 1537 , MOT 1538, MOT 1543, MOT 1750, MOT 910</p>
CÓDIGOS DE MOTOR	<p>D4F701, D4F702, D4F706, D4F708, D4F710, D4F712, D4F714, D4F716, D4F720, D4F722, D4F726, D4F728, D4F730, D4F740, D4F744, D4F746, D4F764, D4F766, D7F700, E5F, E6J, E7F700, E7F704, E7F706, E7F750, E7J601, E7J624, E7J626, E7J634, E7J635, E7J680, E7J700, E7J706, E7J710, E7J711, E7J716, E7J718, E7J719, E7J720, E7J724, E7J726, E7J728, E7J740, E7J742, E7J745, E7J754, E7J756, E7J757, E7J764, E7J770, E7J771, E7J773, E7J780, F1N, F2N, F2R, F3N, F3P, F3P670, F3P682, F3P700, F3P704, F3P706, F3P708, F3P710, F3P712, F3P714, F3P720, F3P722, F3P724, F3P755, F3P758, F3P760, F3R, F3R611, F3R722, F3R723, F3R728, F3R729, F3R750, F3R751, F3R752, F3R791, F3R796, F3R797, F3R798, F4P, F4R, F5R700, F5R701, F5R740, F7F704, F7R710, F7R714, F8M736, F8M760, F8Q600, F8Q606, F8Q610, F8Q620, F8Q622, F8Q624, F8Q630, F8Q632, F8Q640, F8Q644, F8Q646, F8Q648, F8Q662, F8Q672, F8Q678, F8Q680, F8Q682, F8Q684, F8Q692, F8Q696, F8Q706, F8Q714, F8Q720, F8Q722, F8Q730, F8Q732, F8Q740, F8Q742, F8Q744, F8Q764, F8Q768, F8Q776, F8Q784, F8Q786, F8Q788, F9Q610, F9Q650, F9Q664, F9Q670, F9Q674, F9Q715, F9Q716, F9Q717, F9Q718, F9Q720, F9Q722, F9Q730, F9Q731, F9Q732, F9Q733, F9Q734, F9Q736, F9Q738, F9Q740, F9Q744, F9Q748, F9Q750, F9Q752, F9Q754, F9Q758, F9Q759, F9Q760, F9Q762, F9Q768, F9Q770, F9Q772, F9Q774, F9Q780, F9Q782, F9Q784, F9Q786, F9Q788, F9Q790, F9Q796, F9Q800, F9Q803, F9Q804, F9Q808, F9Q812, F9Q816, F9Q818, F9Q820, G8T714, G8T716, G8T740, G8T752, G8T760, G8T790, G8T792, G8T794, G9T600, G9T605, G9T700, G9T702, G9T703, G9T706, G9T707, G9T710, G9T712, G9T720, G9T722, G9T742, G9T743, G9T750, G9U720, G9U724, G9U726, G9U730, G9U750, G9U754, J5T, J6R, J7R, J7R732, J7R733, J7R734, J7R735, J7R768, J7T600, J7T760, J7T761, J7T762, J7T766, J7T772, J7T780, J7T782, J8S620, J8S621, J8S622, J8S758, J8S760, J8S776, J8S778, K4J700, K4J710, K4J711, K4J712, K4J713, K4J714, K4J715, K4J716, K4J717, K4J718, K4J719, K4J720, K4J724, K4J726, K4J730, K4J732, K4J734, K4J736, K4J740, K4J750, K4J770, K4J780, K4M700, K4M701, K4M704, K4M706, K4M707, K4M708, K4M709, K4M710, K4M711, K4M712, K4M714, K4M716, K4M718, K4M720, K4M724, K4M730, K4M732, K4M734, K4M736, K4M740, K4M742, K4M743, K4M744, K4M745, K4M746, K4M748, K4M750, K4M752, K4M753, K4M754, K4M760, K4M761, K4M762, K4M764, K4M765, K4M766, K4M768, K4M776, K4M782, K4M788, K4M790, K4M791, K4M794, K4M796, K4M800, K4M801, K4M802, K4M804, K4M812, K4M813, K4M830, K7M, K9K700, K9K702, K9K704, K9K706, K9K710, K9K712, K9K714, K9K716, K9K718, K9K722, K9K724, K9K728, K9K729, K9K732, K9K734, K9K740, K9K750, K9K752, K9K760, K9K762, K9K764, K9K766, K9K768, K9K802, K9K804, K9K806, N7Q704, N7Q710, N7Q711, N7U700, N7U701, S8U720, S8U722, S8U730, S8U731, S8U742, S8U748, S8U750, S8U752, S8U770, S8U772, S8U780, S8U782, S9U700, S9U702, S9U704, S9U714, S9U740, S9W206, S9W208, S9W212, S9W700, S9W702</p>

53770

221,00€

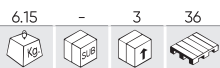

MÓDULO DE BLOQUEIO FORD/SEAT/
VOLKSWAGEN/MAZDA/VOLVO



MARCAS	<p>FORD: FIESTA, FUSION, COURIER, ESCORT, FOCUS, FOCUS C MAX, PUMA, MONDEO, SIERRA, COUGAR, GALAXY, C-MAX, ORION, TOURNEO CONNECT, TRANSIT CONNECT. MAZDA: I21 SEAT: ALHAMBRA VOLVO: S40, V50 VOLKSWAGEN: SHARAN</p>
FERRAMENTAS OEM	<p>U2003, 0132-AB, 0178-D, 0194-B, 0194-C, 2064, 21-104, 21-105, 21-123, 21-151, 21-162B, 21-163, 21-168, 21-210, 21-229, 21-234, 21-238, 21-251, 21-260, 21-262, 21-263, 23-019, 23-020, 23-047, 23-058, 23-059, 303-0985, 303-1054, 303-1059, 303-1061, 303-1151, 303-193, 303-367, 303-376, 303-393, 303-393-01, 303-620, 303-651, 303-652, 303-675, 303-679A, 303-689, 303-732, 303-734, 303-735, 303-748, 310-055, 310-084, 310-085, 323-029, 49 JE 02 020, 49 JE 02 021</p>
CÓDIGOS DE MOTOR	<p>ABFA, AFN, AHU, ANU, ASDA, ASDB, AUJ, AVG, AZBA, AZBC, AZWA, AZWC, BHPA, B4164S3, C9DC, DHA, DHB, DHC, DHD, DHE, DHF, DHG, DVTED4 (8HV), DVTED4 (9HZ), DV4TD, DV4TD (8HW), DV4TD (8HX), DV4TD (8HZ), DV4TED4, DV4TED4 (5HY), DV6ATED4 (9HX), DV6ATED4 (9HY), D2FA, D24, D24T, D24TIC, D3FA, D4FA, D5BA, D6BA, FFBA, FFWA, FHA, FHE, FIF, FMBA, FMBA/B, FUJA, FUJB, FXDA, FXDA/C, FXDB/D, FXFA, FXJA, FXJB, FXJC, FYDA, FYDB, FYDH, FYJA, FYJB, FYJC, F3FA, F4FA, F6JA, F6JB, F6JC, F6JD, F9DA/B, G6DA, G6DC, G6DD, G6DE, G6DF, G6DG, G8DA, G8DB, HCPB, HHDA, HHDB, HHJA, HHJC, HHJD, HHJE, HHJF, HJBA/B, HJWB, HWDATZ, HXDA, HXJA, HXJB, H9FA, H9FB, IQDA/8, IQDB, JQDA, JTDA, JTD, KHBA, KKDA, KKDB, KLBA, KLWA, KNBA, LPBA, LQDB, LIE, LIG, LJK, LIT, LIV, MZ-CD 1.6, M7JA, M7JB, N7BA, N7BB, PNBA, PNDA, P7PA, P9PA, P9PB, QJBA, QJBB, QJBD, QXBA, QXBB, QXWA, QXWB, QYBA, QYWA, Q4BA, RDA, RDB, RFK, RFN, RHBA, RKC, RKD, RQB, RQC, RTJ, RTK, RVA, RWPA, RWPC, R2PA, R3PA, SHDA, SHDB, SHDC, SIDA, SNJA, SNJB, SPJA, STJA, STJB, TXBA, TXDA, TXDB, TXWA, TYBA, TYDA, TYWA, TZJA, TZJB, UFBA, UFDA, UFDB, UFWA, UKBA, UKDA, UKDB, UKWA, UGCB, Y6, 1Z, 4BA, 4BB, 4BC, 4CC, 4DA, 4EA, 4EB, 4EC, 4ED, 4FA, 4FB, 4FC, 4FD, 4GA, 4GB, 4GC, 4GD, 4GE, 4GF, 4HA, 4HB, 4HC, 4HD</p>

53771

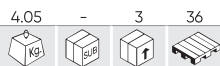

MÓDULO DE BLOQUEIO FIAT/FORD/CITROËN/PEUGEOT



MARCAS	<p>CITROËN: C15, C1, C2, C3 PLURIEL, C4, C4 PICASSO, C5, C6, C8, DS3, DS4, DS5, XANTIA, XSARA, XSARA PICASSO, EVASION, BERLINGO, JUMPY, JUMPER, SAXO, ZX, XM, EVASION, AX</p> <p>FIAT: ULYSSE, SCUDDO, DUCATO</p> <p>FORD: FIESTA, FUSION, FOCUS, FOCUS C-MAX</p> <p>LANCIA: ZETA, PHEDRA</p> <p>PEUGEOT: 107, 1007, 206 CC, 207, 208, 306, 307 CC, 308, 406, 407, 508, 607, 806, 607, 806, 807, PARTNER, EXPERT, BOXER, 206, 106, 605, 205, 405</p>
FERRAMENTAS OEM	<p>MOT 1436, 0117-AR, 0132-AB, 0132-AJ1, 0132-AK, 0132-X, 0134-AF, 0134-Q, 0153-AB, 0153-AK, 0153-G, 0153-M, 0153-N, 0153-U, 0153-4, 0178-C, 0178-D, 0178-E, 0188-AH, 0188-AK, 0188-D, 0188-E, 0188-F, 0188-J1, 0188-J2, 0188-M, 0188-P, 0188-Q1, 0188-Q2, 0188-X, 0188-Y, 0189-A, 0189-C, 0189-J, 0189-K, 0189-L, 0189-R, 0189-S1, 0189-S2, 0194-A, 0194-B, 0194-C, 0606-A1.A2, 174, 188-P2, 189-B, 21-163, 21-262, 303-734, 4200-TH, 4507-TJ, 4507-TL, 4527-TS1, 4527-TS2, 4533-TAC1, 4533-TAD, 5711TA, 6012-T, 7014-TJ, 7014-TM, 7015-T, 7017-TM, 7017-TR, 7019-T, 7099-TM, 9004-T, 9041-TZ, 9765-54, 9767-89, 9767-94, 9797-34</p>
CÓDIGOS DE MOTOR	<p>DV4TED4, DV6ATED4, DW10, DW12, DW8, ET3JE, EW10A, EW10-CVI, EW10D, EW10J4S, EW12, EW12J4, EW7 J4 (RLZ), EW7J4, F6JA, F6JB, F6JC, G8DB, HHDA, HHDB, HHJA, HHJB, TDCI, TU1 (HDY/HDZ/HFX/HFY/HFZ), TU3 (KDX/KDY/KDZ/KFX/KFZ), TU3A/J, TU5 (BDY/BFZ/NFT/NFV/NFW/NFY/NFZ), TU5JP4 (NFU/NFX), TU9 (CDY/CDZ, XU10, XU10JP4, XU7 JP4, XU7 (LFW/LFX/LFZ)</p>

53773

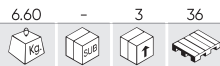

MODULO DE BLOQUEIO FIAT/ ALFA/LANCIA/OPEL/SUZUKI/FORD



MARCAS	<p>ALFA: ROMERO 145, 146, 147, 155, 156, 159, 166, SPIDER, GTV, TS, GT. CROSSWAGON Q4</p> <p>FIAT: PUNTO, GRANDE PUNTO, BRAVA, BRAVO, MAREA, WEEKEND, STILO, DOBLO, CARGO, IDEA, PANDA, MULTIPLA, PALIO, STILO, 500</p> <p>FORD: KA</p> <p>LANCIA: LYBRA, YPSILON, THESIS, MUSA</p> <p>OPEL: CORSA, AGILA, MERIVA, COMBO, VECTRA, ZARA, ASTRA, ISGNA SIGNUM 1.9 CDTI</p> <p>SUZUKI: IGNIS, SWIFT, WAGON R+</p>
FERRAMENTAS OEM	<p>EN-46788, 1860161000, 1860703000, 1860771000, 1860845000, 1860874000, 1860876000, 1860898000, 1860905000, 1860933000, 1860965000, 1860985000, 1860987000, 1860992000, 1870896900, 1870900300, 1870900400, 1871000900, 1895443000, 2000004200, 2000004300, 2000004400, 2190754200, 2190754400, 2190754500, 860863000</p>
CÓDIGOS DE MOTOR	<p>Z13DT, Z13DTH, Z13DTJ, Z19DT, Z19DTH, Z19DTJ, Z19DTL, Z19DTR, 1182A4.000, 169A1.000, 169A4.000, 176B9.000, 178B3.000, 182A6.000, 182B2.000, 182B4.000, 182B6.000, 182B9.000, 185A2.000, 185A6.000, 186A3.000, 186A4.000, 186A6.000, 186A8.000, 186A9.000, 188A2.000, 188A3.000, 188A4.000, 188A5.000, 188A7.000, 188A8.000, 188A9.000, 192A1.000, 192A3.000, 192A5.000, 192A8.000, 192A9.000, 192B1.000, 19284.000, 198A2.000, 198A3.000, 198A5.000, 198A6.000, 199A2.000, 199A3.000, 199A4.000, 199A5.000, 199A7.000, 199A9.000, 199B1.000, 199B2.000, 223A7.000, 2233A9.000, 323.02, 325.01, 342.02, 350A2.000, 350A3.000, 362.02, 371.01, 841C.000, 841G.000, 841H.000, 841P.000, 843A1.000, 937A2.000, 937A5.000, 939A1.000, 939A3.000, 939A5.000, 940A3.000, 940A4.000, 940A5.000, 955A3.000, 955A4.000</p>

53772

257,00€

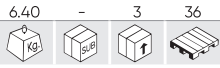

MÓDULO DE BLOQUEIO FORD/VAG/MAZDA/VOLVO



MARCAS	<p>AUDI: 80, A1, A2, A3, S3, A4, A5, A6, TT, Q5 FORD: GALAXY SEAT: AROSA, IBIZA, CORDOBA, LEON, TOLEDO, ALHAMBRA, ALTEA, INCA (99-04) SKODA: FABIA, OCTAVIA, SUPERB VOLKSWAGEN: LUPO, POLO, FOX, GOLF, BORA, JETTA, GOLF PLUS, PASSAT, BEETLE, TOURAN, SHARAN, CADDY, CADDY MAXI, TRANSPORTEDR, GOLF VI CARBO, TIGUAN</p>
FERRAMENTAS OEM	<p>MP1-1312, MP1-301, T00115 , T0015, T10008, T10016, T10020, T10050, T10060, T10060A, T10074, T10092, T10098, T10100, T10115, T10120, T10121, T10123, T10170, T10171, T10252, T10264, T10340, T10341, T10414, T20038, T20044, T20102, T30052, T30092, T30094, T40026, T40069, T40098, U20003, U30009A, U40021, VAS6079, 2064, 2065A, 23-058, 23-059, 2587, 303-1054, 310-084, 310-085, 3242, 3359, 3366, 3369, 3387, 3411, 3418, 3458</p>
CÓDIGOS DE MOTOR	<p>ACV, AFB, AFH, AFK, AFN, AGX, AHD, AHU, AHW, AHY, AJM, AJT, AJV, AKE, AKQ, AMF, AMG, ANJ, ANU, ANY, APA, APE, AQQ, ARC, ARL, ASZ, ATD, ATJ, ATL, ATN, AUA, AUB, AUF, AUS, AUY, AVB, AVF, AVQ, AVY, AWX, AWY, AXB, AXC, AXG, AXL, AXP, AXR, AXU, AYC, AYM, AYY, AYZ, AZD, AZQ, AZV, BAG, BAY, BBE, BBF, BBY, BBZ, BCA, BCB, BCZ, BDG, BDH, BDJ, BDK, BE, BEW, BFG, BFV, BGW, BHC, BHP, BHW, BJB, BJJ, BJK, BJL, BJM, BKC, BKD, BKE, BKF, BKG, BKP, BLB, BLF, BLN, BLP, BLS, BLT, BMA, BMB, BMM, BMN, BMP, BMR, BMS, BMT, BMW, BMY, BNA, BNM, BNU, BNV, BPW, BPX, BRB, BRC, BRE, BRF, BRM, BRR, BRS, BRT, BRU, BSS, BSU, BSW, BTB, BTS, BUK, BUY, BUZ, BVA, BVE, BVF, BVG, BVH, BVK, BVP, BVR, BWK, BWV, BXE, BXF, CAGA, CAGB, CAGC, CAHA, CAXA, CAYA, CAYB, CAYC, CBAA, CBAB, CBAC, CBBA, CBBB, CBDA, CBDB, CBEA, CBZA, CBZB, CBZC, CEGA, CKUB, RKD, 1Z</p>

53774

208,00€

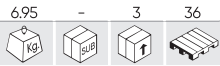

MÓDULO DE BLOQUEIO OPEL/CHEVROLET/SAAB/FIAT/LANCIA/SUZUKI/FORD



MARCAS	<p>ALFA: 145, 146, 147, 156, 159, 166, GT, CROSSWAGON Q4 CHEVROLET & DAEWOO: EPICA, CAPTIVA, NUBITA, LACETTI, EVANDA FIAT: PUNTO, GRANDE PUNTO, BRAVO, BRAVAM MAREA, WEEKEND, STILO, DOBLÒ, CARGO, MULTIPLA IDEA, PANDA FORD: KA LANCIA: YPSILON, MUSA, LYBRA, THESIS OPEL: CORSA B/C, COMBO, TIGRA, AGILA, TIGRA B, MERIVA, ASTRA F/G/H, ASTRAVAN, SPEEDSTER VX220, ZAFIRA A/B, VECTRA B/C, SIGNUM, OMEGA B, SINTRA, FRONTERA A/B, ASTRAVAN, KADETT, ASCONA, OMEGA, MONTERY, ANTARA, CROMA, SPEEDSTER, VX220 SAAB: 9-3, 9-5 (98-04) SUZUKI: IGNIS, SWIFT, WAGON R+</p>
FERRAMENTAS OEM	<p>EN-46781, EN-46785, EN-46788, EN-46789, EN-48245, EN-48246, KM-J-43651, KM-6130, KM-6148, KM-6349, KM-852, KM-853, KM-927, KM-929, KM-932, KM-933, KM-951, KM-952, KM-954, KM-955, 1860703000, 1860905000, 1860905010, 1860985000, 1870896900, 1870900300, 1870900400, 1871000200, 1871000900, 21-162B, 303-1468, 303-376, 303-376B</p>
CÓDIGOS DE MOTOR	<p>182B4.000, 182B9.000, 186A6.000, 186A8.000, 188A2.000, 188A3.000, 188A7.000, 188A8.000, 188A9.000, 188B2.000, 192A1.000, 192A9.000, 199A2.000, 199A3.000, 199A9.000, 199B1.000, 199B2.000, 323.02, 371.01, 937A2.000, 939A2.000, 940A3.000, C18XEL, C20SEL, C20XE, D223L, JG2T, RA420, X12XE, X14XE, X16SEJ, X16SZR, X16XE, X16XEL, X17DT, X17DTL, X18XE, X18XE1, X20DTH, X20DTL, X20XEV, X22DTH, X22SE, X22XE, Y16XE, Y17DT, Y17DTI, Y17DTL, Y20DTH, Y20DTL, Y22DTH, Y22DTR, Y22SE, Y22XE, Z10XE, Z10XEP, Z12XE, Z13DT, Z13DTH, Z13DTJ, Z14XE, Z14XEP, Z16SE, Z16XE, Z16YNG, Z18XE, Z18XEL, Z19DT, Z19DTH, Z19DTJ, Z19DTL, Z20DM, Z20DMH, Z20LEH, Z20LEL, Z20LER, Z20LET, Z20S1, Z22SE, Z22XE, Z22YH, 16DA, 169A1.000, 17D, 17DR/X, 185A2.000, 185A6.000, 186A9.000, 192A3.000, 192A5.000, 192A8.000, 192B1.000, 192B4.000, 194A1.000, 198A2.000, 198A3.000, 198A6.000, 199A5.000, 223A7.000, 223A9.000, 342.02, 350A2.000, 350A3.000, 362.02, 4EC1, 4EC1/T, 4EE1, 4EE1/T, 4FC1/T, 4FD1, 4JX1/4, 7DTL, 841G.000, 841H.000, 841P.000, 939A1.000, 939A3.000, 955A3.000, 955A4.000</p>

CARROS DE FERRAMENTAS COM 7 GAVETAS

ESPECIAL KIT DE BLOQUEIO

REF.	GAVETAS	COR	EQUIPADO	PEÇAS	MATERIAL					€
53951	7		Com ferramentas	250	Aço	94.70	-	1	4	1.794,00€
53952	7		Com ferramentas	250	Aço	94.70	-	1	4	1.794,00€
54501	7		Com ferramentas	250	Aço	94.70	-	1	4	1.794,00€
54502	7		Com ferramentas	250	Aço	94.70	-	1	4	1.794,00€



CONTÉM

53775

1.378,00€

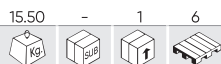

MÓDULO DE 6 FERRAMENTAS DE SINCRONIZAÇÃO DE MOTOR

53769

195,00€

53770

221,00€

53771

158,00€



53772

257,00€

53773

327,00€

53774

208,00€



ACESSÓRIOS DE LUBRIFICAÇÃO

BOMBAS DE ABASTECIMENTO DIESEL	354	BALDES DE COLEÇÃO DE ÓLEO	360
BOMBAS DE ABASTECIMENTO DE UREIA	355	PISTOLAS DE SUCÇÃO	361
BOMBAS DE ENCHIMENTO/EXTRAÇÃO	356	OUTROS	362
COLETORES DE ÓLEO	358		



53697

398,00€

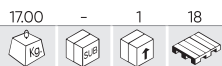

BOMBA DE COMBUSTÍVEL DIESEL COM DOSADOR E INDICADOR (200-240V)

Tensão	220-240V
Potência	550W
Taxa de entrega	20-65L/min
Comprimento do cabo	2m
Comprimento da mangueira de aspiração	2m
Comprimento da mangueira de alimentação	4m
Tipo	Paro automático/Automatic stop
Peso	17,00Kg



REPOSIÇÕES DISPONÍVEIS



53610

294,00€



BOMBA DISPENSADORA DE DIESEL COM PISTOLA (230V)

REPOSIÇÕES DISPONÍVEIS

Tensão	230V
Potência	550W
Taxa de entrega	60L/min
Altura máxima de sucção	3m
Comprimento da mangueira de aspiração	2m
Comprimento da mangueira de alimentação	4m
Tipo	Paro automático/Automatic stop
Peso	13,00Kg



53609

182,50€



BOMBA DE ABASTECIMENTO DE DIESEL COM PISTOLA (12V)

REPOSIÇÕES DISPONÍVEIS

Tensão	12V
Potência	175W
Taxa de entrega	45L/min
Altura máxima de sucção	3m
Comprimento da mangueira de aspiração	2m
Comprimento da mangueira de alimentação	4m
Tipo	Paro automático/Automatic stop
Peso	7,30Kg



54100

265,00€

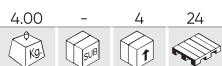

BOMBA DIESEL ELÉTRICA 205L

Medição de voltagem em corrente alternada (AC)	12V
Medição de voltagem em corrente contínua (DC)	100-240V
Taxa de entrega	18,4L/min
Comprimento do cabo	4m
Comprimento da mangueira de aspiração	850-1245mm
Comprimento da mangueira de alimentação	2m
Tipo	Diesel
Peso	4,00Kg



53645

268,00€



BOMBA ELÉTRICA PARA UREA AUS32 205L

Medição de voltagem em corrente alternada (AC)	12V
Medição de voltagem em corrente contínua (DC)	100-240V
Taxa de entrega	18,4L/min
Comprimento do cabo	2m
Comprimento da mangueira de aspiração	850-1245mm
Comprimento da mangueira de alimentação	2m
Tipo	Adblue
Peso	3,10Kg



REPOSIÇÕES DISPONÍVEIS



53644

1.238,00€

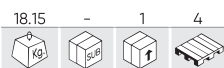

TANQUE DE UREA AUS32 75L



Capacidade	75L
Tensão	12V
Taxa de entrega	10L/min
Pressão do trabalho	2,75BAR (40PSI)
Comprimento do cabo	4m
Comprimento da mangueira de alimentação	4m
Tipo	Adblue
Peso	18,15Kg

52329

36,40€

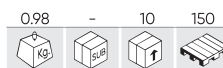

BOMBA MANUAL PLÁSTICA DE EXTRAÇÃO



Taxa de entrega	350ml (15L/min)
Comprimento da mangueira de aspiração	320-900mm
Compatível com	Bidones/Canisters 25L, 50L, 200L
Viscosidade	200mPas
Material	PP
Peso	0,98Kg

15631

98,00€

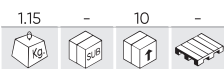

PISTOLA AUTOMÁTICA PARA UREA AUS 32 (POS. NO. 53645)



Entrada de fluido	19mm
Saída de fluido	15mm
Taxa de fluxo máxima	35L/min
Tipo	Adblue
Compatível com	53645
Peso	1,15Kg

13982

4,00€

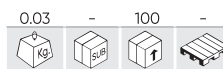

ADAPTADOR DE ROSCA DE TAMBORES PLÁSTICOS



Medida da rosca fêmea	570mm
Medida da rosca macho	555mm
Tipo	Adblue
Peso	0,05Kg
Dimensões (CxLxA)	72x52x52mm

54514

109,00€

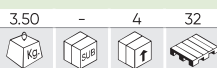

BOMBA PNEUMÁTICA/MANUAL PARA EXTRAÇÃO DE ÓLEO 6.5L

Capacidade	6,5L
Pressão do trabalho	2,76-11,72BAR
Entrada de ar	1/4"
Temperatura de trabalho	2/80°C
Peso	3,15Kg
Dimensões (CxLxA)	225x215x565mm



54555

149,00€



BOMBA DE TRANSMISSÃO PNEUMÁTICA 10L

Capacidade	10L
Pressão do trabalho	2,8-11,7BAR
Entrada de ar	1/4"
Temperatura de trabalho	-3/140°C
Peso	4,00Kg
Dimensões (CxLxA)	280x245x530mm



52797

198,00€

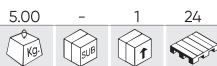

BOMBA MANUAL PARA SISTEMAS DE TRANSMISSÕES 7.5L

Capacidade	7,5L
Descarga	80cc
Viscosidade	140SAE
Contém	15 Adaptadores/Adapters
Peso	5,00Kg
Dimensões (CxLxA)	270x270x480mm



REPOSIÇÕES DISPONÍVEIS



53566

32,00€

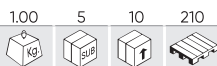

BOMBA DE ASPIRAÇÃO DE ÓLEO - 12V

Tensão	12V
Consumo de energia	5A
Intensidade do som	70dB
Nível de fluidiz (Diesel)	2L/min
Nível de fluidiz (Óleo de motor)	1L/min
Medidas do tubo de aspiração	1,2m
Medidas do tubo de expiração	1,5m
Acionamento pneumático	1,00Kg



1,2m
Ø 6mm
1,5m
Ø 12mm

53627

22,50€

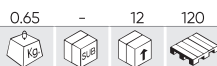

KIT DE EXTRAÇÃO DE ÓLEO E COMBUSTÍVEL 1.6L

Capacidade	1,6L
Comprimento da mangueira	1-1,3m
Peso	0,65Kg
Dimensões (CxLxA)	530x380x490mm



52601 397,00€



BOMBA PARA TAMBOR DE ÓLEO + MANGUEIRA COM TORNEIRA



REPOSIÇÕES DISPONÍVEIS



Taxa de compressão	5:1
Entrada de ar	1/4"
Saída de ar	1/2"
Pressão do trabalho	6-8BAR
Capacidade relativa	18L/min
Consumo real de ar	250L/min
Temperatura do óleo	-10/50°C
Viscosidade	240SAE
Comprimento do tubo	950mm
Comprimento da mangueira	4m
Peso	9,10Kg

50918 341,00€

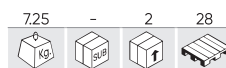

BOMBA PARA TAMBOR DE ÓLEO



REPOSIÇÕES DISPONÍVEIS



Taxa de compressão	5:1
Entrada de ar	1/4"
Saída de ar	1/2"
Pressão do trabalho	6-8BAR
Capacidade relativa	18L/min
Consumo real de ar	250L/min
Temperatura do óleo	-10/50°C
Viscosidade	240SAE
Comprimento do tubo	950mm
Peso	7,25Kg

50935 595,00€

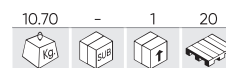

KIT BOMBA ÓLEO PARA TAMBOR DE ÓLEO+MANGUEIRA+PISTOLA ÓLEO DIGITAL



Taxa de compressão	5:1
Entrada de ar	1/4"
Saída de ar	1/2"
Pressão do trabalho	6-8BAR
Capacidade relativa	18L/min
Consumo real de ar	250L/min
Temperatura do óleo	-10/50°C
Viscosidade	240SAE
Comprimento do tubo	950mm
Comprimento da mangueira	2m
Peso	10,70Kg

50917 271,00€

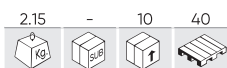

PISTOLA DE BOMBEAMENTO DE ÓLEO COM CAUDALÍMETRO DIGITAL



REPOSIÇÕES DISPONÍVEIS



Entrada de fluido	1/2"
Consumo real de ar	1-35L/min
Pressão do trabalho	6-8BAR
Pressão máxima	100BAR
Viscosidade	240SAE
Precisão do medidor de vazão	±0,5%
Repetibilidade do medidor de vazão	0,2%
Velocidade de descarga por revolução	25ml/R
Bateria	Pilas/Batteries
Peso	2,15Kg
Dimensões (CxLxA)	500x90x160mm

52428 40,00€

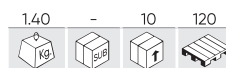

BOMBA MANUAL PARA EXTRAÇÃO



Consumo real de ar	32L/min
Saída de fluido	Ø25mm
Entrada de fluido	Ø32mm
Comprimento do tubo	1016mm
Peso	1,40Kg

51253 41,00€

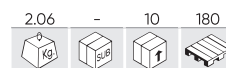

BOMBA DE ÓLEO MANUAL



Fluxo de trabalho	300ml
Entrada de fluido	Ø22,60mm
Saída de fluido	Ø16mm
Comprimento do tubo	890mm
Diâmetro de descarga	19mm
Diâmetro de sucção	35mm
Peso	2,06Kg
Dimensões (CxX)	465x1400mm

53874

398,00€



COLETOR DE ÓLEO COM SISTEMA DE ASPIRAÇÃO 90 LITROS TANQUE

Pressão do trabalho	8-10BAR
Capacidade do tanque	70L
Capacidade do coletor de peneiras	10L
Capacidade do copo medidor	10L
Peso	22,00Kg
Dimensões (CxLxA)	430x490x1470mm



REPOSIÇÕES DISPONÍVEIS



VÍDEO TUTORIAL



53873

285,00€

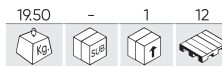

COLETOR DE ÓLEO COM 80 LITROS TANQUE

Pressão do trabalho	1-3BAR
Capacidade do tanque	70L
Capacidade do coletor de peneiras	10L
Peso	18,00Kg
Dimensões (CxLxA)	350x480x1630mm



REPOSIÇÕES DISPONÍVEIS



50924

342,00€

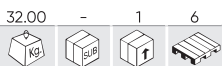

CARRO PORTA BIDÕES 200KG

Capacidade	200Kg
Material	Fe
Peso	31,00Kg
Dimensões (CxLxA)	990x790x830mm



15084

68,00€

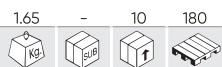

MÓDULO DE EXTRAÇÃO DE TAMPÕES DE CÁRTER

	x2	5/16", 3/8"		x1	T45
	x7	7, 8, 10, 11, 12, 13, 14mm		x1	M16
	x1	10mm		x1	200mm
	x1	10mm		x1	150mm
	x7	8, 9, 10, 12, 13, 14, 17mm			



54050

895,00€

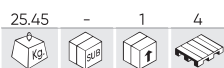

MÁQUINA DE TROCA DE ÓLEO DE TRANSMISSÃO AUTOMÁTICA

Tensão	12V
Potência	70W
Pressão do trabalho	0-10BAR (0-150PSI)
Capacidade do tanque de óleo novo	30L
Capacidade do depósito de óleo usado	30L
Peso	25,46Kg
Dimensões (CxLxA)	270x500x860mm



REPOSIÇÕES DISPONÍVEIS



VÍDEO TUTORIAL



54290

4.307,00€

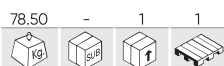

MÁQUINA DE TROCA DE ÓLEO DE TRANSMISSÃO AUTOMÁTICA

Tensão	220V
Potência	150W
Intensidade	50Hz
Velocidade de troca	2L/min
Faixa de trabalho	0-105PSI
Capacidade de óleo novo	20L
Capacidade de óleo usado	20L
Precisão do filtro	5µm
Comprimento da mangueira de saída	2,5m
Comprimento da mangueira de retorno	2,5m
Comprimento do tubo de drenagem	1,2m
Intensidade do som	<70dB
Temperatura de trabalho	-10/50°C
Peso	78,50Kg
Dimensões (CxLxA)	710x580x1040mm



REPOSIÇÕES DISPONÍVEIS



VÍDEO TUTORIAL



54367

729,00€

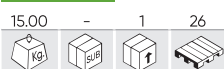

KIT DE ADAPTADORES PARA REF. 54290 (105 PÇS)



INFORMAÇÕES TÉCNICAS



52804

343,00€

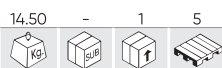

TANQUE DE ARMAZENAMENTO DE TAMBOR - 1 TAMBOR VERTICAL 400KG

Capacidade	400Kg
Capacidade de carga dos tambores	230L
Liczba barył	1
Material	PE
Peso	14,50Kg
Dimensões (CxLxA)	1000x680x600mm



52805

426,00€

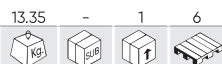

TANQUE DE ARMAZENAMENTO DE TAMBORES - 2 TAMBORES VERTICAIS 650KG

Capacidade	650Kg
Capacidade de carga dos tambores	250L
Liczba barył	2
Material	PE
Peso	31,35Kg
Dimensões (CxLxA)	1300x750x440mm



52806

742,00€

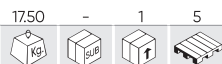

TANQUE DE ARMAZENAMENTO DE TAMBOR - 4 TAMBORES VERTICAIS 1250KG

Capacidade	1250Kg
Capacidade de carga dos tambores	250L
Liczba barył	4
Material	PE
Peso	17,50Kg
Dimensões (CxLxA)	1290x1290x280mm

* Não adequado para porta paletes



53214

285,00€

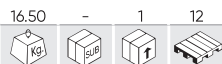

TANQUE DE ARMAZENAMENTO DE TAMBOR ESPECIAL EUROPALETE 2 BIDÕES 650KG

Capacidade	650Kg
Capacidade de carga dos tambores	230L
Liczba barył	2
Material	PE
Peso	17,00Kg
Dimensões (CxLxA)	1310x910x380mm



54498

6.090,00€

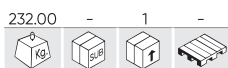

CAPA DURA DO IBC 2500KG

Capacidade	2500Kg
Capacidade dos contentores de 1000 litros	1
Capacidade dos tambores de 200 litros	4
Material	PE
Normas	DIBT
Peso	232,00Kg
Dimensões (CxLxA)	1775x1770x2500mm

* Contentor IBC não incluído



52807

1.714,00€



TANQUE DE ARMAZENAMENTO - CONTAINER IBC 2500KG

Capacidade	2500Kg
Capacidade de carga dos contêineres	1000L
Número de contêineres	1
Material	PE
Peso	30,00Kg
Dimensões (CxLxA)	1680x1680x700mm



53612

96,00€



BRAÇADEIRA PARA TAMBORES 500KG

Capacidade	500Kg
Material	S
Peso	4,75Kg
Dimensões (CxLxA)	745x99x148mm



52498

58,00€

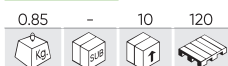

SERINGA TRANSPARENTE 1500ML



Capacidade	1500ml
Material	PP
Comprimento do tubo	483mm
Comprimento da pistola	500mm
Peso	0,85Kg

52628

26,50€



SERINGA TRANSPARENTE 200ML



Capacidade	200ml
Material	PP
Comprimento do tubo	360mm
Comprimento da pistola	570mm
Peso	0,25Kg

52789

15,20€

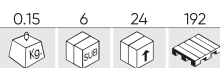

BOMBA MANUAL EXTRAÇÃO GASOIL



Comprimento da mangueira de alimentação	900mm
Comprimento da mangueira de aspiração	900mm
Material	0,15Kg
Peso	PVC

51928

14,00€

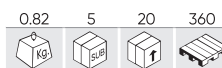

SERINGA DE SUÇÃO DE ÓLEO 0,5L



Capacidade	0,5L
Material	Cromado/Chrome Finish
Comprimento do tubo	275mm
Comprimento da pistola	340mm
Peso	0,83Kg

53215

19,00€



RECOLHEDOR DE ANTICONGELANTE. 18L



Cor	Verde/Green
Capacidade	18L
Material	PE
Peso	0,95Kg
Dimensões (CxLxA)	550x460x180mm

53144

18,00€



RECOLHEDOR DE ÓLEO 18L



Cor	Negro/Black
Capacidade	18L
Material	PE
Peso	0,99Kg
Dimensões (CxLxA)	550x460x180mm

54051

39,00€

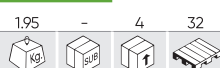

BANDEJA DE TROCA DE ÓLEO 8 L



Capacidade	8L
Material	PE
Peso	1,95Kg
Dimensões (CxLxA)	600x330x110mm

51356

48,00€



BANDEJA DE AÇO PARA LÍQUIDOS 23L



Capacidade	23L
Material	S
Peso	3,00Kg
Dimensões (CxLxA)	400x600x110mm

54558

11,50€



BANDEJA DE ÓLEO PARA CAMIÕES E REBOQUES



BIDÃO DE METAL PARA COMBUSTÍVEL

REF.	L	mm	MATERIAL					€
54181	5L	241x115x311mm	Aço	1.45	-	4	72	27,50€
54182	10L	284x133x386mm	Aço	2.55	-	4	48	38,50€
54183	10L	240x140x355mm	Aço	2.75	-	6	48	42,00€
54184	20L	356x166x460mm	Aço	4.10	-	4	24	44,00€

54181



REPOSIÇÕES
DISPONÍVEIS



54182



REPOSIÇÕES
DISPONÍVEIS



54183



REPOSIÇÕES
DISPONÍVEIS







54184



REPOSIÇÕES
DISPONÍVEIS



ACESSÓRIOS

REF.						€
52452	CHAVE PLÁSTICA PARA BIDÕES	0.12	6	60	1080	8,00€
53078	TORNEIRA PARA BIDÃO DE 200L	0.25	5	25	300	22,00€
53518	TORNEIRA DE PLÁSTICO DE 3/4" PARA BIDÃO DE ÓLEO	0.05	10	500	3000	3,50€
52453	TORNEIRA DE 3/4" PARA BIDÃO DE ÓLEO DE 200L	0.19	20	100	1000	25,00€



52452



53078



53518



52453

52991

10,50€



JARRO COM PESCOÇO FLEXÍVEL 2L



Capacidade	2L
Material	PP, PE
Peso	0,16Kg

52992

22,50€



JARRO COM PESCOÇO FLEXÍVEL 5L



Capacidade	5L
Material	PP, PE
Peso	0,30Kg



52242

12,00€

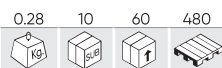

GALHETAS DE ÓLEO 500ML



Capacidade	500ml
Comprimento do tubo	160mm
Peso	0,28Kg

52243

8,50€

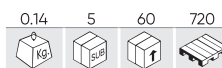

GALHETAS DE ÓLEO 250ML



Capacidade	250ml
Comprimento do tubo	125mm
Peso	0,14Kg

53187

39,00€

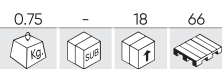

FUNIL PARA BIDÃO DE 200L COM TAMPA E FILTRO



Diâmetro	260mm
Material	PP
Peso	0,75Kg

53188

7,00€

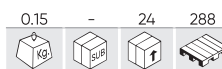

JOGO DE 3 FUNILS



Diâmetro	90, 130, 180mm
Material	PP
Peso	0,15Kg

52391

5,00€

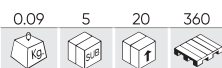

FUNIL COM FILTRO



Material	PP
Dimensões do tubo	250x100mm
Dimensões do funil	140x175mm
Peso	0,09Kg

54719

16,50€



FUNIL DE ÓLEO COM SUPORTE



Diâmetro	125mm
Material	PVC
Peso	0,37Kg
Dimensões (CxLxA)	300x130x220mm

53198 9,50€



FUNIL COM TUBO FLEXÍVEL



Material	PP
Dimensões do tubo	530mm
Dimensões do funil	180mm
Peso	0,15Kg

53849 16,10€



PISTOLA DE LUBRIFICAÇÃO COMPACTA



Capacidade	80cc
Pressão do trabalho	1000PSI
Material	S
Diâmetro	3,8mm
Peso	0,30Kg

54677 9,90€

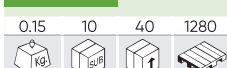

FERRAMENTA DE LIMPEZA DO BOCAL DE LUBRIFICAÇÃO



Peças	5
Material	PA
Comprimento	250mm
Peso	0,15Kg
Dimensões (CxLxA)	300x85x20mm

54255 68,00€



CONJUNTO COMPLETO DE ACESSÓRIOS PISTOLA DE LUBRIFICAÇÃO



Peças	7
Extensão de mangueira	300mm
Adaptadores	90-360°
Peso	1,60Kg
Dimensões (CxLxA)	260x170x60mm

50852 24,50€

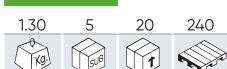

PISTOLA GRAXEIRA MANUAL COM TUBO FLEXÍVEL



Capacidade	500ml
Pressão do trabalho	20Mpa
Diâmetro interior	5mm
Diâmetro exterior	14mm
Peso	1,30Kg

50751 43,00€



BOMBA DE MASSA PNEUMÁTICA



Entrada de ar	1/4"
Capacidade	500ml
Pressão do trabalho	6,2BAR
Pressão máxima	30Mpa
Peso	1,50Kg

53592 25,00€

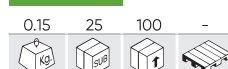

ACOPLADOR DE LUBRIFICAÇÃO DE LIBERAÇÃO RÁPIDA



Entrada de ar	1/8"
Pressão do trabalho	1034BAR
Compatível com	50751, 50852
Peso	0,15Kg



60038

255,00€



PISTOLA DE GRAXA PNEUMÉTICA ELLÉTRICA

Tensão	20V
Pressão máxima	620BAR
Volume/vazão	200g/min
Capacidade do cartucho	420g
Capacidade de graxa a granel	600g
Capacidade de graxa a granel	NLGI#2
Comprimento	760mm
Modos de carregamento	Granel/Bulk, Cartucho/Cartridge, Succión/Suction
Compatível com	60012, 60013, 60015, 60016, 60017
Peso	3,60Kg
Dimensões (CxLxA)	400x90x270mm



REPOSIÇÕES DISPONÍVEIS

60038C

411,00€



PISTOLA DE GRAXA PNEUMÉTICA ELLÉTRICA COM MALETA

Tensão	20V
Pressão máxima	620BAR
Volume/vazão	200g/min
Capacidade do cartucho	420g
Capacidade de graxa a granel	600g
Capacidade de graxa a granel	NLGI #2
Comprimento	760mm
Modos de carregamento	Granel/Bulk, Cartucho/Cartridge, Succión/Suction
Inclui	60038, 60013, 60016
Compatível com	60012, 60013, 60015, 60016, 60017
Peso	3,60Kg
Dimensões (CxLxA)	400x90x270mm



REPOSIÇÕES DISPONÍVEIS



PÁGINA 138

PILHAS E CARREGADORES NÃO INCLUÍDOS NAS FERRAMENTAS INDIVIDUALES

Três tipos de bateria e dois tipos de carregador. Escolha o que você preferir!



FERRAMENTAS HIDRÁULICAS

MACACOS HIDRAULICOS DE RODAS

MACACOS DE MANIVELA

MACACOS TIPO GARRAFA

MACACO HIDRÁULICO TELESCÓPICO

CAVALETES

OUTROS

368 PORTA PALETES MANUAL

370 PRENSAS

371 GUINDASTES

372 MESAS DE ELEVAÇÃO

372 BASES SE ELEVAÇÃO

373

374

375

376

377

379



53725

248,00€

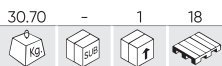

MACACO HIDRÁULICO DE RODAS 3T - SISTEMA RÁPIDO



REPOSIÇÕES DISPONÍVEIS



Capacidade	3T
Altura mínima	133mm
Altura máxima	465mm
Ajuste de altura	Rápida/Fast
Conformidade com a diretiva europeia	EN 1494:2001+A1
Peso	32,00Kg
Dimensões (CxLxA)	682x155x344mm

50818

198,00€

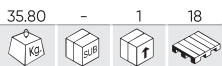

MACACO HIDRÁULICO COM RODAS 3,5T



REPOSIÇÕES DISPONÍVEIS



Capacidade	3,5T
Altura mínima	133mm
Altura máxima	495mm
Conformidade com a diretiva europeia	EN 1494:2001
Peso	35,80Kg
Dimensões (CxLxA)	685x180x346mm

53422

368,00€

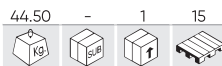

MACACO HIDRÁULICO 3T COM ALAVANCA DE ELEVÇÃO



REPOSIÇÕES DISPONÍVEIS



Capacidade	3T
Altura mínima	100mm
Altura máxima	533mm
Conformidade com a diretiva europeia	EN1494:2000+A1
Peso	44,50Kg
Dimensões (CxLxA)	778x165x372mm

53112

298,00€

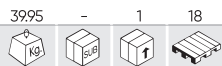

MACACO HIDRÁULICO COM PEDAL



REPOSIÇÕES DISPONÍVEIS



Capacidade	3T
Altura mínima	140mm
Altura máxima	520mm
Conformidade com a diretiva europeia	EN1494:2000+A1
Peso	39,95Kg
Dimensões (CxLxA)	720x185x345mm

50815

88,00€

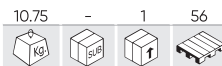

MACACO HIDRÁULICO DE RODAS 2T



REPOSIÇÕES DISPONÍVEIS



Capacidade	2T
Altura mínima	130mm
Altura máxima	355mm
Conformidade com a diretiva europeia	EN1494:2000+A1
Peso	10,75Kg
Dimensões (CxLxA)	490x140x205mm

53968 49,00€

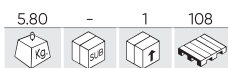

MACACO HIDRÁULICO COM RODAS 2T



REPOSIÇÕES DISPONÍVEIS



Capacidade	2T
Altura mínima	130mm
Altura máxima	355mm
Conformidade com a diretiva europeia	EN 1494:2001
Peso	5,80Kg
Dimensões (CxLxA)	490x140x205mm

51895 99,00€

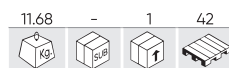

MACACO HIDRÁULICO COM RODAS 2T EM CAIXA PLÁSTICA



REPOSIÇÕES DISPONÍVEIS



Capacidade	2T
Altura mínima	130mm
Altura máxima	355mm
Conformidade com a diretiva europeia	EN1494
Peso	11,68Kg
Dimensões (CxLxA)	490x140x205mm

50816 88,00€



MACACO HIDRÁULICO DE RODAS 2T ESPECIAL CARROS BAIXOS



REPOSIÇÕES DISPONÍVEIS



Capacidade	2T
Altura mínima	85mm
Altura máxima	330mm
Conformidade com a diretiva europeia	EN1494+A1
Peso	11,25Kg
Dimensões (CxLxA)	508x125x208mm

53421 298,00€



MACACO HIDRÁULICO DE RODAS 2T ESPECIAL CARROS BAIXOS



REPOSIÇÕES DISPONÍVEIS



Capacidade	2T
Altura mínima	75mm
Altura máxima	505mm
Conformidade com a diretiva europeia	EN1494
Peso	33,50Kg
Dimensões (CxLxA)	740x150x360mm

54137 288,00€

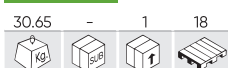

MACACO HIDRÁULICO DE RODAS 2,5T ESPECIAL CARROS BAIXOS



REPOSIÇÕES DISPONÍVEIS



Capacidade	2,5T
Altura mínima	78mm
Altura máxima	505mm
Conformidade com a diretiva europeia	EN1494:2000+A1
Peso	30,65Kg
Dimensões (CxLxA)	740x150x350mm

TUTORIAL DE MANUTENÇÃO
 CONSELHOS BÁSICOS PARA A MANUTENÇÃO CORRETA DOS NOSSOS MACACOS PARA PROLONGAR A SUA VIDA ÚTIL E SEGURANÇA



54516

861,00€

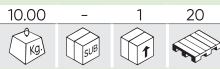

MACACO JACARÉ OLEO-PNEUMÁTICO TELESCÓPICO PARA 20/40T



REPOSIÇÕES DISPONÍVEIS

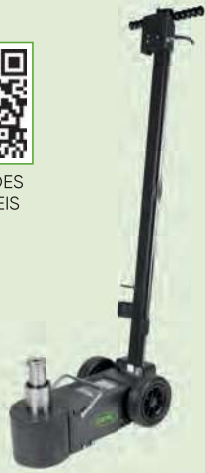

Capacidade	20/40T
Altura mínima	150mm
Altura máxima	227-295mm
Conformidade com a diretiva europeia	ENISO12100, EN1494
Adaptadores	41,50Kg
Entrada de ar	1/4"
Pressão do trabalho	7-10BAR
Consumo real de ar	9,5CFM
Peso	41,50Kg
Dimensões (CxLxA)	900x290x1195mm

54517

1.184,00€

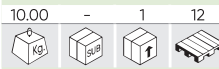

MACACO JACARÉ OLEO-PNEUMÁTICO TELESCÓPICO PARA 15/20/40T



REPOSIÇÕES DISPONÍVEIS



Capacidade	15/25/40T
Altura mínima	125mm
Altura máxima	185-240-301mm
Conformidade com a diretiva europeia	ENISO12100, EN1494
Adaptadores	35-65mm
Entrada de ar	1/4"
Pressão do trabalho	7-10BAR
Consumo real de ar	9,5CFM
Peso	38,70Kg
Dimensões (CxLxA)	918x285x1195mm

54751

617,00€



MACACO OLEO-PNEUMÁTICO EMPILHADOR DE 22 TONELADAS



REPOSIÇÕES DISPONÍVEIS



Capacidade	22T
Altura mínima	228mm
Altura máxima	548mm
Adaptadores	20-60-90mm
Entrada de ar	1/4"
Pressão do trabalho	7-10BAR
Consumo real de ar	9,5CFM
Extensível	110mm
Peso	43,00Kg
Dimensões (CxLxA)	1390x575x322mm

JACK ELEVADOR 3T

53895

117,00€

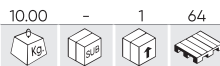

REPOSIÇÕES DISPONÍVEIS



Capacidade	3T
Altura mínima	130mm
Altura máxima	510mm
Peso	9,15Kg
Dimensões (CxLxA)	510x265x140mm

53896

127,00€



REPOSIÇÕES DISPONÍVEIS

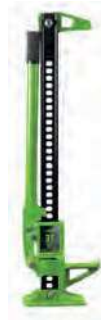

Capacidade	3T
Altura mínima	130mm
Altura máxima	645mm
Peso	11,60Kg
Dimensões (CxLxA)	840x265x140mm

53897

140,00€

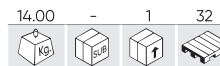

REPOSIÇÕES DISPONÍVEIS



Capacidade	3T
Altura mínima	130mm
Altura máxima	1045mm
Peso	13,85Kg
Dimensões (CxLxA)	1220x265x140mm

53898

148,00€

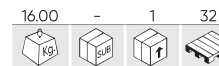

REPOSIÇÕES DISPONÍVEIS

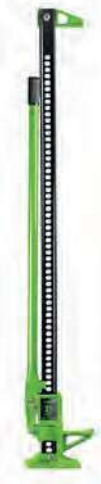

Capacidade	3T
Altura mínima	130mm
Altura máxima	1320mm
Peso	15,65Kg
Dimensões (CxLxA)	1520x265x140mm

MACACO TIPO GARRAFA

50819 28,00€

2,42 - 6 300



Capacidade	2T
Altura mínima	181mm
Altura máxima	345mm
Peso	2,43Kg
Dimensões (CxLxA)	95x110x190mm

50820 34,50€

3,20 - 6 300



Capacidade	3T
Altura mínima	194mm
Altura máxima	371mm
Peso	3,20Kg
Dimensões (CxLxA)	105x110x210mm

50821 47,00€

4,10 - 5 250



Capacidade	5T
Altura mínima	216mm
Altura máxima	413mm
Peso	4,10Kg
Dimensões (CxLxA)	120x115x230mm

50822 59,00€

5,60 - 4 200



Capacidade	10T
Altura mínima	230mm
Altura máxima	460mm
Peso	5,60Kg
Dimensões (CxLxA)	135x135x240mm

52304 84,00€

7,20 - 2 136



Capacidade	15T
Altura mínima	125mm
Altura máxima	365mm
Peso	7,20Kg
Dimensões (CxLxA)	140x140x250mm

50823 94,00€

9,75 - 2 96



Capacidade	20T
Altura mínima	242mm
Altura máxima	452mm
Peso	10,18Kg
Dimensões (CxLxA)	175x165x250mm

50824 88,00€

8,47 - 2 120



Capacidade	20T
Altura mínima	190mm
Altura máxima	335mm
Peso	8,47Kg
Dimensões (CxLxA)	175x200x160mm

50825 154,00€

7,62 - 2 96



Capacidade	30T
Altura mínima	285mm
Altura máxima	465mm
Peso	7,62Kg
Dimensões (CxLxA)	140x150x250mm

MACACO TIPO GARRAFA COM CAIXA PLÁSTICA

51905 34,50€

2,90 - 6 144



Capacidade	2T
Altura mínima	181mm
Altura máxima	345mm
Peso	2,90Kg
Dimensões (CxLxA)	110x165x245mm

51906 39,00€

3,53 - 4 128



Capacidade	3T
Altura mínima	194mm
Altura máxima	371mm
Peso	3,53Kg
Dimensões (CxLxA)	110x170x280mm

51907 48,00€

4,59 - 4 128



Capacidade	5T
Altura mínima	216mm
Altura máxima	413mm
Peso	4,59Kg
Dimensões (CxLxA)	200x130x290mm

54001

285,00€

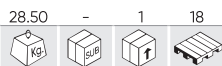

MACACO HIDRÁULICO DE FOSSA 0,5T



REPOSIÇÕES DISPONÍVEIS



VÍDEO TUTORIAL

Peças	1
Capacidade	500Kg
Altura mínima	1100mm
Altura máxima	1900mm
Peso	28,50Kg
Medidas da cabeceira	650x650x1100mm

50830

560,00€



MACACO HIDRÁULICO DE TRANSMISSÃO 0,5 TON.



REPOSIÇÕES DISPONÍVEIS

Peças	1
Capacidade	500Kg
Altura mínima	850mm
Altura máxima	1740mm
Peso	52,10Kg
Dimensões (CxLxA)	970x970x900mm

CONJUNTO DE 2 PREGUIÇAS

REF.	T	mm					€
53779	3T	290-430mm	4.85	-	1	72	36,00€
53845	6T	370-610mm	9.35	-	1	30	64,00€
54143	12T	500-770mm	35.50	-	1	12	249,00€



CONJUNTO DE 2 PREGUIÇAS 10 TON

REF.	T	mm					€
54145	10T	482-775mm	3.790	-	1	4	377,00€
54146	10T	736-1212mm	2.00	-	1	4	492,00€



54144

298,00€

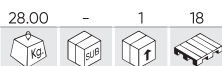

CONJUNTO DE 2 SUPORTES DE MACACO 22 TON (338-500MM)



Peças	2
Capacidade	22T
Altura mínima	338mm
Altura máxima	500mm
Peso	28,00Kg
Dimensões (CxLxA)	250x250x338mm

54147

199,00€



CAVALETE DE ELEVAÇÃO 1,8 TON (1220-2146MM)



Peças	1
Capacidade	22T
Altura mínima	1220mm
Altura máxima	2146mm
Peso	18,00Kg
Dimensões (CxLxA)	620x520x1220mm

51901

999,00€

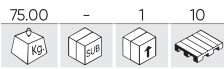

PORTA RODAS HIDRÁULICO 1T



Capacidade	1T
Altura mínima	50mm
Altura máxima	320mm
Diâmetro máximo da roda	1320mm
Peso	75,00Kg
Dimensões (CxLxA)	1040x890x1090mm

53218

26,00€

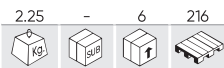

MACACO DE TESOURA 1.5T



Peças	2
Capacidade	1,5T
Altura mínima	90mm
Altura máxima	370mm
Peso	2,25Kg
Dimensões (CxLxA)	430x90x90mm

52241

1.690,00€



PORTA RODAS HIDRÁULICO 1.5T



Capacidade	1,5T
Altura mínima	0mm
Altura máxima	770mm
Diâmetro máximo da roda	2200mm
Peso	120,00Kg
Dimensões (CxLxA)	1270x990x1340mm

54257

318,00€

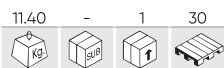

BOMBA HIDRÁULICA MANUAL 1.2L



Capacidade	1,2L
Pressão máxima	69BAR
Fluxo de trabalho	0-20Kg/cm3-20-700Kg/cm3
Conectores	3/8"NPT
Peso	11,40Kg
Dimensões (CxLxA)	750x180x270mm

50835

290,00€



DOBRADORA DE TUBOS 12T



Capacidade	12T
Pressão do trabalho	7,5-8,5BAR
Conectores	1/2", 3/4", 1"-1/4", 1"-1/2", 2"
Nível de ângulo	90°
Peso	35,50Kg
Dimensões (CxLxA)	680x585x185mm

53880

598,00€

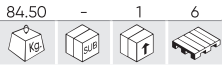

PORTA PALETES MANUAL ELEVAÇÃO RÁPIDA

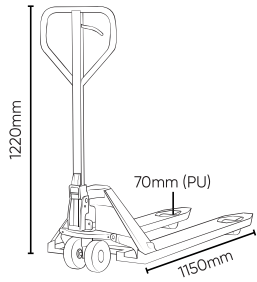

REPOSIÇÕES DISPONÍVEIS



VÍDEO TUTORIAL



Capacidade	2500Kg
Altura mínima de elevação	85mm
Altura máxima de elevação	200mm
Raio de giro	1266mm
Velocidade de elevação (com/sem carga)	0,0006-0,0007m/s
Tipo	Freno manual/Manual brake
Peso	84,50Kg
Dimensões (CxA)	1220x1150mm

54396

2.250,00€



EMPILHADOR DE PALETES ELÉCTRICO 1500KG

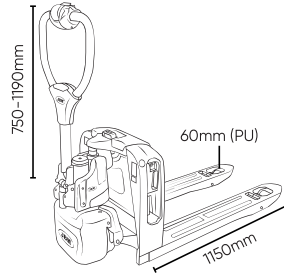

REPOSIÇÕES DISPONÍVEIS



Capacidade	1500Kg
Altura mínima de elevação	85mm
Altura máxima de elevação	190mm
Raio de giro	1360mm
Velocidade de deslocamento (com/sem carga)	4-4,5Km/h
Velocidade de elevação (com/sem carga)	0,017-0,020m/s
Potência	0,75KW
Tipo	Freno electromagnético/Electromagnetic brake
Tipo de pilha	LI-ION
Tensão da bateria	24V
Capacidade da bateria	20Ah
Tempo de carregamento	3-4h
Peso	112,00Kg
Dimensões (CxA)	1190x1150mm

50839

180,00€

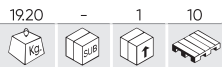

PORTA CARROS HIDRÁULICO 680KG



REPOSIÇÕES DISPONÍVEIS

Capacidade	680Kg
Abertura	345-660mm
Peso	1920Kg
Dimensões (CxLxA)	680x625x230mm

50923

454,00€

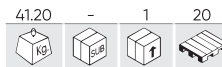

CARRO TRANSPORTADOR ESP. CHAPEIROS 340KG



REPOSIÇÕES DISPONÍVEIS

Capacidade	340Kg
Abertura	0-1100mm
Peso	41,20Kg
Dimensões (CxLxA)	1340x250x240mm

54679 389,00€

4700 - 1 16

PRENSA HIDRÁULICA DE MESA 10T

Capacidade	10T
Curso do pistão	154mm
Faixa de trabalho	200-370mm
Operado	Hidráulico manual/Hydraulic by hand
Largura de trabalho	350mm
Pistão com deslocamento lateral	Si/Yes
Peso	47,00Kg
Dimensões (CxLxA)	550x500x1028mm



REPOSIÇÕES
DISPONÍVEIS



53684 1.880,00€

191.00 - 1 7

PRENSA HIDRÁULICA 30 TON



REPOSIÇÕES
DISPONÍVEIS



Capacidade	30T
Curso do pistão	150mm
Faixa de trabalho	166-1126mm
Velocidades	2
Operado	Hidráulico manual o de pedal/Hydraulic by hand or foot
Peso	191,00Kg
Dimensões (CxLxA)	1920x750x290mm

53590 1.190,00€

114.50 - 1 8

PRENSA HIDRÁULICA 20 TON



REPOSIÇÕES
DISPONÍVEIS



Capacidade	20T
Curso do pistão	145mm
Faixa de trabalho	58-1018mm
Velocidades	2
Operado	Hidráulico manual o de pedal/Hydraulic by hand or foot
Peso	114,50Kg
Dimensões (CxLxA)	1670x730x255mm

REF.	DESCRIÇÃO					€
52999	BASE DE TRABALHO PARA PRENSA	7.70	-	2	130	211,00€

52514 84,00€

4.00 - 1 26

SUPORE ELEVADOR DE MOTAS 200KG



REPOSIÇÕES
DISPONÍVEIS



Capacidade	200Kg
Peso	4,00Kg
Dimensões (CxLxA)	750x400x530mm

51751 99,00€

5.00 - 4 12

SUPORE ELEVADOR DE MOTAS 200KG



REPOSIÇÕES
DISPONÍVEIS



Capacidade	200Kg
Peso	5,00Kg
Dimensões (CxLxA)	830x400x660mm

50831

460,00€

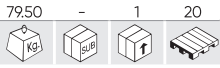

GRUA DE 2 TON DOBRÀVEL



REPOSIÇÕES DISPONÍVEIS

Capacidade	2T
Dimensões dobradas	1480x980x800mm
Tipo de fluido	Aceite pistón/Piston Oil ~ SAE 32
Altura máxima de elevação	0-2170mm
Modos de carregamento	4
Peso	79,50Kg
Dimensões (CxLxA)	1480x1650x920mm

52985

598,00€



GRUA DE 1T DOBRÀVEL



REPOSIÇÕES DISPONÍVEIS

Capacidade	1T
Dimensões dobradas	1470x300x180mm
Tipo de fluido	Aceite hidráulico/Hydraulic oil HL, HM
Altura máxima de elevação	85-2200mm
Modos de carregamento	3
Peso	74,00Kg
Dimensões (CxLxA)	1400x950x1460mm

50840

138,00€



SUPORTE PARA MOTORES 500KG (1750MM)



REPOSIÇÕES DISPONÍVEIS

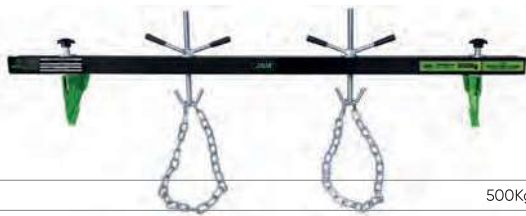

Capacidade	500Kg
Comprimento	1750mm
Peso	20,45Kg

52055

139,00€

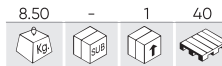

SUPORTE DE MOTOR UNIVERSAL 500KG



Capacidade	500Kg
Peso	8,50Kg
Dimensões (CxLxA)	1000x500x320mm

50631

68,00€

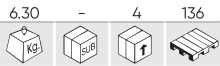

SUPORTE ALINHADOR DE MOTOR 750KG



Capacidade	750Kg
Peso	6,30Kg
Dimensões (CxLxA)	460x200x55mm

54757

135,00€

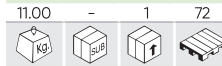

2T SUPORTE TRANSVERSAL PARA MACACO HIDRÁULICO



Compatível com	50818, 53112
Capacidade	1350-2000Kg
Comprimento	700-925mm
Altura de trabalho	50-130mm
Peso	10,00Kg
Dimensões (CxLxA)	700x120x140mm

50836

148,00€

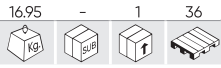

SUPORE PARA MOTORES 340KG



Capacidade	340Kg
Peso	21,00Kg
Dimensões (CxLxA)	900x800x850mm

50838

299,00€



SUPORE PARA MOTORES 900KG



Capacidade	900Kg
Peso	43,90Kg
Dimensões (CxLxA)	1100x900x900mm

TALHA DE CORRENTE MANUAL

REF.	DESCRIÇÃO					€
54262	1T 304N	10.40	-	1	90	88,00€
54263	2T 310N	14.00	-	1	80	130,00€
54264	5T 361N	36.00	-	1	32	240,00€



53423

199,00€

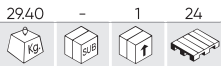

MACACO ELEVAÇÃO QUAD 680KG

Capacidade	680Kg
Altura mínima	118mm
Altura máxima	368mm
Peso	29,40Kg
Dimensões (CxLxA)	815x390x155mm



REPOSIÇÕES DISPONÍVEIS

52845

170,00€

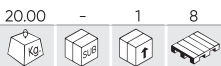

SET DE 2 RAMPA PARA ELEVAR 1 TON



Peças	2
Capacidade	1T
Altura de elevação	0-200mm
Peso	20,00Kg
Dimensões (CxLxA)	940x300x210mm

53969

96,00€



ELEVADOR DE MOTAS 150KG



Peças	2
Capacidade	150Kg
Altura mínima	300mm
Altura máxima	400mm
Peso	6,00Kg
Dimensões (CxLxA)	340x310x320mm

54386

5.839,00€

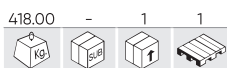

ELEVADOR PARA MONTAGEM DE BATERIAS EM VEÍCULOS ELÉCTRICOS 1200KG



REPOSIÇÕES DISPONÍVEIS



VÍDEO TUTORIAL



Capacidade	1200Kg
Altura máxima de elevação	1840mm
Altura mínima de elevação	650mm
Dimensões da plataforma	1290x768mm
Dimensões da plataforma alargada	1400x768mm
Tempo de elevação (sem carga)	24s
Tempo de descida (sem carga)	140s
Incluindo o suporte	Si/Yes
Peso	418,00Kg
Dimensões (CxLxA)	1840x770x650mm

54564

5.511,00€



ELEVADOR PARA MONTAGEM DE BATERIAS EM VEÍCULOS ELÉCTRICOS SEM SUPORTES 1200KG



REPOSIÇÕES DISPONÍVEIS



Capacidade	1200Kg
Altura máxima de elevação	1840mm
Altura mínima de elevação	650mm
Dimensões da plataforma	1290x768mm
Dimensões da plataforma alargada	1400x768mm
Tempo de elevação (sem carga)	24s
Tempo de descida (sem carga)	140s
Incluindo o suporte	No
Peso	418,00Kg
Dimensões (CxLxA)	1840x770x650mm

52692

129,00€



MESA PARA MOTAS 500KG



Capacidade	500Kg
Altura mínima	95mm
Altura máxima	400mm
Peso	13,20Kg
Dimensões (CxLxA)	540x350x100mm

50911

788,00€



MESA HIDRÁULICA PARA MOTAS 365KG



REPOSIÇÕES DISPONÍVEIS



Capacidade	365Kg
Altura mínima	205mm
Altura máxima	780mm
Peso	135Kg
Dimensões (CxA)	2200x490mm

53246

1.144,00€



MESA HIDRÁULICA 360KG



Capacidade	360Kg
Altura mínima	360mm
Altura máxima	1290mm
Peso	104,00Kg
Dimensões (CxLxA)	712x500x1290mm

50630

590,00€



MESA ELEVADORA PARA MOTAS 400KG



REPOSIÇÕES DISPONÍVEIS



Capacidade	400Kg
Altura mínima	290mm
Altura máxima	780mm
Peso	63,00Kg
Dimensões (CxLxA)	840x480x780mm

BASE DE ELEVADOR DE GOMA PARA ELEVADOR

54349 8,00€

0.48 - 68 2040

A	160mm
B	120mm
C	20mm

54350 12,50€

0.67 - 48 1248

A	160mm
B	120mm
C	30mm

54351 14,00€

0.97 - 32 928

A	160mm
B	120mm
C	40mm

54352 18,00€

1.43 - 20 640

A	160mm
B	120mm
C	60mm

54353 23,50€

1.85 - 12 456

A	160mm
B	120mm
C	80mm

54354 34,50€

2.91 - 9 312

A	160mm
B	120mm
C	120mm

54483 14,00€

0.70 - 40 1440

A	120mm
B	120mm
C	35mm

54484 26,00€

1.75 - 20 520

A	160mm
B	120mm
C	70mm

54485 36,00€

2.40 - 8 368

A	160mm
B	120mm
C	100mm

54355 12,00€

0.20 - 60 3240

RAVAGLIOLI/SIRIO/SPACE

A	123mm	D	108mm
B	26mm	E	10mm
C	104mm		

54360 14,00€

0.19 - 72 3888

RAVAGLIOLI/SIRIO/SPACE

A	130mm	D	125mm
B	23mm	E	10mm
C	121mm		

54486 9,50€

0.10 - 120 6480

RAVAGLIOLI/SIRIO/SPACE

A	100mm	D	85mm
B	22mm	E	8,5mm
C	81mm		

54488 15,00€

0.26 - 40 2160

RAVAGLIOLI

A	150mm	D	135mm
B	25mm	E	10mm
C	128mm		

54493 13,50€

0.19 - 60 3240

RAVAGLIOLI

A	120mm
B	110mm
C	27mm

54494 14,00€

0.30 - 48 2592

RAVAGLIOLI

A	145mm
B	135mm
C	26mm

54357 15,00€

0.29 - 60 3240

TWIN BUSCH

A	120mm	D	105mm
B	30mm	E	8,5mm
C	100mm	F	66mm

54358 18,50€

0.36 - 44 2376

TWIN BUSCH

A	140mm	D	123mm
B	30mm	E	10mm
C	115mm	F	50mm

54361 14,00€

0.25 - 52 2808

TWIN BUSCH

A	140mm	D	125mm
B	28mm	E	8mm
C	120mm		

54363 14,00€

0.30 - 44 2376

ISTOBAL/VELYEN

A	155mm	D	147mm
B	24mm	E	6mm
C	140mm		

54365 12,50€

0.20 - 108 4968

ISTOBAL/VELYEN

A	145mm
B	10mm
C	60mm

BASE DE ELEVADOR DE GOMA PARA ELEVADOR

54359 14,00€

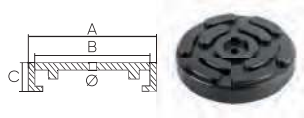

OMCN

A	140mm
B	133mm
C	27mm

54491 17,50€

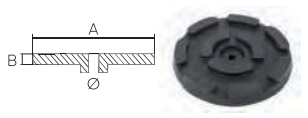

OMCN

A	145mm
B	25mm

54366 18,50€

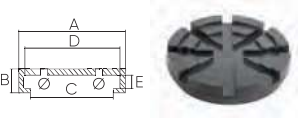
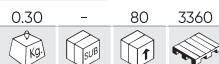

NASSBAUM/AMI

A	125mm	D	120mm
B	24mm		
C	90mm		

54362 14,00€

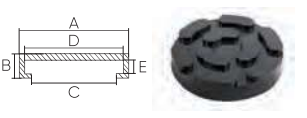

CASCOS

A	138mm	D	130mm
B	25mm	E	9mm
C	120mm		

54487 15,00€

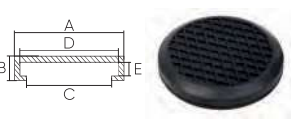

ROTARY

A	123mm	D	112mm
B	22mm	E	8mm
C	90,5mm		

54495 18,00€

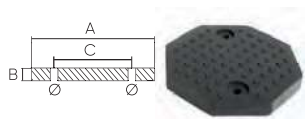

ROTARY

A	125mm
B	15mm
C	90mm

54496 16,50€

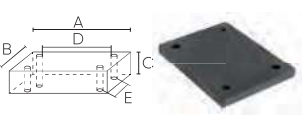

ROTARY

A	104mm	D	80mm
B	82mm	E	56mm
C	8mm		

54497 12,50€



MAHA

A	120mm	D	113mm
B	22mm	E	8mm
C	102mm	F	83mm

54492 19,50€

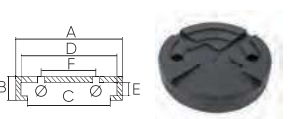

SLIFT/IME

A	125mm	D	110mm
B	25mm	E	9mm
C	102mm	F	83mm

54356 19,50€

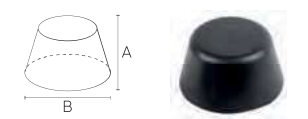

500E/500X/JEEP RENEGADE

A	55mm
B	100mm

54364 14,00€

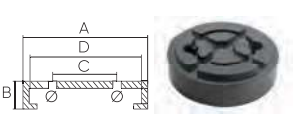
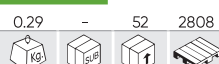

LAUNCH/TWIN BUSCH/RP TOOLS

A	120mm	D	108mm
B	32mm		
C	70mm		

54489 19,50€

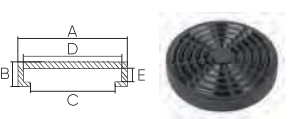

KONI/ROMERICO/CAR-O-LINER

A	160mm	D	153mm
B	29mm	E	10mm
C	140mm		

54490 15,00€

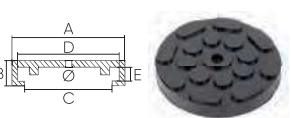

ATH/HOFMANN/
HERMANN/J.A.B. BECKER

A	120mm	D	110mm
B	19mm	E	4mm
C	103mm		

54761 56,50€

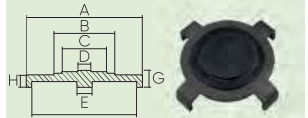

TESLA

A	130mm	E	20mm
B	80mm	F	120mm
C	58mm	G	30mm
D	17mm	H	16mm

54762 59,00€

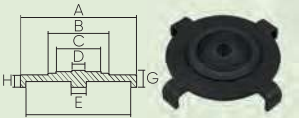

TESLA

A	150mm	E	20mm
B	80mm	F	140mm
C	58mm	G	30mm
D	17mm	H	16mm

54763 60,50€

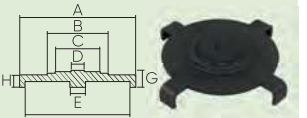

TESLA

A	170mm	E	20mm
B	80mm	F	160mm
C	58mm	G	30mm
D	17mm	H	16mm

54175



CONJUNTO DE 4 BASES DE ELEVACÃO TESLA

Marcas	Tesla 3/Y/S/X
Peso	0,80Kg
Dimensões (CxLxA)	200x200x60mm



34,00€

FERRAMENTAS ELÉTRICAS

ARRANCADOR	382	EQUIPAMENTO PARA OFICINA	390
MANUTENÇÃO DE BATERIAS	383	CLIMATIZAÇÃO	395
MEDIÇÃO DE CORRENTE	384	TERMÓMETROS	397
INSPEÇÃO VISUAL	386	OUTROS	397
SOLDADORA	388		



CABOS DE ARRANQUE

PINÇA MACIÇA DE LATÃO

REF.	Ø CABO	LONGO	AH	V					€
51238	14mm	5m	700Ah	12-24V	4.95	-	2	84	138,00€
51239	15mm	7m	700Ah	12-24V	5.90	-	2	78	159,00€

PINÇA DE LATÃO

REF.	Ø CABO	LONGO	AH	V					€
52069	12mm	2,5m	250Ah	12V	1.55	-	10	45	29,50€
52070	12mm	3m	350Ah	12V	1.95	-	5	76	40,00€
52071	12mm	3m	500Ah	12V	2.35	-	5	62	47,00€

PINÇA MACIÇA DE LATÃO COM PROTETOR DE SOBRECARGA

REF.	Ø CABO	LONGO	AH	V					€
51363	12mm	3m	350Ah	12V	2.63	-	5	160	114,00€
51365	12mm	3m	500Ah	12V	3.10	-	5	90	118,00€



PINÇA MACIÇA

REF.						€
14145	● COBRE	0.20	-	30	112	8,50€
14146	● COBRE	0.20	-	30	112	8,00€
14147	● LATÃO	0.35	-	15	162	25,50€
14148	● LATÃO	0.35	-	15	162	25,50€



14145 - 14146



14147 - 14148

53687

298,00€

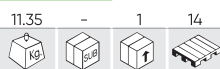

ARRANCADOR DE BATERIA 12V



REPOSIÇÕES DISPONÍVEIS

Tensão	12V
Bateria	22Ah
Corrente de partida	750A
Corrente máxima	1500A
Peso	11,35Kg
Dimensões (CxLxA)	392x209x370mm

53688

495,00€



ARRANCADOR DE BATERIAS 12/24V



REPOSIÇÕES DISPONÍVEIS

Tensão	12-24V
Bateria	22Ah
Corrente máxima (12V)	1500-3000A
Corrente máxima (24V)	750-1500A
Peso	18,05Kg
Dimensões (CxLxA)	392x209x370mm

51816

58,00€

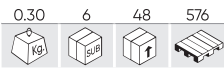

COMPROVADOR DE BATERIAS DIGITAL



Compatível com	Baterias/Batteries 12V
Peso	0,30Kg
Dimensões (CxLxA)	70x18x120mm

51235

49,00€



COMPROVADOR DE BATERIAS



Compatível com	Baterias/Batteries 6-12V
Peso	1,25Kg
Dimensões (CxLxA)	330x170x90mm

52884

79,00€

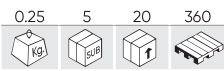

ARMAZENAMENTO DE MEMÓRIA PARA A SUBSTITUIÇÃO DAS BATERIAS



Compatível com	Baterias/Batteries 12V
Comprimento do cabo	2070mm (+/- 20mm)
Comprimento da conexão do queimador	235mm (+/- 20mm)
Peso	0,25Kg

53209

8,50€

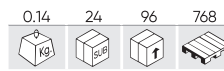

DENSÍMETRO DE BATERIAS



Compatível com	Baterias/Batteries 6-12-24V
Comprimento	270mm
Peso	0,14Kg

53927

66,00€

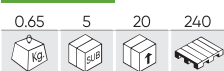

CARREGADORE DE BATERIA 6/12V



Tensão máxima de entrada	100-200V
Tensão máxima de saída	7,2V
Potência	60W
Corrente de carga máxima	3,6A
Corrente de carga mínima	0,9A
Temperatura de trabalho	0/40°C
Comprimento do cabo de entrada	1,5m
Comprimento do cabo de saída	1,5m
Tipo	Carga automática/Automatic charge
Compatível com	Baterias/Batteries 6-12V
Peso	0,65Kg

53929

95,00€



CARREGADORE DE BATERIA 12/24V



Tensão máxima de entrada	100-240V
Tensão máxima de saída	14,4-14,7V
Potência	150W
Corrente de carga máxima	7,2A
Corrente de carga mínima	3,6A
Temperatura de trabalho	-20/40°C
Comprimento do cabo de entrada	1,8m
Comprimento do cabo de saída	1,5m
Tipo	Carga automática/Automatic charge
Compatível com	Baterias/Batteries 12-24V
Peso	0,90Kg

52233

328,00€

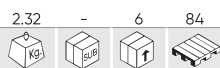

COMPROVADOR DE BATERIAS E ALTERNADORES COM IMPRESSORA

Bateria	AGM, VRLA, GEL, SLI
Aplicável	12, 24V
Faixa	40-2000CCA (SAE)
Comprimento do cabo	1800mm
Peso	2,23Kg

CONTÉM
x1 Rolo de papel térmico



REPOSIÇÕES DISPONÍVEIS



54040

240,00€

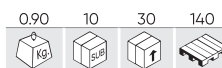

COMPROVADOR DE BATERIA COM IMPRESSORA

Bateria	AGM, GEL, VRLA, SLI
Aplicável	12, 24V
Faixa	100-2000CCA (SAE)
Comprimento do cabo	550mm
Peso	0,90Kg

CONTÉM
x2 Rolo de papel térmico
x1 Bateria CR2032



REPOSIÇÕES DISPONÍVEIS



54557

78,00€

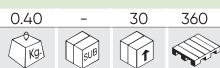

DETETOR DE TENSÃO

Tensão	12-1000V
Frequência	40-400Hz
Temperatura de trabalho	-10/55°C
Peso	0,40Kg
Dimensões (CxLxA)	320x90x55mm



54559

18,60€

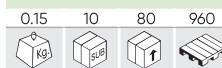

DETETOR DE TENSÃO SEM CONTACTO

Tensão	50-1000V
Frequência	50-60Hz
Temperatura de trabalho	0/50°C
Peso	0,15Kg
Dimensões (CxLxA)	143x25x21mm



COMPROVADOR DE CIRCUITOS

REF.	V	mm					€
53028	6, 12, 24V	1.8x190mm	0.70	10	120	1200	5,80€
53029	6, 12, 24V	2x115mm	0.08	12	240	2400	6,80€
53030	6, 12, 24V	3x142mm	0.17	6	60	720	12,00€



53028



53029



53030

54114

248,00€

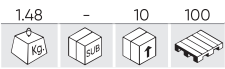

MEDIDOR DE ISOLAMENTO

Tensão	AC / DC
Medição de voltagem em corrente alternada (AC)	0-750V
Medição de voltagem em corrente contínua (DC)	0-1000V
Medição de resistência (Ω)	0-200Ω, 200-2000Ω, 0-200mΩ, 200-2000mΩ
Ambiente operacional	0°C/40°C
Ambiente de armazenamento	-10°C/60°C
Bateria	6 Pilas/Batteries AA
Categoria de medição	CAT III
Categoria de instalação	2
Peso	1,48Kg
Dimensões (CxLxA)	200x92x55mm



54256

48,00€

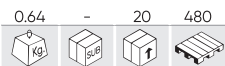

PROTECTOR DE PICOS AUTOMÁTICO 12/24V

Tensão	12-24V
Tensão máxima DC	35V
Corrente de pico máximo	800Amps
Máxima absorção	1500W
Peso	0,45Kg



52231

53,00€

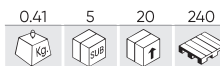

KIT DE ACESSÓRIOS PARA MULTÍMETRO

CONTÉM

- x2 Sondas
- x2 Pinças pequenas
- x2 Pinças largas
- Cabos de extensão



52439

227,00€

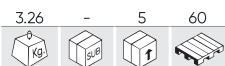

JOGO DE CABOS E ACC PARA MULTÍMETRO

CONTÉM

- x2 Medidores de resistência variável
- x2 Luzes led de comprovação
- x2 SRS substituição e dois dispositivos de proba
- x2 Alicates de crocodilo
- x2 Tomas de engate rápido
- x4 Sondas
- x24 Conectores redondos
- x48 Conectores lisos



52382

19,50€

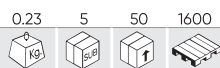

PINÇA AMPERIMÉTRICA

DCB	600V
ACB	600V
DCA	-
ACA	20A, 200A, 600A
OHM	2KΩ, 200KΩ, 2MΩ



Tensão	AC / DC
Ambiente de armazenamento	0°C/40°C
Ambiente operacional	-10°C/40°C
Bateria	2 Pilas/Batteries AAA
Peso	0,26Kg
Dimensões (CxLxA)	167x55x22mm

52952

74,00€

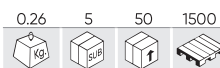

PINÇA AMPERIMÉTRICA PROFESIONAL

DCB	20V, 600V
ACB	600V
DCA	200A
ACA	200A
OHM	2000Ω



Tensão	AC / DC
Ambiente operacional	0°C/40°C
Ambiente de armazenamento	-10°C/40°C
Bateria	2 Pilas/Batteries AAA
Peso	0,26Kg
Dimensões (CxLxA)	175x53x25mm

50942

28,00€

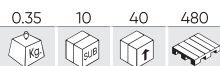

MULTÍMETRO DIGITAL

Medição de voltagem em corrente alternada (AC)	200mV, 2V, 20V, 200V, 1000V
Medição de voltagem em corrente contínua (DC)	200mV, 2V, 20V, 200V, 750V
Medição de intensidade de corrente alternada (AC)	20mA, 200mA, 20A
Medição de intensidade de corrente contínua (DC)	20mA, 200mA, 20A
Medição de resistência (Ω)	200Ω, 2KΩ, 20KΩ, 200KΩ, 2MΩ, 20MΩ, 2000MΩ
Medição de capacitância (F)	2nF, 20nF, 200nF, 2μF, 20μF, 200μF
Temperatura de trabalho	-40°C /1000 °C
Peso	0,35Kg
Dimensões (CxLxA)	190x90x33mm



54706

58,00€

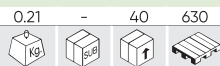

ENDOSCÓPIO COM WIFI

Quadros	25FPS
Comprimento do cabo	1m
Diâmetro da câmara	8mm
Gama de focagem	70°
Proteção IP	IP67
Capacidade da bateria	850mAh
Tempo de trabalho	2,5h
Tempo de carregamento	1,5h
Compatível com	iOS, Android
Ângulo de visão	70°
Brilho	24Lm



VÍDEO TUTORIAL

Tipo de carga	TYPE-C
Medidas da cabeceira	41x8mm
Peso	0,210Kg
Dimensões (CxXa)	98,5x38,5mm

53484 579,00€

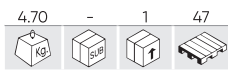

DETECTOR DE VAZAMENTO DE GÁS 16L/MIN



VÍDEO TUTORIAL



REPOSIÇÕES DISPONÍVEIS



Tensão	12V
Caudal	16L/min
Pressão de ensaio	15PSI
Peso	4,70Kg
Dimensões (CxLxA)	275x220x265mm

54524 298,00€



DETECTOR DE VAZAMENTO DE FUMAÇA 8L/MIN



VÍDEO TUTORIAL



REPOSIÇÕES DISPONÍVEIS



Tensão	12V
Caudal	8L/min
Pressão de ensaio	15PSI
Peso	2,20Kg
Dimensões (CxLxA)	195x125x125mm

54685 105,00€

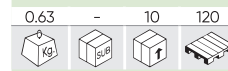

DETECTOR DE FUGAS POR ULTRASSONS

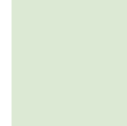

VÍDEO TUTORIAL



REPOSIÇÕES DISPONÍVEIS



Tensão	9V
Frequência das ondas ultra-sónicas	40kHz
Temperatura de trabalho	0 ~ -40°C
Peso	0,21Kg
Dimensões (CxLxA)	192x50x30mm



14081 11,90€

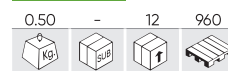

ÓLEO PARA MÁQUINA DETECÇÃO POR FUMO



54707



CÂMARA DE TERMOGRAFIA

Tela	2,4 LCD TFT
Resolução	320x240px
Emissividade	0,01~0,99LCD
Precisão	±2°C
Faixa	-20/400°C
Distância focal	0,1m
Visualização	6 Filtros/Filters
Bateria	Li-ion 3.7V/2600mAh 18650
Porta de carga	USB C
Peso	0,31Kg
Dimensões (CxLxA)	197x72x60mm



VÍDEO TUTORIAL



437,00€

54561

93,00€



SOLDADOR DE PLÁSTICO PARA REPARAÇÃO DE CARROÇARIAS

Tensão nominal	3,7V
Potência	18W
Bateria	2600mAh Li-ion
Inclui	200 Grapas/Staples
Tempo de carregamento	3H
Tempo de trabalho	200-500 Grapadas/Staples
Carregador	Tipo C/ Type C
Temperatura de trabalho	500°C
Peso	1,00Kg
Dimensões (CxLxA)	27,5x49,5x198,2mm



53145

39,20€



PISTOLA DE CALOR 1600W



Tensão	220-240V
Potência	1600W
Frequência	50-60Hz
Temperatura de trabalho	400/600°C
Taxa de fluxo de ar	250-550L/min
Peso	0,95Kg

53162

60,00€



PISTOLA DE CALOR DIGITAL 2000W



Tensão	220-240V
Potência	2000W
Frequência	50-60Hz
Temperatura de trabalho	100/600°C
Taxa de fluxo de ar	280-480L/min
Peso	0,80Kg

53977

17,50€

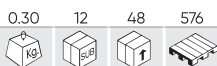

SOLDADOR 40W



Tensão	220-240V
Potência	40W
Frequência	50Hz
Temperatura de trabalho	450°+/-10%
Comprimento	240mm
Comprimento do cabo	1,3m

53111

19,30€

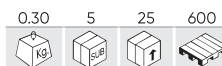

MAÇARICO DE SOLDA 100W



Tensão	220-240V
Potência	100W
Frequência	50Hz
Temperatura de trabalho	420°+/-10%
Comprimento	250mm
Comprimento do cabo	1,5m

53981

143,00€

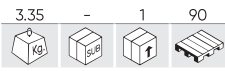

DISPOSITIVO PARA SOLDAGEM A ARCO ELÉTRICO MANUAL COM INVERSOR CC 100 A



REPOSIÇÕES DISPONÍVEIS



Tensão	230V
Frequência	50Hz
Potência	3,7KVA
Intensidade	16A
Tensão em vazio	65V
Tensão máxima de saída	24V
Fator de utilização	15%
Fator de potência	0,7
Eficiência	85%
Eletrodo	1,0 - 3,2mm
Classe de isolamento	F
Classe de proteção	IP21S
Peso	200x80x130mm
Dimensões (CxLxA)	3,350Kg

53982

219,00€

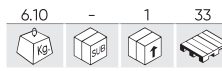

DISPOSITIVO PARA SOLDAGEM A ARCO ELÉTRICO MANUAL COM INVERSOR CC 160 A



REPOSIÇÕES DISPONÍVEIS



Tensão	230V
Frequência	50-60Hz
Potência	6,5KVA
Intensidade	29A
Tensão em vazio	65V
Tensão máxima de saída	26,4V
Fator de utilização	35%
Fator de potência	0,7
Eficiência	85%
Eletrodo	1,0 - 4,0mm
Classe de isolamento	F
Classe de proteção	IP21S
Peso	6,10Kg
Dimensões (CxLxA)	330x140x260mm

ESQUADRO MAGNÉTICO

REF.	mm	°	kg	box	box	box	box	€
54111	75mm	45, 90, 135°	0.35	10	40	1680	4,80€	
54113	100mm	45, 90, 135°	0.60	10	20	1100	8,00€	



53414

49,00€

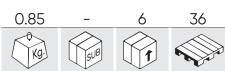

CAPACETE PARA SOLDAGEM COM REGULADOR MANUAL



BOTÃO ANALÓGICO PARA AJUSTAR A SENSIBILIDADE E ESCURECIMENTO

53415

188,00€

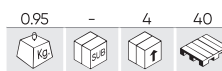

CAPACETE PARA SOLDAGEM COM REGULADOR DIGITAL



REGULADOR DIGITAL

54482

677,00€

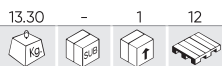

LIMPADOR ULTRASSÔNICO 30L



REPOSIÇÕES DISPONÍVEIS

Tensão	200-240V
Potência	500-600W
Frequência	50Hz
Frequência das ondas ultra-sônicas	40KHZ
Capacidade do depósito	30L
Número de transdutores	10
Temporizador	1-60min
Temperatura de trabalho	0/80°C
Peso	14,50Kg
Dimensões do depósito	500x300x200mm
Dimensões (CxLxA)	555x325x335mm

54733

3.360,00€



LIMPADOR ULTRASSÔNICO 53L



REPOSIÇÕES DISPONÍVEIS

Tensão	110-220V
Potência	900-1500W
Frequência	50Hz
Frequência das ondas ultra-sônicas	40KHZ
Capacidade do depósito	53L
Número de transdutores	18
Temporizador	1-99min
Temperatura de trabalho	20/95°C
Peso	95,00Kg
Dimensões do depósito	735x500x695mm
Dimensões (CxLxA)	735x500x815mm

17605

179,00€

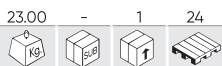

LÍQUIDO DE LIMPEZA POR ULTRA-SONS

Compatível com	54482, 54733
Capacidade	20L
Peso	23,00Kg
Dimensões (CxLxA)	280x240x410mm



52195

170,00€

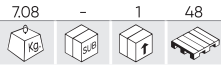

AMOLADORA DUPLA ELÉCTRICA 250W



Tensão	230V
Potência	250W
Frequência	50Hz
Velocidade	2950RPM
Tamanho da mó	150x20x12,7mm

53660

146,00€



BASE METÁLICA PARA AMOLADORA DE BANCADA



Altura	790mm
Medidas da bandeja superior	250x280mm
Compatível com	52195

53656

198,00€

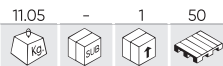

AMOLADORA DUPLA ELÉCTRICA 450W



53657

248,00€



AMOLADORA DUPLA ELÉCTRICA 600W



53658

99,00€

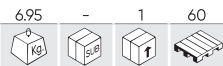

AMOLADORA DUPLA ELÉCTRICA 250W



53659

121,00€

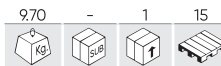

AMOLADORA DUPLA ELÉCTRICA 250W



	53656	53657	53658	53659
Tensão	230V	230V	230V	230V
Potência	450W	600W	250W	250W
Frequência	50Hz	50Hz	50Hz	50Hz
Velocidade	2950RPM	2950RPM	2950RPM	2950RPM
Tamanho da mó	150x20x12,7mm	200x25x15,88mm	150x20x12,7mm	150x20x12,7mm/200x40x20mm
Tampa protetora:	•	•	•	•
Proteção ocular:	•	•	•	•
Rebolo:	•	•	•	•
Botão de fixação do suporte:	•	•		
Barra de montagem:			•	•
Tanque de água:				•

54512

586,00€

5.66 - 1 28



AQUECEDOR DE INDUÇÃO 1KW



REPOSIÇÕES DISPONÍVEIS



Potência	1KW
Frequência	50Hz
Consumo de energia	4,16A
Potência de saída	0,8KVA
Fator de carga	0,58-0,975KVA
Proteção IP	IP20
Comprimento do cabo	1000mm
Comprimento do alargamento da indução	700mm
Peso	5,66Kg
Dimensões (CxLxA)	365x67x70mm

54522

1.299,00€

5.25 - 4 34



AQUECEDOR DE INDUÇÃO 1.5KW



REPOSIÇÕES DISPONÍVEIS



Potência	1,5W
Frequência	50-60Hz
Consumo de energia	8A
Potência de saída	3,2KVA
Fator de carga	0,95KVA
Proteção IP	IP20
Comprimento do cabo	1000mm
Comprimento do alargamento da indução	700mm
Peso	5,25Kg
Dimensões (CxLxA)	200x140x75mm

16872

79,00€

21.40 - 1 24



LÍQUIDO DETERGENTE PARA LIMPEZA DE PEÇAS MECÂNICAS (20L)

Compatível com	54342, 52980, 50632
Capacidade	20L
Peso	21,40Kg
Dimensões (CxLxA)	280x240x410mm



54342

858,00€

49.50 - 1 4



MÁQUINA LIMPADORA DE PEÇAS COM TERMÓSTATO 14L



REPOSIÇÕES DISPONÍVEIS



VÍDEO TUTORIAL

Capacidade do depósito	8-14L
Taxa de fluxo de ar	70-120PSI
Caudal de recirculação do agente de lavagem	0,8L/min
Temperatura máxima do termóstato	50°C
Peso	49,50Kg
Dimensões do depósito	740x560x452mm
Dimensões (CxLxA)	790x1260x610mm



54341 643,00€

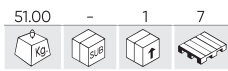

MÁQUINA DE JACTO DE AREIA 220L



REPOSIÇÕES DISPONÍVEIS VÍDEO TUTORIAL

Tensão	100-240V
Capacidade do depósito	220L
Capacidade de carga de areia	33L
Granulometria recomendada	60-80MESH
Taxa de fluxo de ar	40-120PSI
Peso	51,00Kg
Capacidade do depósito	860x560x560mm
Dimensões (CxLxA)	1390x905x632mm

54563 282,50€



MÁQUINA DE JACTO DE AREIA 90L



REPOSIÇÕES DISPONÍVEIS VÍDEO TUTORIAL

Tensão	12V
Capacidade do depósito	90L
Capacidade de carga de areia	6,5L
Granulometria recomendada	60-80MESH
Taxa de fluxo de ar	40-120PSI
Peso	19,30Kg
Capacidade do depósito	580x480x305mm
Dimensões (CxLxA)	580x485x494mm

52980 480,00€

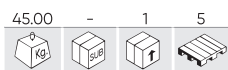

MÁQUINA DE LIMPEZA DE PEÇAS 150L



REPOSIÇÕES DISPONÍVEIS

Capacidade do tanque	90L
Taxa de entrega	2,7 - 3,6 L/min
Peso	42,00Kg
Dimensões do depósito	1060x490x270mm
Dimensões (CxLxA)	1090x540x890mm

50632 298,00€

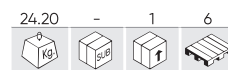

MÁQUINA DE LIMPEZA DE PEÇAS 80L



REPOSIÇÕES DISPONÍVEIS

Capacidade do tanque	45L
Taxa de entrega	2,7 - 3,6 L/min
Peso	23,20Kg
Dimensões do depósito	710x480x256mm
Dimensões (CxLxA)	760x540x880mm



51837

195,00€



ASPIRADOR INDUSTRIAL - SECO DE 30L



REPOSIÇÕES DISPONÍVEIS

Tensão	230V
Potência	1200W
Frequência	50Hz
Capacidade	30L
Litros de sucção por segundo	26L/s
Potência de sucção	17KPA
Proteção IP	IPX4
Comprimento da mangueira	1,5m
Comprimento do cabo	4,5m
Peso	8,25Kg

51838

667,00€



ASPIRADOR INDUSTRIAL DE 80L (SECO E HÚMEDO)



REPOSIÇÕES DISPONÍVEIS

Tensão	230V
Potência	1000W
Frequência	50Hz
Capacidade	80L
Litros de sucção por segundo	50L/s
Potência de sucção	20KPA
Proteção IP	IPX4
Comprimento da mangueira	2m
Comprimento do cabo	4,5m
Peso	28,00Kg

53947

145,00€

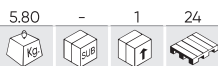

LAVADORA DE ALTA PRESSÃO 1400W



REPOSIÇÕES DISPONÍVEIS

Tensão	230V
Potência	1400W
Frequência	50Hz
Pressão do trabalho	70-105BAR
Fluxo máximo de operação	5,5-6,8L/min
Temperatura de trabalho	50°C
Proteção IP	IPX5
Peso	5,80Kg
Dimensões (CxLxA)	280X255X440mm

53948

324,00€



LAVADORA DE ALTA PRESSÃO 2400W



REPOSIÇÕES DISPONÍVEIS

Tensão	230V
Potência	2400W
Frequência	50Hz
Pressão do trabalho	120-180BAR
Fluxo máximo de operação	5,5-8L/min
Temperatura de trabalho	50°C
Proteção IP	IPX5
Peso	12,10Kg
Dimensões (CxLxA)	440x345x505mm

54229

48,00€

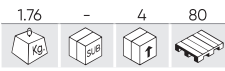

AQUECEDOR 2KW



54230

68,00€

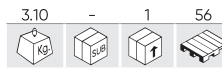

AQUECEDOR 3KW



54231

138,00€

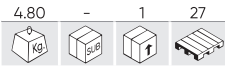

AQUECEDOR 5KW



54232

248,00€

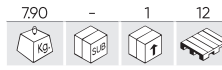

AQUECEDOR 9KW



	54229	54230	54231	54232
Tensão	220-240V	220-240V	380-400V	380-400V
Potência	1000-2000W	1500-3000W	3300-5000W	6000-9000W
Frequência	50Hz	50Hz	50Hz	50Hz
Área de aquecimento	20m ²	30m ²	48m ²	80m ²
Saída de ar	197m ³ /h	280m ³ /h	588m ³ /h	1180m ³ /h
Material	SPCC	SPCC	SPCC	SPCC
Peso	1,76Kg	3,10Kg	4,80Kg	7,90Kg
Dimensões (CxLxA)	210x160x217mm	265x210x290mm	300x235x345mm	395x307x455mm

54125

152,00€

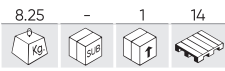

VENTILADOR NEBULIZADOR DE ÁGUA 75W



REPOSIÇÕES DISPONÍVEIS

Tensão	220-240V
Potência	75W
Frequência	50Hz
Velocidades	3
Capacidade	3,2L
Consumo de água	<220ml/h
Peso	8,25Kg
Dimensões (CxLxA)	430x400x125mm

54508

169,00€

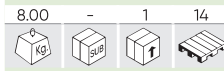

VENTILADOR DE PULVERIZAÇÃO DE ÁGUA 75W



Tensão	220-240V
Potência	75W
Frequência	50Hz
Velocidades	3
Capacidade	2,8L
Consumo de água	<220ml/h
Peso	8,00Kg
Dimensões (CxLxA)	430x380x1250mm

53189

128,00€

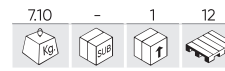

VENTILADOR DE PÉ 120W



Tensão	230V
Potência	120W
Frequência	50Hz
Velocidades	1050, 1150, 1300RPM/min
Peso	7,10Kg
Dimensões (CxLxA)	1240x400x550mm

53543

13,80€

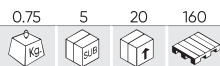

VENTILADOR DE VEÍCULO - 12 V



Tensão	12V
Potência	120W
Frequência	50Hz
Velocidades	2700-3100RPM/min
Peso	0,75Kg
Dimensões (CxLxA)	590x220x610mm

53190

98,00€

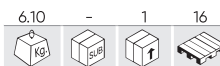

VENTILADOR DE CHÃO 120W



Tensão	230V
Potência	120W
Frequência	50Hz
Velocidades	1050, 1150, 1300RPM/min
Peso	6,10Kg
Dimensões (CxLxA)	230x620x575mm

54554

484,50€

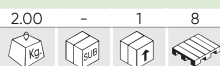

AR CONDICIONADO PORTÁTIL 2600W

Tensão	220-240V
Capacidade de desumidificação	1,0L/h
Capacidade de refrigeração	2600W
Potência de entrada	950W
Frequência	50Hz
Fluxo de ar	270m3/h
Espaço de aplicação	13-18m2
Unidade de calor	9000BTU
Refrigerante	R290
Diâmetro do cabo	155mm
Comprimento do cabo	1,5m
Peso	24,30Kg
Dimensões (CxLxA)	330x280x685mm



REPOSIÇÕES DISPONÍVEIS



Ar condicionado portátil é uma solução eficiente para refrigeração em vários ambientes, como casas, escritórios e veículos recreativos. Graças ao seu tamanho compacto e características práticas, proporciona alívio imediato em climas quentes sem a necessidade de instalações permanentes

- ✓ VENTILADOR
- ✓ DESUMIDIFICADOR
- ✓ REFRIGERAÇÃO



52162

38,00€

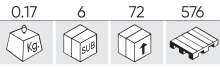

TERMÓMETRO LÁSER -50°C A 550°C



Tensão	9V
Gama de medição	-50/550°C
Precisão	±2°C
Emissividade	0.1-1.0
Tempo de resposta	500ms
Peso	0,17Kg
Dimensões (CxLxA)	145x37x90mm

52450

111,00€

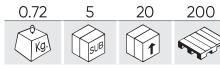

TERMÓMETRO LÁSER -50° ~1000°



Tensão	9V
Gama de medição	-50/1000°C
Precisão	±1,5°C
Emissividade	0.1-1.0
Tempo de resposta	500ms
Peso	0,72Kg
Dimensões (CxLxA)	175x105x48mm

51831

24,00€

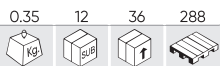

PISTOLA DE COLA TERMOFUSÍVEL



REPOSIÇÕES DISPONÍVEIS

Tensão	100-200V
Potência	60-150W
Temperatura de trabalho	190/230°C
Diâmetro do bocal	2,3mm
Peso	0,35Kg

53503

12,00€

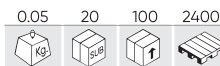

TERMÔMETRO DIGITAL DE CONTATO



Bateria	Pila/Battery 1.5V
Gama de medição	-50°C/+330°C
Precisão	±1°C
Unidades de medida	°C / °F
Peso	0,05Kg

51033

98,00€

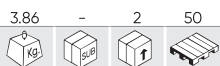

EXTENSÃO MANUAL DE CABO ELÉCTRICO 25M

Tensão	300V
Potência	1.110-3.200W
Comprimento do cabo	25m
Proteção IP	IP20
Cabo	H05W-F 3X1,5 mm2 (PVC)
Peso	3,86Kg
Dimensões (CxLxA)	320x230x155mm



EXTENSÃO DE CORRENTE ELÉCTRICA

REF.	m					€
53166	3m	0.45	5	30	600	11,30€
53167	5m	0.65	5	20	600	13,90€
53168	10m	1.20	-	10	300	26,00€



53585

168,00€



CARRETEL DE CABO ELÉCTRICO 21M - AZUL



REPOSIÇÕES DISPONÍVEIS



Tensão	230V
Potência	1000-3000W
Comprimento	20+1m
Proteção IP	IP44
Cabo	H07RN-F3G1.5mm2
Peso	8,35Kg
Dimensões (CxLxA)	320x205x340mm

53586

168,00€

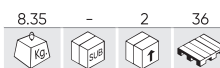

CARRETEL DE CABO ELÉCTRICO 21M - VERDE



REPOSIÇÕES DISPONÍVEIS



Tensão	230V
Potência	1000-3000W
Comprimento	20+1m
Proteção IP	IP44
Cabo	H07RN-F3G1.5mm2
Peso	8,35Kg
Dimensões (CxLxA)	320x205x340mm

53526

119,00€



CARRETEL DE CABO ELÉCTRICO 12M - AZUL



REPOSIÇÕES DISPONÍVEIS



Tensão	230V
Potência	1000-3000W
Comprimento	11+1m
Proteção IP	IP44
Cabo	H07RN-F3G1.5mm2
Peso	5,15Kg
Dimensões (CxLxA)	330x170x300mm

53584

119,00€



CARRETEL DE CABO ELÉCTRICO - 12M - VERDE



REPOSIÇÕES DISPONÍVEIS



Tensão	230V
Potência	1000-3000W
Comprimento	11+1m
Proteção IP	IP44
Cabo	H07RN-F3G1.5mm2
Peso	5,10Kg
Dimensões (CxLxA)	330x170x300mm



- ✓ COM REPARTIDOR
- ✓ PROTEÇÃO DIFERENCIAL DE SOBRECARGA
- ✓ BLOCO DE CABO



ENERGIA RENOVÁVEL E MOBILIDADE DO FUTURO

CABOS PARA CARREGAR DE CARROS ELÉTRICOS

400

CARREGADORES DE CARRO ELÉTRICO

400

FERRAMENTAS COM ISOLAMENTO

401



CABO DE CARREGAMENTO

REF.													€
54053	3.6KW	16A	-25° +55°	IP66	5m	TIPO 1 AO TIPO 2	SINGLE-PHASE	2.15	-	5	-		248,00€
54054	7.5KW	32A	-25° +55°	IP66	5m	TIPO 1 AO TIPO 2	SINGLE-PHASE	2.90	-	5	100		268,00€
54055	3.6KW	16A	-25° +55°	IP66	5m	TIPO 2 AO TIPO 2	SINGLE-PHASE	2.15	-	5	100		220,00€
54056	11KW	16A	-25° +55°	IP66	5m	TIPO 2 AO TIPO 2	TRIFÁSICO	2.85	-	5	102		260,00€
54057	7.5KW	32A	-25° +55°	IP66	5m	TIPO 2 AO TIPO 2	SINGLE-PHASE	2.95	-	5	102		248,00€
54058	22KW	32A	-25° +55°	IP66	5m	TIPO 2 AO TIPO 2	TRIFÁSICO	3.85	-	5	100		348,00€

TIPO 1-2 TYPE 1-2



TIPO 2-2 TYPE 2-2



CARREGADOR DE REDE

REF.											€	
52600	3.6KW	16A	-25° +55°	IP66		TIPO 2	SINGLE-PHASE	4.65	-	4	80	884,00€
52902	7.5KW	32A	-25° +55°	IP66		TIPO 2	SINGLE-PHASE	4.90	-	4	40	970,00€
52903	11KW	16A	-25° +55°	IP66		TIPO 2	TRIFÁSICO	5.25	-	1	40	1.100,00€



54265

1.290,00€

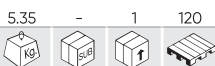

ESTAÇÃO DE CARREGAMENTO 22 KW, 32 A, PARA CARROS ELÉTRICOS (TRIFÁSICO)



REPOSIÇÕES DISPONÍVEIS

54059

428,00€



CARREGADOR PORTÁTIL 16 A MONOFÁSICO, COM CABO DE CARGA TIPO 2



REPOSIÇÕES DISPONÍVEIS

50942

28,00€

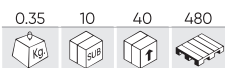

MULTÍMETRO DIGITAL

Medição de voltagem em corrente alternada (AC)	200mV, 2V, 20V, 200V, 1000V
Medição de voltagem em corrente continua (DC)	200mV, 2V, 20V, 200V, 750V
Medição de intensidade de corrente alternada (AC)	20mA, 200mA, 20A
Medição de intensidade de corrente continua (DC)	20mA, 200mA, 20A
Medição de resistência (Ω)	200Ω, 2KΩ, 20KΩ, 200KΩ, 2MΩ, 20MΩ, 2000MΩ
Medição de capacitância (F)	2nF, 20nF, 200nF, 2μF, 20μF, 200μF
Temperatura de trabalho	-40°C /1000 °C
Peso	0,35Kg
Dimensões (CxLxA)	190x90x33mm



52952

74,00€

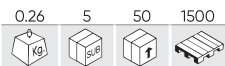

PINÇA AMPERIMÉTRICA PROFESIONAL



Tensão	AC / DC
Ambiente operacional	0°C/40°C
Ambiente de armazenamento	-10°C/40°C
Bateria	2 Pilas/Batteries AAA
Peso	0,26Kg
Dimensões (CxLxA)	175x53x25mm

52382

19,50€

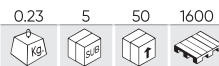

PINÇA AMPERIMÉTRICA



Tensão	AC / DC
Ambiente de armazenamento	0°C/40°C
Ambiente operacional	-10°C/40°C
Bateria	2 Pilas/Batteries AAA
Peso	0,26Kg
Dimensões (CxLxA)	167x55x22mm

54091

441,00€



MALETA DE FERREMENTA ISOLADA - 26PEÇAS



REPOSIÇÕES DISPONÍVEIS



54093

441,00€



MÓDULO EVA DE FERRAMENTA ISOLADA



REPOSIÇÕES DISPONÍVEIS



53154

462,00€

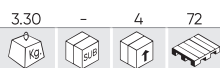

MALETA DE FERRAMENTA ISOLADA 20 PEÇAS DE 3/8"



54562

68,50€

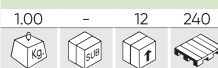

CONJUNTO DE CHAVES DE FENDAS INTERCAMBIÁVEIS 25PCS ISOLADAS



15162

32,50€

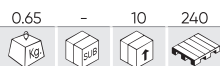

MÓDULO DE 8 CHAVES DE FENDAS ISOLADAS VDE



REPOSIÇÕES DISPONÍVEIS

52519

25,50€

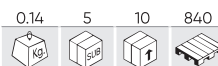

KIT DE 7 CHAVES ISOLADAS ATÉ 1.000V

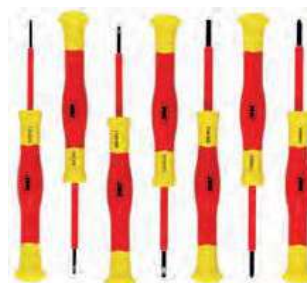

LUVAS ISOLANTES PARA TRABALHOS SOB TENSÃO

REF.	DESCRIÇÃO					€
54130	T.9	0.35	-	1	100	58,00€
54131	T.10	0.40	-	1	100	58,00€



53165

19,60€

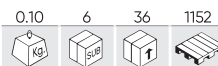

NAVALHA CORTA CABOS ISOLADA (CURVADA)



54114

248,00€

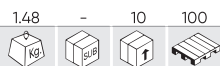

MEDIDOR DE ISOLAMENTO

Tensão	AC / DC
Medição de voltagem em corrente alternada (AC)	0-750V
Medição de voltagem em corrente continua (DC)	0-1000V
Medição de resistência (Ω)	0-200Ω, 200-2000Ω, 0-200mΩ, 200-2000mΩ
Ambiente operacional	0°C/40°C
Ambiente de armazenamento	-10°C/60°C
Bateria	6 Pilas/Batteries AA
Categoria de medição	CAT III
Categoria de instalação	2
Peso	1,48Kg
Dimensões (CxLxA)	200x92x55mm



54132 190,00€

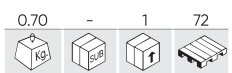

PROTEÇÃO FACIAL ISOLANTE PARA TRABALHOS SOB TENSÃO



Altura	205mm
Proteção	Clase I/Class I
Tipo	Tratamiento anti-vaho/Anti-fogging treatment
Peso	0,70Kg

54241 120,00€

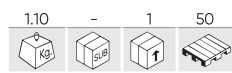

GANCHO DE RESGATE ISOLADO - 45KV



Tensão de funcionamento	45KV
Material	Fibra de vidro/Fiberglass, Resina poliéster/Polyester resin
Comprimento	1650mm
Peso	1,10Kg

54129 110,00€

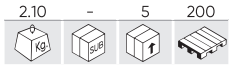

TAPETE ISOLANTE CLASSE 0



Medição de intensidade de corrente alternada (AC)	1000V
Medição de intensidade de corrente contínua (DC)	1500V
Proteção	Clase/Class 0
Peso	2,10Kg
Dimensões (CxLxA)	1000x600x2mm

54386 5.839,00€

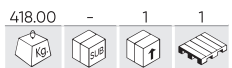

ELEVADOR PARA MONTAGEM DE BATERIAS EM VEÍCULOS ELÉCTRICOS 1200KG



Capacidade	1200Kg
Altura máxima de elevação	1840mm
Altura mínima de elevação	650mm
Dimensões da plataforma	1290x768mm
Dimensões da plataforma alargada	1400x768mm
Tempo de elevação (sem carga)	24s
Tempo de descida (sem carga)	140s
Incluindo o suporte	Si/Yes
Peso	418,00Kg
Dimensões (CxLxA)	1840x770x650mm

54564 5.511,00€



ELEVADOR PARA MONTAGEM DE BATERIAS EM VEÍCULOS ELÉCTRICOS SEM SUPORTES 1200KG



Capacidade	1200Kg
Altura máxima de elevação	1840mm
Altura mínima de elevação	650mm
Dimensões da plataforma	1290x768mm
Dimensões da plataforma alargada	1400x768mm
Tempo de elevação (sem carga)	24s
Tempo de descida (sem carga)	140s
Incluindo o suporte	No
Peso	418,00Kg
Dimensões (CxLxA)	1840x770x650mm



DISTÂNCIA DE SEGURANÇA

REF.	DESCRIÇÃO					€
53940	POSTE DE PLÁSTICO PARA CORRENTE - AMARELO / PRETO	0.55	-	6	90	15,40€
54326	CORRENTE DE PVC - 7M - AMARELO/PRETO	0.30	-	20	600	8,40€
53987	FITA DE SINAL AMARELO/PRETO - 200M	0.59	-	40	560	9,90€
53942	ELO DE FECHAR PRETO	0.01	50	5000	75000	0,50€
54322	CONJUNTO DE 2 SINAIS DE AVISO DE ALTA TENSÃO	0.05	25	100	-	19,00€



CARROS DE FERRAMENTAS COM 7 GAVETAS

ESPECIAL VEÍCULOS ELÉTRICOS

REF.	GAVETAS	COR	EQUIPADO	PEÇAS	MATERIAL					€
54236	7		Com ferramentas	23	Aço	67.70	-	1	4	1.856,00€
54234	7		Com ferramentas	23	Aço	67.70	-	1	4	1.856,00€
54235	7		Com ferramentas	23	Aço	67.70	-	1	4	1.856,00€
54233	7		Com ferramentas	23	Aço	67.70	-	1	4	1.856,00€

CONTÉM

REF.					€		
52162	A	1	0.17	6	72	576	38,00€
53940	B	4	0.55	-	6	90	15,40€
54326	C	4	0.30	-	20	600	8,40€
53942	D	8	0.01	50	5000	75000	0,50€
54093	E	1	2.88	-	4	80	441,00€
54114	F	1	1.48	-	10	100	248,00€
54129	G	1	2.10	-	5	200	110,00€
54130	H	1	0.35	-	1	100	58,00€
54132	I	1	0.70	-	1	72	190,00€
54241	J	1	1.10	-	1	50	120,00€



ACESSÓRIOS DE OFICINA

ENROLADOR DE MANGUEIRA

406

ESCADAS

407

CARRINHOS E PLATAFORMAS

409



CARRETEL DE CABO ELÉCTRICO

REF.		m	V	W	IP					€
53586		21m	320V	1000-3000W	IP44	8.35	-	2	36	168,00€
53585		21m	320V	1000-3000W	IP44	8.35	-	2	36	168,00€
53584		12m	320V	1000-3000W	IP44	5.10	-	4	48	119,00€
53526		12m	320V	1000-3000W	IP44	5.15	-	4	48	119,00€



CARRETEL DE MANGUEIRA DE AR

REF.		m	"	PSI	BAR						€
53582		22m	3/8"	300 PSI	20 BAR	9.5mm	10.40	-	1	14	174,00€
53583		22m	3/8"	300 PSI	20 BAR	9.5mm	10.75	-	1	14	174,00€
53532		13m	3/8"	300 PSI	20 BAR	9.5mm	6.60	-	2	30	119,00€
53581		13m	3/8"	300 PSI	20 BAR	9.5mm	6.70	-	2	30	119,00€
53881		11m	1/4"	300 PSI	20 BAR	9.5mm	4.50	-	4	48	79,00€
53882		11m	1/4"	300 PSI	20 BAR	9.5mm	4.50	-	4	48	79,00€



53872

118,00€

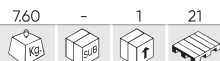

CARRETEL DE MANGUEIRA DE ÁGUA BOCA DE 15M

Comprimento do tubo	15m	Material	PVC
Pressão do trabalho	8BAR	Peso	7,50Kg
Conectores	3/4"	Dimensões (CxLxA)	440x230x410mm
Diâmetro	15,8mm		



REPOSIÇÕES
DISPONÍVEIS



50797

490,00€

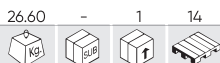

CARRETEL DE MANGUEIRA PARA ÓLEO BOCA DE 1/2" 15M

Comprimento do tubo	15m	Material	S
pressão de ruptura	169BAR	Peso	26,60Kg
Conectores	1/2"	Dimensões (CxLxA)	640x255x630mm
Diâmetro	12,7mm		



51033

98,00€



EXTENÇÃO MANUAL DE CABO ELÉCTRICO 25M

Tensão	300V
Potência	1.110-3.200W
Comprimento do cabo	25m
Proteção IP	IP20
Cabo	H05W-F 3X1,5 mm2 (PVC)
Peso	3,86Kg
Dimensões (CxLxA)	320x230x155mm







EXTENSÃO DE CORRENTE ELÉTRICA

REF.	m					€
53166	3m	0.45	5	30	600	11,30€
53167	5m	0.65	5	20	600	13,90€
53168	10m	1.20	-	10	300	26,00€



ESCADA TELESCÓPICA

CUMPRE COM: EN 131

REF.	DESCRIÇÃO	Max.	Min.					€
51982	ESCADA TELESCÓPICA 6 DEGRAUS 2M	2000mm	730mm	5.51	-	1	34	120,00€
51983	ESCADA TELESCÓPICA 10 PASOS 3.2M	3200mm	930mm	9.41	-	1	34	185,00€
51984	ESCADA TELESCÓPICA 12 PASOS 3.8M	3800mm	1020mm	9.78	-	1	21	190,00€



51982



51983



51984



52149 230,00€

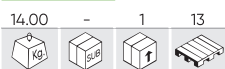

ESCADA TELESCÓPICA EM "V" DOBRÁVEL



Capacidade	150Kg
Altura mínima	835mm
Altura máxima	3800mm
Conformidade com a diretiva europeia	EN131
Material	Al, PT
Peso	14,00Kg
Dimensões (CxLxA)	160x490x835mm

54176 188,00€



ESCADA MULTIFUNÇÕES



REPOSIÇÕES DISPONÍVEIS

Capacidade	150Kg
Altura mínima	1030mm
Altura máxima	3700mm
Conformidade com a diretiva europeia	EN131
Material	Al
Peso	16,00Kg
Dimensões (CxLxA)	1235x640x1850mm

54681



ESCADA DE 3 DEGRAUS

Capacidade	150Kg
Medidas das bandejas	380x26mm
Distância entre tabuleiros	240mm
Conformidade com a diretiva europeia	EN14183: 2003
Peso	6,00Kg
Altura	720mm
Dimensões (CxLxA)	475x650x1150mm
Dimensões da plataforma alargada	475x650x1250mm



74,50€

50517



ESCADOTE DE ALUMÍNIO DE 4 DEGRAUS

Capacidade	150Kg
Altura máxima	1300mm
Material	Al
Conformidade com a diretiva europeia	EN131
Peso	4,00Kg
Dimensões (CxLxA)	110x420x1300mm



129,00€

50518



ESCADOTE DE ALUMÍNIO DE 6 DEGRAUS

Capacidade	150Kg
Altura máxima	1910mm
Material	Al
Conformidade com a diretiva europeia	EN131
Peso	5,32Kg
Dimensões (CxLxA)	120x480x1910mm



169,00€

52230



PLATAFORMA DE ALUMÍNIO TELESCÓPICA



REPOSIÇÕES DISPONÍVEIS

Capacidade	150Kg
Dimensões dobradas	300x1090x900mm
Comprimento mínimo	1090mm
Comprimento máximo	1750mm
Altura mínima	250mm

Altura máxima	900mm
Material	Al
Conformidade com a diretiva europeia	EN131
Peso	16,65Kg
Dimensões (CxLxA)	300x1750x900mm

398,00€

50913

195,00€

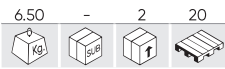

PLATAFORMA DE ALUMÍNIO GRANDE

Capacidade	100Kg
Material	Al
Conformidade com a diretiva europeia	EN131
Dimensões (CxLxA)	1400x300x800mm
Peso	6,50Kg
Dimensões dobradas	1400x300x14mm



50656

290,00€

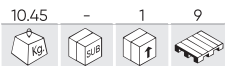

JOGO 2 PLATAFORMAS DE ALUMÍNIO

Capacidade	100Kg
Dimensões da plataforma grande (CxLxA)	1300x300x550mm
Dimensões da plataforma grande dobrada (CxLxA)	1300x300x140mm
Dimensões da plataforma pequena (CxLxA)	1000x300x300mm
Dimensões da plataforma pequena dobrada (CxLxA)	1000x300x140mm
Material	Al
Contém	11897, 15552
Conformidade com a diretiva europeia	EN131
Peso	10,45Kg



REPOSIÇÕES DISPONÍVEIS

52202

88,00€

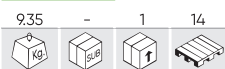

CARRINHO DE MÃO 2 RODAS BASICO DE AÇO CAP.200KG



REPOSIÇÕES DISPONÍVEIS



Capacidade	200Kg
Material	S
Peso	9,35Kg
Dimensões (CxLxA)	500x450x1100mm

50924

342,00€



CARRO PORTA BIDÕES 200KG



Capacidade	200Kg
Material	Fe
Peso	31,00Kg
Dimensões (CxLxA)	990x790x830mm

52200

88,00€

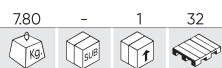

CARRINHO PLATAFORMA DE AÇO 150KG



Capacidade	150Kg
Material	S
Peso	7,80Kg
Dimensões (CxLxA)	735x480x830mm
Dimensões dobradas	735x480x230mm

54305

233,00€

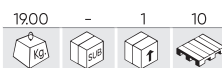

CARRO DOBRÁVEL PLATAFORMA ALUMINIO 300KG



Capacidade	300Kg
Material	Al
Peso	19,00Kg
Dimensões (CxLxA)	900x610x895mm
Dimensões dobradas	900x610x330mm

54308

89,00€

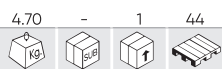

CARRINHO DE MÃO DOBRÁVEL ALUMINIO 90KG



Capacidade	90Kg
Material	Al
Peso	4,70Kg
Dimensões (CxLxA)	440x485x1150mm
Dimensões dobradas	50x485x850mm

54309

71,00€

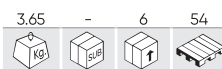

CARRINHO DE MÃO DOBRÁVEL SOBE ESCADAS 75KG



Capacidade	75Kg
Material	Al
Peso	3,65Kg
Dimensões (CxLxA)	270x390x1000mm
Dimensões dobradas	83x390x645mm

54310

59,00€



CARRINHO DE MÃO DOBRÁVEL ALUMINIO 75KG



Capacidade	75Kg
Material	Al
Peso	3,00Kg
Dimensões (CxLxA)	270x390x1000mm
Dimensões dobradas	55x390x640mm

54306

219,50€

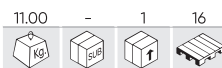

CARRINHO DE MÃO DOBRÁVEL ALUMINIO 250KG



Capacidade	250Kg
Material	Al
Peso	11,00Kg
Dimensões (CxLxA)	610x620x1200mm
Dimensões dobradas	80x590x1000mm

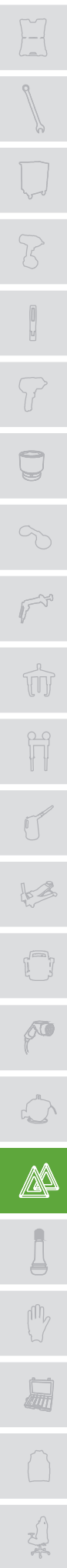

53778 4,50€

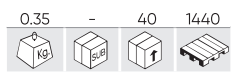

TRIÂNGULO DE SINALIZAÇÃO HOMOLOGADO 27R032736



Peças	1
Material	ABS, PPMA, PVC, PP
Normas	E4 27R-032736
Dimensões dobradas	440x25x45mm
Peso	0,35Kg
Dimensões (CxLxA)	440x405x385mm

52795 5,80€

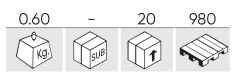

TRIÂNGULO DE SINALIZAÇÃO HOMOLOGADO 27R032738



Peças	1
Material	ABS, PPMA, PVC, PP
Normas	E4 27R-032738
Peso	0,50Kg
Dimensões (CxLxA)	440x405x385mm

54298 8,40€



2 TRIÂNGULO DE SINALIZAÇÃO HOMOLOGADO 27R032736



Peças	2
Material	ABS, PPMA, PVC, PP
Normas	E4 27R-032736
Dimensões dobradas	440x25x45mm
Peso	0,74Kg
Dimensões (CxLxA)	440x405x385mm

KAMIZELKA ODBLASKOWA

CUMPRE COM: EN ISO20471:2023+A1:2016

REF.	DESCRIÇÃO					€
50654	COLETE COR-DE-LARANJA REFLECTOR HOMOLOGADO	0.13	-	100	2600	4,00€
50966	COLETE AMARELO REFLECTOR HOMOL.	0.12	-	100	2600	4,00€
50966C	COLETE AMARELO REFLECTOR HOMOL.	0.12	-	100	2600	4,00€



50654



50966



50966C

FITA REFLEXIVA DE MARCAÇÃO PARA VEÍCULOS DE MERCADORIAS

CUMPRE COM: CEPE/ONU 104R

REF.					€	
51935		1.04	-	10	280	135,00€
51936		1.04	-	10	480	135,00€
51937		1.02	-	10	280	135,00€



53636 22,00€

0.87 5 25 700



CHAPA DE SINALIZAÇÃO V-20 "CARGA SUPERDIMENSIONADA" - PP



Material	PP
Normas	V20
Peso	0,87Kg
Dimensões (CxLxA)	500x500mm

53507 27,00€

0.75 5 25 800



CHAPA DE SINALIZAÇÃO V-20 "CARGA SUPERDIMENSIONADA"



Material	PMMA, Al
Normas	V20
Peso	0,87Kg
Dimensões (CxLxA)	500x500mm

54735 CONSULTAR

0.30 20 80 -



SINALIZADOR DE EMERGÊNCIA GEOLOCALIZÁVEL V16

Brilho	40-80cd
Proteção IP	IP54
Frequência	0,82Hz
Temperatura de trabalho	-20~50°C
Rotativo	-8~8°
Resistência	180Pa
Temperatura de cor do LED	1700±200 Kelvin
Certificação	V16
Material	ABS/PC
Método de carregamento	Pila/Battery AA (x4)
Magnetizado	Si/ Yes
Inclui	GPS ~ x4 Batteries
Peso	0,70Kg
Dimensões (CxLxA)	125x112mm

Luz de emergência para sinalizar qualquer veículo em qualquer tipo de situação de emergência, muito prático e fácil de usar.

- Obligatoriu în Spania începând cu 1 ianuarie 2026.
- Conectat la DGT 3.0. Fără conexiune în afacerea Spaniei.



V16

GPS

EM EXPOSITOR DE 20 UDS

KIT EMERGÊNCIA

Ver o preço para as quantidades desenho personalizável, pede cotação. Serigrafia e fotolito não inclui.

ESTOJO CON RIBETE

REF.							€
51693	●	550x90x130mm	0.12	-	100	1200	3,55€
51694	●	550x90x130mm	0.14	-	100	1200	3,55€
51695	●	550x90x130mm	0.11	-	100	1800	3,55€



ESTOJO MINI

REF.							€
53621	●	550x150mm	0.05	-	100	3200	2,50€
53622	●	550x150mm	0.05	-	100	3200	2,50€
53623	●	550x150mm	0.05	-	100	3200	2,50€



SACO PRETO COM RIBETE

REF.							€
11328	●	557x110x70mm	0.12	-	100	1200	4,00€



ESTOJO PRETO DE NYLON

REF.							€
15619	●	330x100x80mm	0.09	-	100	1500	4,00€

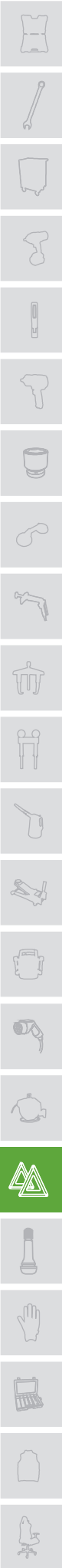

KIT EMERGÊNCIA ESTOJO CON RIBETE

REF.		△					€
53088	●	x1	0.59	-	10	200	11,50€
53089	●	x1	0.61	-	10	200	11,50€
53090	●	x1	0.59	-	10	200	11,50€



KIT EMERGÊNCIA ESTOJO MINI

REF.		△					€
53092	●	x1	0.52	-	10	200	10,20€
53093	●	x1	0.52	-	10	200	10,20€
53094	●	x1	0.52	-	10	200	10,20€



KIT EMERGÊNCIA

REF.		△						€
52773	●	x2	MK H4	1.01	-	10	200	17,80€
52781	●	x2	MK H4	1.14	-	10	200	17,80€
52774	●	x2	MK H7	0.99	-	10	200	17,80€
52778	●	x2	MK H7	0.99	-	10	200	17,80€
52775	●	x2	MK H7+H1	1.01	-	10	200	18,10€
52783	●	x2	MK H7+H1	1.01	-	10	200	18,10€



KIT EMERGÊNCIA ESTOJO BORDA

REF.		△					€
53178	●	x1	0.64	-	10	200	12,20€
53179	●	x1	0.65	-	10	200	12,20€
53180	●	x1	0.63	-	10	200	12,20€
53182	●	x2	0.99	-	10	200	15,80€
53183	●	x2	0.99	-	10	200	15,80€
53184	●	x2	0.98	-	10	200	15,80€



54534

0.37	-	10	200

KIT DE EMERGÊNCIA (SINALIZADOR E COLETE)



CONSULTAR

MINI ESTOJO DE LÂMPADA

REF.								€
51613	12V	H1	0.90	10	100	1500		3,20€
51615	12V	H9	0.09	10	100	1500		6,50€
51612	12V	H11	0.09	10	100	1500		6,50€
50523	12V	HB3	0.09	10	100	1500		5,10€
50524	12V	HB4	0.09	10	100	1500		5,10€
50915	12V	H7+H1	0.10	10	100	1800		4,60€
51614	12V	H4	0.10	10	100	1800		3,95€
50431	12V	H7	0.08	10	100	1800		3,80€
52047	24V	H4	0.09	10	100	1500		3,65€
52048	24V	H7	0.10	10	100	1500		4,30€



LÂMPADAS OBN

REF.								€
52365	H7	12V	55W	0.02	10	200	9000	2,46€
52364	H4	12V	60-55W	0.02	10	200	4400	3,10€
52362	H1	12V	55W	0.01	10	200	14400	1,35€
52363	H3	12V	55W	0.02	10	200	14400	1,35€
53203	BA15S	12V	21W	0.01	10	200	-	0,50€
52369	2 POLOS	12V	21-5W	0.01	10	1000	18000	1,30€
52368	T20A	12V	21W	0.01	10	1000	18000	1,25€
53007	R5W	5V	12W	0.05	10	200	1500	0,45€
52862	WEDGE T20	12V	21W	0.01	10	1000	1500	1,25€
52370	T20	12V	21W	0.01	10	1000	18000	1,25€
52864	T20	12V	21-5W	0.01	10	1000	1500	1,30€
52865	T13	12V	10W	0.01	10	2000	-	0,50€
52866	T15	12V	18W	0.01	10	5000	256000	0,28€



50551

350,00€

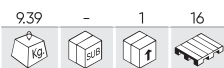

ARMÁRIO DE LÂMPADAS PARA TURISMOS

Lâmpadas Halógenas

x10	H1 55 W P14.5s
x4	H2 55 W X511
x4	H3 55 W PK22s
x10	H4 60/55 W P43t
x10	H7 55 W PX26d
x4	HB3 65 W P20d
x4	HB4 55 W P20d
x4	H9 65 W PGJ19-5
x4	H11 65 W PGJ19-2
Foco Europeu	
x20	T5 1,2 W W2.1x4,6d
x12	T10 5 W W2.1x9,6d
x12	T10 3 W W2.1x9,6d
x10	T13 10 W W2.1x9,6d

x10	T15 18 W W2.1x9,6d
x10	T20 21 W W5x16d
x10	T20A 21 W W5x16d Ambar
x10	T20 21/5 W W5x16d
Stop de 1 Polo	
x30	P21W 21 W BA15s
x10	P21WA 21 W BA15s Ambar
x10	PY21W 21 W BAU15s Com desc.
Stop de 2 Polos	
x40	R21/5 W 21/5 W BAY15d PLAFONIER
x22	C5W 5 W SV8.5 11x38
Lâmpadas Piloto	
x30	R5W 5 W BA15s
x30	R10W 10 W BA15s

Lâmpadas indicadoras

x22	T4W 4 W BA9s
------------	--------------



54042

13,00€

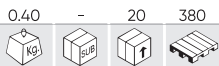

BOLSA DE PRIMEIROS SOCORROS DIN13164:2022

- x1 Fita adesiva DIN13019-A 5x2,5
- x4 Fitas adesivas din 13019-e 10x6
- x2 Adesivos elásticos para os dedos 4x7 cm
- x2 2 Adesivos elásticos para os dedos 12x2 cm
- x2 Tiras de fita adesiva à prova d'água 1,9x7,2 cm
- x4 Tiras de fita adesivas à prova d'água 2,5x7,2 cm
- x1 Bandagem estéril DIN 13151-K 6x8 cm
- x2 Bandagens estéreis DIN 13151-M 8x10 cm
- x1 Bandagem estéril DIN 13151-G 10x12 cm
- x1 Bandagem de primeiros socorros DIN 13152-BR 60x40 cm
- x1 Bandagem de primeiros socorros DIN 13152-A 60x80 cm
- x2 Bandagens estéreis DIN 61634FB6 6 cm x 400 cm
- x3 Bandagens estéreis DIN 61634FB6 8 cm x 400 cm
- x1 Manta de resgate 160x210 cm
- x6 Compressas estéreis para feridas 10x10 cm
- x2 Bandagens triangulares DIN 13168-D
- x1 Tesoura DIN 58279-A145 145 cm
- x4 Luvas descartáveis din en 455-1
- x2 Lenços umedecidos para limpar pele

54042N

13,00€

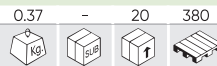

- x1 Lista de conteúdos
- x1 Guia de primeiros socorros
- x2 Máscaras cirúrgicas DIN EN 14683

51246



BOLSA DE PRIMEROS SOCORROS

- x1 Folha de primeiros socorros
- x1 Tesoura
- x1 Par de luvas
- x2 Toalhetas de álcool
- x2 Pensos para cortes
- x1 25gr. De algodão

6,40€



- x1 Pensos para queimaduras
- x1 Liga
- x1 Rolo adesivo

54072

38,50€

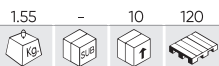

MALETA DE PRIMEIROS SOCORROS DIN13157

- x1 Gesso adesivo 5 x 25 - DIN13019-A
- x1 Conjunto de bandagens adesivas 10 x 6 cm (8 unid.) - DIN13019-E
- x6 Remedos de dedo 4 x 6,5 cm
- x6 Remedos de dedo 120 x 20 mm
- x6 Remedos de dedo 7,2 x 1,9 cm
- x12 Remedos de dedo 25 x 72 mm
- x1 Conjunto de bandagens de primeiros socorros 6 x 8 cm - DIN13151-K
- x3 Conjuntos de bandagens de primeiros socorros 8 x 10 cm - DIN13151-M
- x1 Conjunto de ataduras de primeiros socorros 10 x 12 cm - DIN13151-G
- x1 Compressa estéril (curativo de tratamento de queimadura) 60 x 80 cm - DIN13152-A
- x3 Curativos esterilizados (compressas) 100 x 100 mm, 2 unidades / bolsa - DIN58953-2
- x2 Tapa-olhos - 55 mm x 75 mm 1,5 g
- x1 Compressa fria para tratamento de emergência, min. 200 Cm2
- x1 Manta de primeiros socorros, 160 x 210 cm, 12 microns
- x2 Bandagens elásticas (gaze), 6 cm por 400 cm - DIN61634 FB6
- x2 2 Bandagens elásticas (gaze), 8 cm por 400 cm - DIN61634 FB8
- x2 Bandagens triangulares 96x96x136 cm - DIN13168-D
- x1 Tesoura de metal 190 mm - DIN58279-B190
- x2 Sacos de plástico para lixo, 300 x 400 mm, 45 microns
- x5 Materiais não tecidos 20 x 30 cm, min. 15 G/h9m2
- x1 Luvas descartáveis de pvc l-aq1.5 (Conjunto de 4) - DIN EN 455-1



- x1 Livro de informações
- x2 Máscaras cirúrgicas DIN EN 14683
- x4 Toalhetes de limpeza de pele saudáveis

50644

11,60€

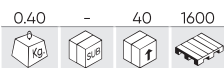

CINTO DE SEGURANÇA DE 2 PONTOS PARA AUTOCARROS



Material	PL
Normas	E4-16R-0436213
Comprimento	1250mm
Peso	0,40Kg

50717

21,90€

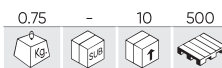

CINTO DE SEGURANÇA DE 2 PONTOS ENROLÁVEL PARA AUTOCARROS



Material	PL
Normas	E4-16R-0436232
Comprimento	1330mm
Peso	0,75Kg

51266

28,00€

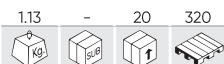

CINTO DE SEGURANÇA DE 3 PONTOS ENROLÁVEL PARA AUTOCARROS



Material	PL
Normas	E4-16R-0436232
Comprimento	2900mm
Peso	1,13Kg

52259

3,75€

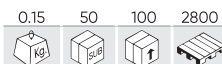

MARTELO DE JANELA DO CARRO COM SUPORTE E CORTADOR DE CINTOS DE SEGURANÇA



Largura	750mm
Altura	130mm
Peso	0,15Kg

51861

199,00€



MÁQUINA PNEUMÁTICA P/MONTAR FOLES DE TRANSMISSÕES



Entrada de ar	1/4"
Pressão do trabalho	9BAR
Material	Aluminio/Aluminum
Abertura	20-100mm
Peso	4,00Kg
Dimensões (CxLxA)	200x200x450mm

52829

19,00€



FERRAMENTA P/MONTAR FOLES DE TRANSMISSÕES



Diâmetro exterior	100mm
Diâmetro interior	95mm
Peso	0,45Kg
Comprimento	410mm

ABRAÇADEIRAS

REF.	mm					€
11890	50-125mm	0.01	100	1000	8000	0,55€
11891	15-45mm	0.004	100	5000	90000	0,50€
52633	15-45mm / 50-125mm	0.02	100	800	8000	1,00€



11891

11890

52633

KIT DE FOLE DE TRANSMISSÕES

REF.						€
51703	PARA CARRINHAS	0.28	-	20	320	10,50€
51705	PARA TURISMO	0.23	-	20	400	8,45€



53693

521,00€

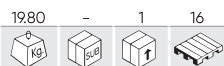

KIT DE 100 FOLE DE TRANSMISSÕES



REF.							€
52633	A	100PCS	0.02	100	800	8000	1,00€
13738	B	100PCS	0.08	-	150	1800	3,50€
13879	C	100PCS	0.09	-	150	5250	2,40€

53695

504,00€

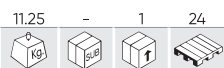

KIT DE 80 FOLE DE TRANSMISSÃO UNIVERSAL



REF.							€
52633	A	80PCS	0.02	100	800	8000	1,00€
13740	B	80PCS	0.10	-	72	-	5,50€
13880	C	80PCS	0.01	-	600	21000	0,47€

52644

8,80€

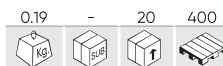

KIT DE FOLE DE TRANSMISSÕES UNIVERSAL



REF.							€
11922	A	1PCS	0.10	-	80	-	5,70€
13880	B	1PCS	0.01	-	600	21000	0,47€
52633	C	1PCS	0.02	100	800	8000	1,00€

53698

717,00€



KIT DE 100 FOLE DE TRANSMISSÃO PARA FURGONETA



REF.							€
52633	A	100PCS	0.02	100	800	8000	1,00€
13739	B	100PCS	0.13	-	100	1600	5,50€
13880	C	100PCS	0.01	-	600	21000	0,47€

SERIE124

710,00€

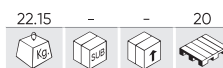

SÉRIE PROMOCIONAL ESPECIAL KIT FOLE



REF.							€
51861	A	1PCS	4.00	-	2	32	199,00€
52633	B	100PCS	0.02	100	800	8000	5,50€
13738	C	100PCS	0.08	-	150	1800	3,50€
13879	D	100PCS	0.09	-	150	5250	2,40€

50585

18,50€



TAPETE DE BORRACHA UNIVERSAL - REVERSIBLE



Peças	4
Dimensões frontais	670x460mm
Dimensões traseiras	460x330mm
Material	Goma/Rubber
Compatível com	Multimarca/Multi-brand
Peso	2,86Kg

53241

9,00€

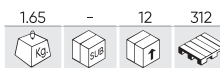

TAPETE DE BORRACHA UNIVERSAL



Peças	4
Dimensões frontais	635x445mm
Dimensões traseiras	330x430mm
Material	Goma/Rubber
Compatível com	Multimarca/Multi-brand
Peso	1,65Kg

52534

15,00€



TAPETE DE TELA UNIVERSAL COM TALONERA BORRACHA



Peças	4
Dimensões frontais	425x660mm
Dimensões traseiras	295x425mm
Material	Moqueta/Carpet, Goma/Rubber
Compatível com	Multimarca/ Multi-brand
Peso	1,55Kg

52535

16,50€



TAPETE DE TELA UNIVERSAL + TALONERA TELA



Peças	4
Dimensões frontais	425x660mm
Dimensões traseiras	295x425mm
Material	Moqueta/Carpet, Goma/Rubber
Compatível com	Multimarca/Multi-brand
Peso	1,55Kg

52530

14,00€



TAPETE DE TELA UNIVERSAL



Peças	4
Dimensões frontais	390mm
Dimensões traseiras	365x480mm
Material	Moqueta/Carpet, Goma/Rubber
Compatível com	Multimarca/Multi-brand
Peso	2,00Kg





LIMPADOR DE PARA-BRISA

REF.	"	mm					€
53745	11"	280mm	0.20	10	50	800	6,80€
53746	12"	310mm	0.20	10	50	800	6,90€
53747	13"	330mm	0.20	10	50	900	6,90€
53748	14"	350mm	0.20	10	50	800	7,00€
53749	15"	380mm	0.20	10	50	900	7,00€
53750	16"	410mm	0.20	10	50	800	7,10€
53751	17"	430mm	0.20	10	50	900	7,20€
53752	18"	460mm	0.25	10	50	800	7,60€
53753	19"	480mm	0.25	10	50	800	7,90€
53754	20"	510mm	0.25	10	50	900	8,00€
53755	21"	530mm	0.25	10	50	600	8,00€
53756	22"	560mm	0.25	10	50	600	8,20€
53757	24"	610mm	0.25	10	50	600	8,70€
53758	26"	650mm	0.30	10	50	600	9,00€
53759	28"	700mm	0.30	10	50	550	9,20€
53760	30"	750mm	0.30	10	50	500	10,30€

11 ADAPTADORES DIFERENTES:
para vários aplicativos



JBMWEXP

26,00€

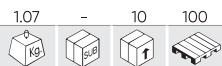

EXPOSITOR ESCOVAS DE LIMPA VIDROS OBN

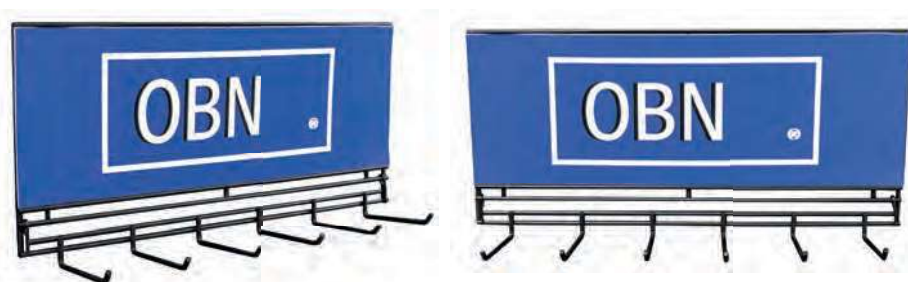

53919

81,00€

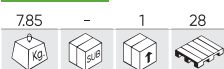

SUPOORTE DE REPARO DE BICICLETAS



Material	S, ABS, NY
Capacidade	30Kg
Altura máxima	1880mm
Altura mínima	1070mm
Peso	7,85Kg

54166

33,00€



BOMBA DE PÉ PARA PNEUS DE BICICLETA



Material	Al
Pressão do trabalho	160PSI
Compatível com	Válvulas/Valves Schrader, Presta, Dunlop
Medidas	32x530mm
Peso	0,90Kg

54170

17,70€

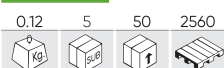

BOMBA DE MÃO PORTÁTIL PARA BICICLETA



Material	Al
Pressão do trabalho	100PSI
Compatível com	Válvulas/Valves Presta, Schrader
Medidas	21x195mm
Peso	0,12Kg

54074

19,70€



FERRAMENTA MULTIFUNCCIONAL DE REPARO DE BICICLETAS



x1 Ponta cruzada	x1 Pino de desmontagem
x7 Soquetes hex	x1 Chave inglesa
x1 Chave de fenda	x1 Chave de roda dentada T25
x1 Ferramenta de montagem de cadeia	x1 Gancho de cadeia
x2 Alavancas para pneus	

54073

70,00€

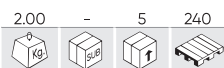

CONJUNTO DE FERRAMENTAS PARA BICICLETA - 20 PÇS



Peças	20
Dimensões (CxLxA)	220x220x70mm
Peso	2,00Kg

54169

15,20€

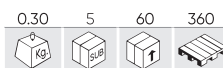

CADEADO DE COMBINAÇÃO PARA BICICLETA



Material	S, ABS, PVC
Medidas	10x1000mm
Peso	0,30Kg

51858

15,00€

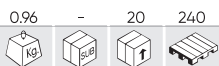

PÁ DOBRÁVEL



Material	ME
Altura máxima	600mm
Altura mínima	240mm
Peso	0,96Kg

53033

22,00€

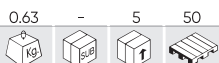

PÁ COM CABO EXTENSÍVEL



Material	Al
Altura máxima	119mm
Altura mínima	85mm
Peso	0,63Kg

53964

9,65€

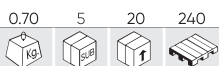

CORDA MULTIUSOS 30M 1/4"



Material	PP
Medida	30m
Diâmetro	1/4"
Carga máxima	550,000Kg
Peso	0,70Kg

53965

25,80€

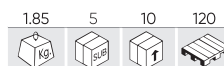

CORDA MULTIUSOS 30M 1/2"



Material	PP
Medida	30m
Diâmetro	1/2"
Carga máxima	1200,000Kg
Peso	1,85Kg

51412

2,45€

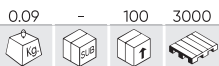

PORTA-PLACA DE MATRICULA ANÔNIMA

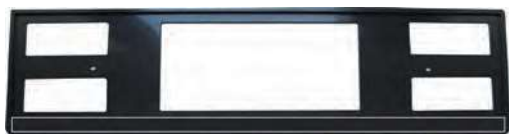

Material	PVC
Dimensões (CxLxA)	532x137mm
Peso	0,09Kg

51697

0,80€

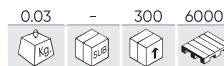

ESPÁTULA TIRA GELO



Dimensões (CxLxA)	180x85x30mm
Peso	0,03Kg



50526

5,20€

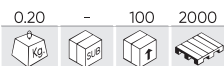

GUARDA-CHUVA DOBRÁVEL



Material	PL, ST, TY
Peso	0,20Kg
Comprimento	240mm

50525

1,00€



CAPA IMPERMEÁVEL



Material	LDPE, PE
Peso	0,05Kg
Dimensões (CxAl)	1010x1270mm

51925

1,00€

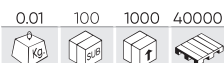

TESOURAS MINI



Peças	1
Tipo	Mini
Comprimento	90mm
Peso	0,01Kg

53221

4,75€

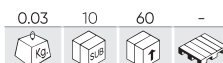

JOGO DE 3 CAMURÇAS DE MICROFIBRAS



Peças	3
Cor	Verde/Green
Material	PL
Medida	360x360mm

52618

29,00€



SET ORGANIZADOR DE MALETERO MULTIFUNCIONAL

Cofre flexível com tampa	300x490mm (37L)
Bidon circular com tampa	180x230mm
Suporte porta objectos	90x260mm
Bandeja rígida	300x75mm



53561

28,00€



CALÇO DE RODA

Peças	1
Material	S, PP
Capacidade	30T
Peso	1,66Kg
Dimensões (CxLxA)	470x200x300mm



53508

14,00€

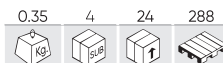

CALÇOS DE RODA

Peças	2
Material	S, PP
Capacidade	1T
Peso	0,35Kg
Dimensões (CxLxA)	220x90x90mm



51863

64,00€

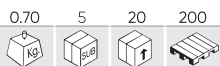

SENSOR DE ESTACIONAMENTO COM MEDIDOR DE APROXIMAÇÃO VISUAL E ACÚSTICO

Tensão nominal	12V
Potência	3,6W
Temperatura de trabalho	-20°C/+70°C
Distância de detecção	0,3-2,0m
Ângulo de detecção	H-60°, V-60°
Quantidade de sensores	4
Indicadores	1
Peso	0,70Kg



51973

53,00€

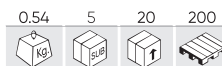

SENSOR DE ESTACIONAMENTO COM MEDIDOR DE DISTÂNCIA ACÚSTICO

Tensão nominal	12V
Potência	3,6W
Temperatura de trabalho	-20°C/+70°C
Distância de detecção	0,3-2,0m
Ângulo de detecção	H-60°, V-60°
Quantidade de sensores	4
Indicadores	0
Peso	0,54Kg



TUBOS FLEXÍVEL INNERBRAID



REF.	DESCRIÇÃO	0.35	-	25	1500	€
51706	Ø 25mmL x 300mmL	0.35	-	25	1500	22,80€
51707	Ø 45mmL x 100mmL	0.27	-	25	1200	9,05€
51708	Ø 45mmL x 150mmL	0.38	-	25	-	14,20€
51709	Ø 45mmL x 200mmL	0.50	-	25	-	14,70€
51710	Ø 45mmL x 250mmL	0.65	-	25	600	17,80€
51711	Ø 45mmL x 300mmL	0.71	-	25	-	21,20€
51712	Ø 50mmL x 100mmL	0.30	-	25	-	8,65€
51713	Ø 50mmL x 150mmL	0.45	-	25	-	13,10€
51714	Ø 50mmL x 200mmL	0.56	-	25	750	15,80€
51715	Ø 50mmL x 250mmL	0.70	-	25	-	20,30€
51716	Ø 50mmL x 300mmL	0.83	-	25	450	23,60€

REF.	DESCRIÇÃO	0.35	-	25	-	€
51717	Ø 55mmL x 100mmL	0.35	-	25	-	11,20€
51718	Ø 55mmL x 150mmL	0.50	-	25	-	14,80€
51719	Ø 55mmL x 200mmL	0.65	-	25	-	22,00€
51720	Ø 55mmL x 250mmL	0.85	-	25	350	23,50€
51721	Ø 55mmL x 300mmL	1.00	-	25	375	25,00€
51722	Ø 60mmL x 100mmL	0.36	-	25	750	13,10€
51723	Ø 60mmL x 150mmL	0.50	-	25	450	18,70€
51724	Ø 60mmL x 200mmL	0.66	-	25	400	24,40€
51725	Ø 60mmL x 250mmL	0.83	-	25	-	28,30€
51726	Ø 60mmL x 300mmL	0.96	-	25	250	31,40€
51727	Ø 60mmL x 400mmL	1.62	-	25	200	49,00€

DISPONÍVEL EM CAIXA INDIVIDUAL

ACESSÓRIOS DE PNEUS

CONTRAPESOS

426

REPARAÇÃO DE FUROS

428

VÁLVULAS DE PNEUS

429

REMOÇÃO E INSTALAÇÃO

430



51908

44,00€

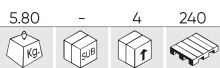

DISPENSADOR DE CONTRAPESOS AUTO-ADESIVOS PASTILHAS DE FERRO 5GRX1.000



Peças	1000
Material	Hierro/Iron
Gramas	5
Peso	5,80Kg
Dimensões (CxLxA)	35x295x295mm

53256

34,00€



DISPENSADOR DE CONTRAPESOS AUTO-ADESIVOS PASTILHAS DE FERRO 5G X 1.000



Peças	1000
Material	Hierro/Iron
Gramas	5
Peso	5,30Kg
Dimensões (CxLxA)	40x295x295mm

CONTRAPESO DE CLIP ADESIVA

REF.	DESCRIÇÃO					€
50600	CONTRAPESO DE CLIP ADESIVA DE AÇO EM PASTILHA DE 45GR	0.05	100	400	36000	0,60€
50601	CONTRAPESO DE CLIP ADESIVA DE FERRO EM PASTILHA DE 45GR	0.05	100	400	48000	0,29€



50600



50601

CONTRAPESO DE CLIP ADESIVA

REF.	DESCRIÇÃO					€
52665	CONTRAPESO DE CLIP ADESIVA DE FERRO EM PASTILHAS 60GR (12X5GR.)	0.06	100	400	20000	0,37€
52666	CONTRAPESO DE CLIP ADESIVA FERRO EM PASTILHA DE 60GR (4X10GR., 4X5GR.)	0.06	100	400	20000	0,36€



52665



52666

CONTRAPESO UNIVERSAL CAMINHÃO

REF.	g					€
52667	50g	0.05	50	400	25600	0,82€
52668	100g	0.10	25	200	12800	1,60€
52669	150g	0.15	20	160	10240	2,40€
52670	200g	0.20	10	80	5120	3,15€
52671	250g	0.25	10	80	5120	3,95€
52672	300g	0.30	10	80	5120	4,70€



52667



52668



52669



52670



52671



52672

53864

138,00€

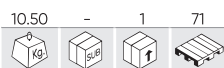

CAIXA DE CONTRAPESOS SURTIDO

CONTRAPESOS DE ZINC COM GRAPA

PARA JANTE UNIVERSAL			PARA JANTE ALUMÍNIO		
54656	20 PCS	5g	54666	20 PCS	5g
54657	20 PCS	10g	54667	20 PCS	10g
54658	20 PCS	15g	54668	20 PCS	15g
54659	20 PCS	20g	54669	20 PCS	20g
54660	20 PCS	25g	54670	20 PCS	25g
54661	10 PCS	30g	54671	10 PCS	30g
54662	10 PCS	35g	54673	10 PCS	35g
54663	10 PCS	40g	54674	10 PCS	40g

CONTRAPESOS DE CLIP ADESIVAS EM PASTILHAS

52666	70 PCS	60g: 4x10g / 4x5g
-------	--------	-------------------



CONTRAPESO COM GRAPA DE ZINC

JANTE UNIVERSAL

REF.	g						€/kg
54656	5g	100	0.05	-	16	1024	10,50€
54657	10g	100	0.01	-	16	1024	21,00€
54658	15g	100	0.02	-	8	768	31,50€
54659	20g	100	0.02	-	8	640	42,00€
54660	25g	100	0.03	-	8	480	52,50€
54661	30g	100	0.03	-	6	504	63,00€
54662	35g	100	0.04	-	4	320	73,50€
54663	40g	100	0.04	-	4	256	84,00€
54664	45g	100	0.05	-	4	320	94,50€
54665	50g	100	0.05	-	4	256	97,00€

APRESENTAÇÃO EM SACOS DE 100 UNIDADES.

ESPECIAL PARA JANTE ALUMÍNIO

REF.	g						€/kg
54666	5g	100	0.05	-	16	800	10,50€
54667	10g	100	0.01	-	8	768	21,00€
54668	15g	100	0.02	-	12	600	31,50€
54669	20g	100	0.02	-	8	550	42,00€
54670	25g	100	0.03	-	6	480	52,50€
54671	30g	100	0.03	-	6	300	63,00€
54673	35g	100	0.04	-	4	320	73,50€
54674	40g	100	0.04	-	4	320	84,00€
54675	45g	100	0.04	-	4	320	94,50€
54676	50g	100	0.05	-	4	256	97,00€

APRESENTAÇÃO EM SACOS DE 100 UNIDADES.



51355

19,00€

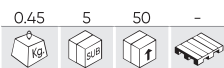

ALICATES DE EQUILÍBRIO DE PESO

Peças	1
Material	CSTL
Comprimento	240mm
Abertura	32mm
Peso	0,45Kg
Dimensões (CxLxA)	320x120x30mm



54013

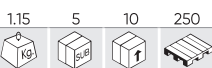

KIT DE REPARAÇÃO DE PNEUS - COMPRESSOR DE LÍQUIDO DE AR

Peças	4
Inclui	15317, 15300, 11960, 53150
Peso	1,15Kg
Dimensões (CxLxA)	210x210x70mm



35,00€



REPOSIÇÕES DISPONÍVEIS

54760



KIT DE REPARAÇÃO DE PNEUS - COMPRESSOR DE LÍQUIDO DE AR

Peças	2
Inclui	17684, 17676
Peso	1,60Kg
Dimensões (CxLxA)	240x165x95mm



38,00€



REPOSIÇÕES DISPONÍVEIS

52652

2,80€

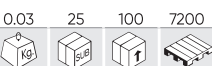

CHAVE MULTIFUNÇÃO PARA OBUSES



52653

3,00€

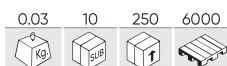

FERRAMENTA PARA OBUSES



51814

8,00€

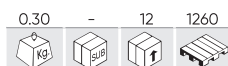

SPRAY TAPA FUROS 300ML



52673

18,00€

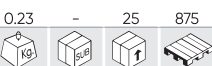

JOGO DE TAPAO E OBUSES PARA PNEUS



REPOSIÇÕES DISPONÍVEIS

Peças	217
Material	Al, PT
Inclui	11903, 11904, 11905, 11906, 11907, 11960
Peso	0,23Kg
Dimensões (CxLxA)	226x115x50mm



53150

24,00€

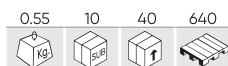

COMPRESSOR DE AR

Tensão de funcionamento	DC12V
Corrente máxima	10A
Potência	100W
Pressão de ar máxima	10BAR
Fluxo de ar	16L/min
Comprimento do cabo	2,8m
Peso	0,55Kg
Dimensões (CxLxA)	55x165x120mm



52662 36,50€

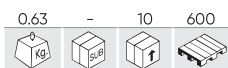

KIT DE REPARAÇÃO DE PNEUS



REPOSIÇÕES DISPONÍVEIS



52663 30,00€

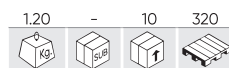

KIT DE REPARAÇÃO DE PNEUS



REPOSIÇÕES DISPONÍVEIS



52643 599,00€



RISCADOR DE PNEUS

Tensão	220V
Potência	350W
Frequência	50-60Hz
Peso	796Kg
Dimensões (CxLxA)	200x130x190mm



REPOSIÇÕES DISPONÍVEIS



VÁLVULAS PARA PNEUS

REF.	DESCRIÇÃO					€
51741	TR413 45mm	0.01	100	1000	48000	0,50€
51742	TR414 51mm	0.01	100	1000	60000	0,50€
51743	TR418 64mm	0.02	100	1000	48000	0,58€



51741



51742



51743

FERRAMENTA PARA INSTALAR VÁLVULAS DE PNEUS

REF.	DESCRIÇÃO					€
52649	METAL	0.32	10	50	2250	5,00€
52650	PLÁSTICO	0.15	10	100	2400	5,00€



52649



52650

FERRAMENTA DESMONTADORA DE PNEUS

REF.					€
52657	0.18	5	20	800	40,50€
52658	0.17	-	20	800	43,00€
52659	0.26	-	20	1920	40,50€
54329	0.20	10	100	-	45,00€



52657



52658



52659



54329

CASQUILHO CENTRADOR PARA RODAS DE PESADOS

REF.	mm						€
52645	25x22x2,5mm	0.01	50	1000	38000		0,55€
52646	25x12x2,0mm	0.00	50	1000	80000		0,50€
53037	23x12x2,5mm	0.01	50	1000	35000		0,50€
53038	21x12x2,5mm	0.01	50	1000	35000		0,50€
53039	25x19x2,5mm	0.02	50	1000	35000		0,50€
53040	25x9x2,5mm	0.01	50	1000	35000		0,50€



AVALANCA PLASTICA DE REMOVER PNEUS

REF.						€
52655	0.39	-	25	1500		40,50€
52656	0.40	5	20	1920		39,50€



ALAVANCA PARA PNEUMÁTICOS

REF.	"						€
51362	12"	0.15	5	60	500		3,00€
51358	16"	0.47	6	24	1008		7,50€
51359	24"	0.90	6	30	1440		9,00€



54136 107,00€



DESMONTADOR DE PNEU MANUAL



Abertura	65mm
Material	S
Peso	5,25Kg
Dimensões (CxLxA)	162x110x257mm

53605 141,00€



DESMONTADOR DE PNEU MANUAL



Faixa	7½"-16"
Material	S
Peso	16,00Kg
Dimensões (CxLxA)	950x210x200mm

52552 128,00€



CALÇADORA DE PNEUS PORTÁTIL



Capacidade	18L
Pressão do trabalho	6-8BAR
Pressão máxima	10BAR
Normas	2014/68/EU, 2014/29/EU
Material	S
Temperatura de trabalho	-20/40°C
Peso	12,00Kg
Dimensões (CxLxA)	430x360x300mm

54582

1.889,00€



EQUILIBRADOR DE RODAS DIGITAL



REPOSIÇÕES
DISPONÍVEIS



VÍDEO
TUTORIAL



Potência	200W
Tensão máxima de entrada	220V/50Hz
RPM (rotações por minuto)	200
Tempo de trabalho	8s
Carga máxima	65Kg
Diâmetro da roda	10-24"
Largura da jante	1,5-20"
Ruído	<70dB
Peso	75,00Kg
Dimensões (CxLxA)	915x760x1180mm

54581

2.389,00€



TROCADOR DE PNEUS SEMIAUTOMÁTICO COM
BRAÇO OSCILANTE



REPOSIÇÕES
DISPONÍVEIS



VÍDEO
TUTORIAL



Alimentação	220V
Potência	0,55-0,75-1,1Kw
Pressão do trabalho	8-10BAR
Torque máx.	1078Nm
Diâmetro máximo da roda	10-22"
Nível de ruído	75dB
Peso	167,00Kg
Dimensões (CxLxA)	960x760x865mm

52660

126,00€

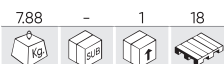

CARRO PORTA PNEUS, CAP. 200KG

Capacidade	200Kg
Abertura	590mm
Material	S
Peso	7,88Kg
Dimensões (CxLxA)	700x400x750mm



52664

168,00€

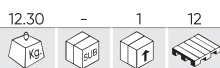

ALAVANCA DE MUDANÇA DE RODAS INDUSTRIAIS

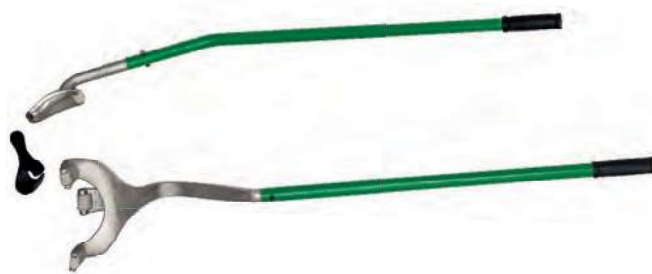

Peças	2
Material	CSTL
Peso	12,30Kg
Dimensões (CxLxA)	740x130x125mm

53542

980,00€



DESTANOLADOR PNEUMATICO DE PNEUS



Consumo real de ar	4CFM (113L/min)
Pressão do trabalho	6,2BAR
Velocidade	10000RPM
Entrada de ar	1/4"
Mangueira	3/8"
Abertura	68mm
Percurso	80mm
Material	S, Al
Peso	4,60Kg
Dimensões (CxLxA)	396x320x160mm

54198

59,00€

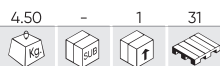

PORTA PNEUS COM RODAS



Capacidade	136Kg
Material	S, PT
Peso	4,50Kg
Dimensões (CxLxA)	660x660x110mm

52842

11,00€

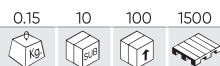

ROLO PARA REPARAÇÃO DA PNEUMÁTICO



Peças	1
Material	S, W
Comprimento	170mm
Diâmetro	38mm
Peso	0,15Kg

53419

10,40€

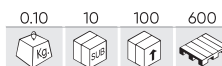

KIT DE 3 PROTETORES DE JANTES



Peças	3
Material	ABS
Comprimento	155mm
Peso	0,10Kg
Dimensões (CxLxA)	155x40x30mm

SEGURANÇA E EPI

LUVAS/EPI	434
DISPENSADORES	438
MEDIDOR DE OZONO	439
DELIMITAÇÃO	440





LUVAS DESCARTÁVEIS 100% NITRILO

LUVAS DESCARTÁVEIS DE NITRILO

5MIL - 5.5G

REF.							€
54151	●	M	100PCS	0.60	10	370	9,00€
54152	●	L	100PCS	0.60	10	370	9,00€
54153	●	XL	100PCS	0.60	10	370	9,00€

3.5MIL - 4.2G

REF.							€
54155	●	M	100PCS	0.46	10	570	8,00€
54156	●	L	100PCS	0.50	10	570	8,00€
54157	●	XL	100PCS	0.55	10	570	8,00€

3.5MIL - 4.2G

REF.							€
54294	●	S	100PCS	0.40	10	500	8,00€
53984	●	M	100PCS	0.45	10	500	8,00€
53985	●	L	100PCS	0.50	10	500	8,00€
53986	●	XL	100PCS	0.55	10	500	8,00€

LUVAS DESCARTÁVEIS DE NITRILO - TEXTURA DIAMANTE

7MIL - 8.4G

REF.							€
54177	●	M	100PCS	0.92	10	300	16,00€
54178	●	L	100PCS	0.96	10	300	16,00€
54179	●	XL	90PCS	0.97	10	300	16,00€

7MIL - 8.4G

REF.							€
54369	●	M	100PCS	0.90	10	300	16,00€
54370	●	L	100PCS	0.88	10	300	16,00€
54371	●	XL	100PCS	1.05	10	300	16,00€

7MIL - 8.4G

REF.							€
53551	●	M	100PCS	0.90	10	300	16,00€
53552	●	L	100PCS	1.00	10	300	16,00€
53553	●	XL	90PCS	1.00	10	300	16,00€



LUVAS COM PALMA REFORÇADA DE POLIURETANO

REF.						€	
51640N	T.8		0.05	12	144	3456	1,54€
51642N	T.9		0.05	12	144	3456	1,54€
51636N	T.10		0.05	12	144	3456	1,54€
51638N	T.11		0.05	12	144	3456	1,54€



LUVAS COM PALMA REFORÇADA DE NITRILO

REF.						€	
51633	T.8		0.04	12	144	3456	1,54€
51634	T.9		0.05	12	144	2592	1,54€
51632N	T.10		0.05	12	144	3456	1,54€
51398N	T.11		0.05	12	144	2592	1,54€



LUVAS TÉRMICAS DE TRABALHO

REF.						€	
54192	T.8		0.15	12	144	3456	9,60€
54193	T.9		0.10	12	144	3456	9,60€
54194	T.10		0.15	12	144	3456	9,60€
54195	T.11		0.10	12	144	3456	9,60€



LUVAS ANTI-CORTE TACTILES

REF.						€	
52570	T.8		0.03	12	144	3456	2,75€
52571	T.9		0.03	12	144	2592	2,75€
52572	T.10		0.03	12	144	2592	2,75€
52573	T.11		0.04	12	144	2592	2,75€



LUVAS DE COURO

REF.						€	
52738	T.9		0.10	12	144	2304	5,00€
52739	T.10		0.12	12	144	2304	5,00€



LUVAS COM PALMA REFORÇADA DE COURO

REF.						€	
52310	T.10		0.20	12	120	1920	3,90€



LUVAS DE ALGODÃO

REF.						€
51745		0.05	12	144	4320	0,70€



LUVAS DE ALGODÃO COM PALMA REFORÇADA DE PONTOS DE BORRACHA

REF.						€
51785		0.04	12	300	3600	1,00€



LUVAS DE TRABALHO

REF.						€
54188	T.8	0.15	12	60	2040	19,00€
54189	T.9	0.15	12	60	720	19,00€
54190	T.10	0.15	12	60	720	19,00€
54191	T.11	0.15	12	60	720	19,00€

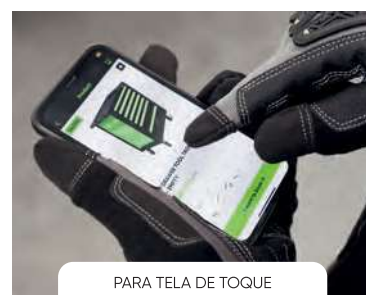

PARA TELA DE TOQUE

ÓCULOS ESPORTIVO DE PROTEÇÃO - ANTI-NEVOEIRO

53596 3,90€

0.01	12	144	2016



EM EXPOSITOR DE 12 UDS

Tipo	Protección solar sport antivaho/Antifog sport protective
Cor	Transparente/Transparent
Normas	EN166:2002-04, EN166:2003-01
Peso	0,01Kg

53597 3,95€

0.01	12	144	2016



EM EXPOSITOR DE 12 UDS

Tipo	Protección solar sport antivaho/Antifog sport protective
Cor	Negro/Black
Normas	EN166:2002-04, EN166:2003-01
Peso	0,01Kg

53598 4,25€

0.01	12	144	2016



EM EXPOSITOR DE 12 UDS

Tipo	Protección solar sport antivaho/Antifog sport protective
Cor	Transparente/Transparent, Negro/Black
Normas	EN166:2002-04, EN166:2003-01
Peso	0,01Kg

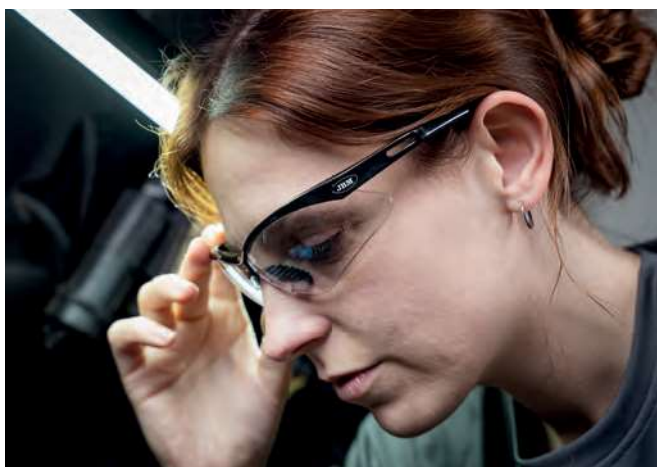

52430

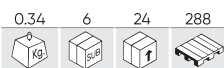

AUSCULTADORES (PASIVO) PARA PROTECÇÃO AUDITIVA

Conformidade com a diretiva europeia	EN352-1:2003
Tipo	Protección auditiva/Hearing protection
Peso	0,34Kg
Dimensões (CxLxA)	216x195mm



12,60€

53785

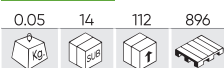

ÓCULOS DE PROTECÇÃO - ANTI-NEVOEIRO

Tipo	Protección antivaho/Antifog safety
Cor	Blanco/White
Normas	EN166:2002-04
Peso	0,05Kg



4,80€

53862

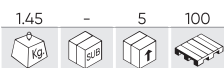

TAPETE COM TANQUE PARA LÍQUIDO DESINFECTANTE



Tipo	Para líquido desinfetante/For disinfectant liquid
Capacidade	8L
Material	TPE
Peso	1,45Kg
Dimensões (CxLxA)	850x540x50mm

53863



TAPETE DE SECAGEM



Tipo	Para secado/For drying
Material	PL
Peso	0,70Kg
Dimensões (CxLxA)	760x460x20mm

3,00€

53794

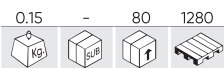

TERMÓMETRO DIGITAL PROFISSIONAL

Unidades de medida	Celsius (°C) / Fahrenheit (°F)
Temperatura de trabalho	16~- 35°C / 60,8~ 95°F
Bateria	2xAAA (DC 3V)
Peso	0,15Kg
Dimensões (CxLxA)	144x101x36mm



2 PILHAS A

28,00€

53902

25,00€

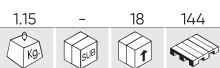

DISPENSADOR AUTOMÁTICO - 1200ML



REPOSIÇÕES DISPONÍVEIS

Material	ABS
Capacidade	1200ml
Peso	1,15Kg
Dimensões (CxLxA)	160x120x295mm

Adequado para sabão líquido, álcool, gel e desinfetante para as mãos

53827

32,00€



SUPORE PARA DISPENSADOR DE GEL AUTOMÁTICO



Material	S
Altura mínima	1580mm
Altura máxima	1250mm
Peso	4,80Kg



14793

12,00€

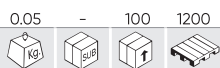

BOMBA DOSEADORA PARA GARRAFO DE 5L



Peso	0,05Kg
Dimensões (CxLxA)	365x38x10mm

53826

16,00€

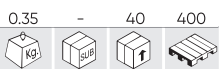

DISTRIBUIDOR AUTOMÁTICO DE GEL - 400ML



Capacidade	400ml
Peso	0,35Kg
Dimensões (CxLxA)	70x116x214mm

53832

1,81€

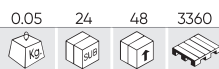

GEL DE MÃOS HIGIENIZANTE 60ML



EM EXPOSITOR DE 24 UDS

Capacidade	60ml
Peso	0,05Kg

53791

4,80€

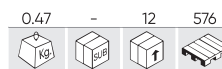

GEL DE MÃOS HIDROALCOÓLICO 500ML



Capacidade	500ml
Peso	0,47Kg

53838

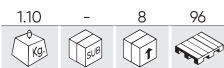

CAIXA DE TRATAMENTO DE OZÔNIO

Potência	2W
Tensão	5V
Produção de ozônio	1,5-2,0mg/h
Corrente de trabalho	0,38-0,42A
Tempo de trabalho	3min
Dimensões dobradas	300x300x50mm
Peso	1,10Kg
Dimensões (CxLxA)	280x280x220mm

38,00€



53796



GERADOR DE OZÔNIO PORTÁTIL 600MG/H (12V/220V)

Potência	15W
Tensão	12V
Fluxo de ar	600mg/h
Intensidade do som	45dB
Volume máximo de desinfecção	500m3
Temporizador	1h, Modo retenção/Hold mode
Sistema de diluição	Ventilador/Fan

76,00€



Material	ME, PT
Peso	0,90Kg
Dimensões (CxLxA)	130x180x80mm

53786

98,00€

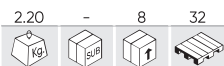

GERADOR DE OZÔNIO PORTÁTIL 5000MG/H (220V)

Potência	60W
Tensão	110-230V
Fluxo de ar	80CFM (2,24m3/min)
Produção de ozônio	5000mg/h
Intensidade do som	45dB
Volume máximo de desinfecção	500m3
Tempo de trabalho necessário para 500m3	120min
Temporizador	2h
Sistema de diluição	Ventilador/Fan
Peso	2,20Kg
Dimensões (CxLxA)	172x187x158mm

53806

250,00€



GERADOR DE OZÔNIO PORTÁTIL 20000MG/H (220V)

Potência	190W
Tensão	220-240V
Fluxo de ar	120CFM (3,40m3/min)
Produção de ozônio	10000-20000mg/h
Intensidade do som	50dB
Volume máximo de desinfecção	500-1000m3
Tempo de trabalho necessário para 500m3	65-80min
Temporizador	2h
Sistema de diluição	Ventilador/Fan
Peso	3,90Kg
Dimensões (CxLxA)	233x300x242mm



REPOSIÇÕES DISPONÍVEIS



REPOSIÇÕES DISPONÍVEIS

53802

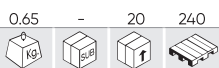

MEDIDOR DE OZÔNIO

Potência	5,55W
Tensão	3,7V
Fluxo de ar	300h
Intensidade do som	85dB
Sistema de diluição	No
Material	ME, ABS
Tempo de trabalho	8h
Tempo de carregamento	4-6h
Tempo de resposta	30s
Temperatura de trabalho	-10-50°C

120,00€



Proteção IP	IP65
Peso	0,65Kg
Dimensões (CxLxA)	60x30x109mm

DISTÂNCIA DE SEGURANÇA - ESPECIAL VDE

REF.	DESCRIÇÃO					€
53940	POSTE DE PLÁSTICO PARA CORRENTE - AMARELO / PRETO	0.55	-	6	90	15,40€
54326	CORRENTE DE PVC - 7M - AMARELO/PRETO	0.30	-	20	600	8,40€
53987	FITA DE SINAL AMARELO/PRETO - 200M	0.59	-	40	560	9,90€
53942	ELO DE FECHAR PRETO	0.01	50	5000	75000	0,50€
54322	CONJUNTO DE 2 SINAIS DE AVISO DE ALTA TENSÃO	0.05	25	100	-	19,00€

DISTÂNCIA DE SEGURANÇA

REF.	DESCRIÇÃO					€
53808	POSTE DE PLÁSTICO PARA CADEIA	0.55	-	6	114	16,50€
53809	CORRENTE DE PVC BRANCA/VERMELHA - 5M	0.30	5	20	960	8,00€
53811	FITA DE SINALIZAÇÃO BRANCA-VERMELHA - 200M	0.45	-	32	576	9,90€
53839	ELO DE FECHAR	0.01	10	2000	16000	0,34€



CONSUMÍVEIS

CHAVETAS E ANÉIS DE RETENÇÃO

442

JUNTAS E ANÉIS DE VEDAÇÃO

451

REBITES

443

CONECTORES DE MANGUEIRAS

452

PARAFUSOS, PORCAS, ARRUELAS

444

ELÉTRICOS

452

ARRUELAS PARA MOTOR E CARTER

446

AGRAFOS E PRESILHAS DE PLÁSTICO

445

OUTROS

449



52044

19,00€

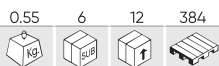

ESTOJO DE CLIPS "R" 150 PEÇAS



REF.					€/UNI
10793	2,3x43	25	20	0,30€	
10794	3,2x52	20	20	0,42€	
10795	3,8x75	8	20	0,68€	
10882	2x32	42	20	0,25€	
10883	1,6x36	30	20	0,25€	
10884	1,6x42	25	20	0,25€	

52027

14,00€

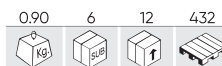

ESTOJO DE CAVILHAS DE FENDAS SORTIDAS 365 PEÇAS



REF.					€/UNI
10796	1,2x25	50	-	0,14€	
10797	1,6x32	50	-	0,14€	
10798	2x40	50	-	0,14€	
10799	2,5x40	50	-	0,14€	
10800	3,2x40	50	-	0,17€	
10801	3,2x50	50	-	0,18€	
10802	4x50	40	-	0,19€	
10803	5x63	10	-	0,20€	
10804	6,3x63	15	-	0,22€	

53348

14,00€

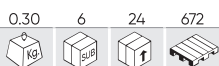

ESTOJO DE CIRCLIPS TIPO "E"



	PCS
M1.5 - 1/16"	15
M3 - 1/8"	15
M5 - 3/16"	20
M6 - 1/4"	25
M9 - 3/8"	25
M12 - 1/2"	20
M15 - 5/8"	10
M19 - 3/4"	10
M22 - 7/8"	10

53350

14,00€



ESTOJO DE PASSADORES ELÁSTICOS



	4		5
1/16" x 3/16"	4	3/16" x 5/8"	5
1/16" x 5/16"	4	3/16" x 1"	5
1/16" x 3/4"	4	3/16" x 1-1/4"	5
5/64" x 1/4"	4	7/32" x 5/8"	4
5/64" x 1/2"	4	7/32" x 1-1/4"	4
5/64" x 1"	4	7/32" x 1-3/4"	4
3/32" x 5/8"	4	1/4" x 5/8"	4
3/32" x 1"	4	1/4" x 1-1/4"	4
3/32" x 1-1/4"	4	1/4" x 1-3/4"	4
1/8" x 5/8"	5	5/16" x 3/4"	4
1/8" x 1"	5	5/16" x 1-1/2"	4
1/8" x 1-1/4"	5	5/16" x 2"	4
5/32" x 5/8"	4	3/8" x 3/4"	2
5/32" x 1"	4	3/8" x 1-1/2"	2
5/32" x 1-1/2"	4	3/8" x 2"	2

53363

34,00€



ESTOJO DE PASSADORES CLEVIS



	PCS
3.5x44	6
2.5x42	20
2.5x58	7
2x3	7

	PCS
8x50	5
9.5x50	18
11x63	5
12.5x50	3

53364

16,00€



ESTOJO DE CHAVETAS



	PCS
3x3x25	4
3x3x20	4
5x5x30	5
5x5x25	5
5x5x20	5
6x6x40	5
6x6x30	5
6x6x20	5
8x8x40	5
8x8x30	5
10x10x40	5
10x10x30	5
12x12x40	2

53371 29,00€

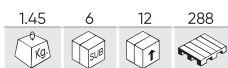

ESTOJO DE PASSADORES COM ANILHA

	PCS
5x36	16
6x45	18
8x45	6
11x45	10



53372 26,50€



ESTOJO DE CHAVETAS

	PCS
M3x50	50
M4x60	30
M5x75	20
M6x50	20
M6x75	16
M8x60	8



53373 15,30€



ESTOJO DE ANILHAS DENTADAS INTERIOR

	PCS
M3x10	30
M4x12	30
M5x14	40
M6x14	50
M8x18	50
M10x20	40
M12x25	20



53383 11,50€



ESTOJO DE ANILHAS SEEGER EXTERIORES

	PCS
M4	50
M6	40
M8	45
M10	30
M12	30
M14	25
M16	25
M18	25
M20	15
M22	15



53382 11,00€



ESTOJO DE ANILHAS SEEGER INTERIORES

	PCS
M4	50
M6	40
M8	45
M10	30
M12	30
M14	25
M16	25
M18	25
M20	15
M22	15

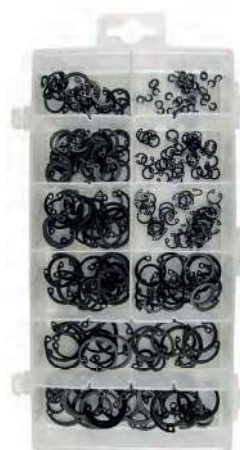

52711 32,00€



ESTOJO DE REBITES PLASTICO

REF.				€/UNI
13674	6x19,3mm	25	25	0,50€
13675	6x17,8mm	25	25	0,50€
13676	6x25,5mm	25	100	0,50€
13677	6x24,5mm	25	25	0,50€
13678	6x24mm	50	25	0,50€



52703

22,00€

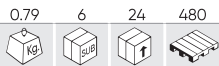

ESTOJO DE REBITES FÊMEA 235 PCS



REF.				€/UNI
13235	M3	50	200	0,15€
13236	M4	50	20	0,15€
13237	M5	50	100	0,15€
13238	M6	40	100	0,22€
13239	M8	20	50	0,30€
13240	M10	15	50	0,40€
13241	M12	10	20	0,55€

53360

18,00€

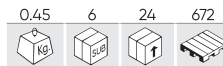

ESTOJO DE REBITES PORCA



	PCS
3x9	40
4x11	35
5x13	25
6x15	25
8x18	15
10x21	10

53361

24,00€

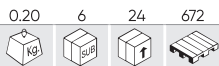

ESTOJO DE REBITES PORCA DE ALUMÍNIO



	PCS
3x9	40
4x11	35
5x13	25
6x15	25
8x18	15
10x21	10

52043

16,50€

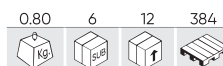

ESTOJO DE REBITES 300 PEÇAS



REF.				€/UNI
10877	4,8x16,90mm	50	10	0,26€
10878	4,8x24,80mm	40	10	0,34€
10879	3,2x9,70mm	90	10	0,20€
10880	4,8x12,70mm	70	10	0,20€
10881	4,80x20mm	50	10	0,26€

53351

12,90€

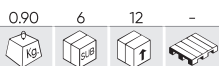

ESTOJO DE PARAFUSOS E PORCAS



	PCS		PCS
M4x12	10	M4	20
M4x20	10	M5	20
M5x16	10	M6	20
M5x25	10	M8	10
M6x20	10	M10	10
M6x30	10		
M8x25	5		PCS
M8x40	5	M4	20
M10x16	5	M5	20
M10x40	5	M6	20
		M8	10
		M10	10

53354

14,00€

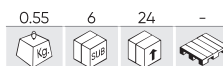

ESTOJO DE PARAFUSOS AUTORROSCANTES



	PCS
#8x12.5	30
#8x16	30
#8x19	30
#8x25	30
#10x12.5	20
#10x16	20
#10x19	20
#10x25	20

53362

14,00€

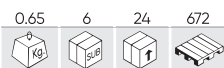

ESTOJO DE PARAFUSOS ALLEN



	PCS
4x12	25
5x12	25
5x25	20
10x40	3
6x25	10
8x40	5
10x25	3
6x12	10
8x25	5



53365

14,70€

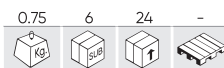

ESTOJO DE PORCAS BOLBOLETA



	PCS
M4	40
M5	40
M6	25
M8	25
M10	20



53366

14,00€

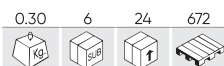

ESTOJO DE PARAFUSOS E PORCAS TIPO U



	PCS
M3.5x8	40
M4.2x16	20
M5x12	15
M6.35x19	10

	PCS
M3.5	20
M3.5 Con muesca/with notch	20
M4	20
M5	15
M6.35	10



53369

14,00€



ESTOJO DE PARAFUSOS



	PCS
2.8x13mm	65
2.8x16mm	55
3.5x10mm	60
3.5x13mm	65
3.5x16mm	60
3.5x19mm	45
4.2x13mm	50
4.2x16mm	40
4.2x25mm	30
4.2x31mm	20
4.8x19mm	25
4.8x25mm	20
4.8x32mm	15



52029

14,00€



ESTOJO DE PORCAS AUTOBLOCANTES 228U.



	PCS
M3	50
M4	50
M5	40
M6	30
M8	20
M10	15
M12	10
M14	8
M16	5



52028

16,50€



ESTOJO DE PORCAS 243 PEÇAS



REF.				€/UNI
10805	M3	50	50	0,05€
10779	M4	50	-	0,05€
10780	M5	50	50	0,05€
10781	M6	30	50	0,05€
10784	M8	20	50	0,05€
10785	M10	20	-	0,19€
10786	M12	10	50	0,19€
10812	M14	8	8	0,30€
10813	M16	5	5	0,30€



52032

30,00€

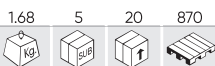

ESTOJO DE ANILHAS DE PRESSÃO PRETAS - 1.735U.



	PCS
3mm	600
4mm	400
5mm	220
6mm	220
8mm	110
10mm	65
12mm	50
14mm	40
16mm	30



53377

22,00€

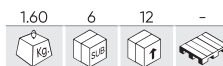

ESTOJO DE ANILHAS DE FERRO SOBRE-MEDIDAS



	PCS
20x6x1.5	20
20x8x1.5	20
20x10x1.5	20
25x6x1.5	20
25x8x1.5	20
25x10x1.5	20
32x2x1.5	20
32x4x1.5	20
32x6x1.5	20
32x8x1.5	20
32x10x1.5	20
32x10x1.5	20



52158

38,50€



ESTOJO DE ANILHAS DE FERRO GALVANIZADO, 475PCS



	PCS		PCS
5x20x1.5	50	6x30x2	25
6x20x1.5	50	7x30x2	25
7x20x1.5	50	8x30x2	25
8x20x1.5	50	4x11x0.98	50
8x25x1.75	50	12x40x3	25
10x30x2.5	25	4x20x1.5	50



51804

63,00€



ESTOJO DE PARAFUSOS, PORCAS E ANILHAS

REPOSIÇÕES DISPONÍVEI

REF.	DESCRIÇÃO			€/UNI
10772	PARAFUSO ZINCADO DIN 933 8.8 M4X25	25	25	0,05€
10773	PARAFUSO ZINCADO DIN 933 8.8 M5X50	25	25	0,10€
10774	PARAFUSO ZINCADO DIN 933 8.8 M6X50	25	25	0,15€
10775	PARAFUSO ZINCADO DIN 933 8.8 M7X50	15	15	0,23€
10776	PARAFUSO ZINCADO DIN 933 8.8 M8X50	15	15	0,33€
10777	PARAFUSO ZINCADO DIN 933 8.8 M10X50	12	12	0,35€
10778	PARAFUSO ZINCADO DIN 933 8.8 M12X60	20	20	0,58€
10779	FÊMEA ZINCADA DIN 934 M4	-	50	0,05€
10780	FÊMEA ZINCADA DIN 934 M5	50	50	0,05€
10781	FÊMEA ZINCADA DIN 934 M6	50	50	0,05€
10782	FÊMEA ZINCADA DIN 934 M7	50	50	0,25€
10783	ANILHA ZINCADA DIN 125 M12	50	50	0,09€
10784	FÊMEA ZINCADA DIN 934 M8	50	50	0,05€
10785	FÊMEA ZINCADA DIN 934 M10	-	50	0,19€
10786	FÊMEA ZINCADA DIN 934 M12	40	50	0,19€
10787	ANILHA ZINCADA DIN 125 M4	50	50	0,05€
10788	ANILHA ZINCADA DIN 125 M5	50	50	0,05€
10789	ANILHA ZINCADA DIN 125 M6	50	50	0,25€
10790	ANILHA ZINCADA DIN 125 M7	50	50	0,25€
10791	ANILHA ZINCADA DIN 125 M8	50	50	0,25€
10792	ANILHA ZINCADA DIN 125 M10	50	50	0,25€

REF.	DESCRIÇÃO			€/UNI
50959	CAIXA 20+1 COMPARTIMENTOS	1	-	14,00€



53464

153,00€



SORTIMENTO DE ANILHAS DE COBRE PARA INJETORES 551 PCS

REPOSIÇÕES DISPONÍVEI

REF.	DESCRIÇÃO			€/△
13945	Ø15.0x8.0x1.5 - UNIVERSAL	30	30	9,20€
13946	Ø15.0x7.0x1.5 - MERCEDES	12	30	8,90€
13947	Ø13.0x7.5x2.5 - RENAULT	30	30	7,70€
13948	Ø15.0x7.5x1.5 - IVECO, FORD, BMW, MAN	30	30	7,80€
13949	Ø15.0x7.5x2.0 - IVECO, FORD, BMW, MAN	30	30	10,00€
13950	Ø15.45x8.0x2.0 - UNIVERSAL	30	30	8,90€
13951	Ø13.5x10x2.0 - MAZDA (REF.. 53464)	12	30	6,30€
13952	Ø15.5x7.5x2.5 - FORD	30	30	12,30€
13953	Ø15.5x7.5x1.5 - LAND ROVER	12	30	8,00€
13954	Ø15.0x7.5x3.0 - RENAULT	30	30	14,30€
13955	Ø13.0x7.0x1.5 - DEUTZ	12	30	5,80€
13956	Ø13.5x7.5x1.5 - FORD	30	30	5,70€
13957	Ø15.0x7.5x1.5 - FIAT	12	30	9,70€
13958	Ø15.5x7.5x1 - MAN ROVER	12	30	6,30€
13959	Ø16.5x7.5x2 - MERCEDES	30	30	10,10€
13960	Ø13.7x7.3x3 - KIA	12	30	11,00€
13961	Ø13.7x7.3x2 - KIA	12	30	10,90€
13962	Ø10x6.0x1.0	50	30	2,20€
13963	Ø15.8x7.5x3.0	30	30	14,00€
13964	SACO DE 30 CONECTORES DE MANGUEIRA EM "T"	20	30	15,70€
13965	Ø8x5.8x1	30	30	1,65€
13966	SACO DE 30 CONECTORES DE MANGUEIRA EM "L"	30	30	15,80€
13967	SACO DE 30 RETENÇÃO SPRINGS	25	30	5,40€



52031

45,50€



SORTIMENTO DE ANILHAS ALUMÍNIO 900 PEÇAS



	PCS
3x7x1.5	50
4x8x1.5	50
5x6x1.5	50
16x22x1.5	50
14x22x1.5	50
14x20x1.5	50
6x10x1.5	50
6x11x1.5	50
7x11x1.5	50
7x12x1.5	50
8x12x1.5	50
8x14x1.5	50
9x12x1.5	50
10x14x1.5	50
11x16x1.5	50
11x17x1.5	50
12x16x1.5	50
12x18x1.5	50



53353

18,00€



SORTIMENTO DE ANILHAS DE COBRE



	PCS
M6	30
M8	25
M10	20
M12	15
M14	10
M16	10



52163

95,00€

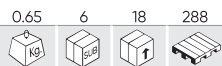

SORTIMENTO DE ANILHAS DE COBRE PARA BUJÕES DE CÁRTER



REPOSIÇÕES DISPONÍVEI

REF.	mm			€/UNI
51538	Ø 10mm	100	100	0,15€
51539	Ø 12mm	100	100	0,18€
51540	Ø 14mm	100	100	0,19€
51541	Ø 16mm	100	100	0,25€
51542	Ø 18mm	100	100	0,25€
51543	Ø 20mm	25	100	0,30€

VOCÊ PODE GOSTAR...

REF.	mm			€/UNI
51544	Ø 22mm	100	100	0,30€
51545	Ø 26mm	100	100	0,36€



52030

98,00€

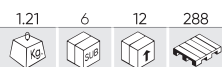

SORTIMENTO DE ANILHAS DE COBRE DE 900 PEÇAS



REPOSIÇÕES DISPONÍVEI

REF.	mm			€/UNI
10823	3x7x1,5mm	50	50	0,20€
10824	4x8x1,5mm	50	-	0,20€
10825	5x6x1,5mm	50	50	0,20€
10826	16x22x1,5mm	50	-	0,43€
10827	14x22x1,5mm	50	-	0,66€
10828	14x20x1,5mm	50	500	0,46€
10829	6x10x1,5mm	50	-	0,20€
10830	6x11x1,5mm	50	100	0,20€
10831	7x11x1,5mm	50	50	0,20€

REF.	mm			€/UNI
10832	7x12x1,5mm	50	-	0,20€
10833	8x12x1,5mm	50	-	0,20€
10834	8x14x1,5mm	50	100	0,26€
10835	9x12x1,5mm	50	-	0,26€
10836	10x14x1,5mm	50	100	0,34€
10837	11x16x1,5mm	50	500	0,34€
10838	11x17x1,5mm	50	-	0,34€
10839	12x16x1,5mm	50	-	0,40€
10840	12x18x1,5mm	50	50	0,65€



ESTOJO DE ANILHAS DE COBRE PARA INJETORES

53229

38,70€

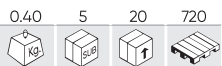

	PCS		PCS
	10		10
13,8x7,3x1,4mm	10	15,0x7,5x3,0mm	10
14,6x7,5x1,3mm	10	15,5x7,5x2,0mm	10
14,6x7,5x3,0mm	10	16,0x7,5x1,5mm	10
15,0x7,0x2,0mm	10	16,0x7,5x1,7mm	10
15,0x7,5x1,0mm	10	16,0x7,5x2,0mm	10
15,0x7,5x1,5mm	10	16,4x7,5x2,0mm	10
15,0x7,5x2,0mm	10	20,0x9,4x0,9mm	10
15,0x7,5x2,5mm	10		



53340

92,00€



	PCS		PCS
	25		25
13,8x7,3x1,4mm	25	15,0x7,5x3,0mm	25
14,6x7,5x1,3mm	25	15,5x7,5x2,0mm	25
14,6x7,5x3,0mm	25	16,0x7,5x1,5mm	25
15,0x7,0x2,0mm	25	16,0x7,5x1,7mm	25
15,0x7,5x1,0mm	25	16,0x7,5x2,0mm	25
15,0x7,5x1,5mm	25	16,4x7,5x2,0mm	25
15,0x7,5x2,0mm	25	20,0x9,4x0,9mm	25
15,0x7,5x2,5mm	25		



53229 - 53340 REPOSIÇÕES DISPONÍVEI

REF.	mm		€/UNI
13819	13,8x7,3x1,4mm	50	11,10€
13820	14,6x7,5x1,3mm	50	11,70€
13821	14,6x7,5x3,0mm	50	24,50€
13822	15,0x7,0x2,0mm	50	19,10€

REF.	mm		€/UNI
13823	15,0x7,5x1,0mm	50	9,60€
13824	15,0x7,5x1,5mm	50	17,40€
13825	15,0x7,5x2,0mm	50	18,10€
13826	15,0x7,5x2,5mm	50	23,00€

REF.	mm		€/UNI
13827	15,0x7,5x3,0mm	50	26,00€
13828	15,5x7,5x2,0mm	50	19,80€
13829	16,0x7,5x1,5mm	50	18,00€
13830	16,0x7,5x1,7mm	50	18,30€

REF.	mm		€/UNI
13831	16,0x7,5x2,0mm	50	22,50€
13832	16,4x7,5x2,0mm	50	23,00€
13833	20,0x9,4x0,9mm	50	15,40€

54390

199,00€

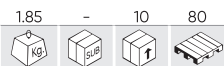

CONJUNTO DE CONECTORES E TUBOS DE COMBUSTÍVEL (95 PÇS)

REPOSIÇÕES DISPONÍVEI

REF.	mm			€/UNI	REF.	mm			€/UNI
16462	6,3x6mm	3	10	47,00€	16538	7,5x200mm	3	3	21,00€
16463	7,89x8mm	3	10	36,50€	16539	12x200mm	1	1	18,00€
16464	9,49x8 mm	3	10	36,50€	16540		1	1	13,00€
16465	9,89x8 mm	3	10	39,50€	16541	6x340mm	2	2	13,00€
16466	11,80x10mm	3	10	50,00€	16542	8x340mm	6	6	23,50€
16467	6,3x6 mm	3	10	36,50€	16543	9,5x340mm	2	2	13,00€
16468	7,89x8 mm	3	10	36,50€					
16469	9,49x8 mm	3	10	36,50€					
16470	9,89x8 mm	3	10	39,50€					
16471	11,8x10mm	3	10	50,00€					
16472	6,3x6 mm	5	10	17,50€					
16473	7,89x8mm	5	10	17,50€					
16474	9,49x8 mm	5	10	17,50€					
16475	9,89x8mm	5	10	17,50€					
16476	11,8x10 mm	5	10	24,00€					
16477	6x7,5mm	3	10	24,50€					
16478	8x7,5mm	6	10	24,50€					
16479	15 - 18mm	12	10	7,60€					
16480	17-20mm	4	10	7,60€					



ANILHAS PARA BUJÃO DE CÁRTER FERRO-BORRACHA

REF.	DESCRIÇÃO					€
52719	ANILHAS PARA BUJAO DE CÁRTER FERRO-BORRACHA 10MM DIAM.	0.01	100	5000	150000	0,19€
51843	ANILHAS PARA BUJAO DE CÁRTER FERRO-BORRACHA 12MM DIÂM.	0.01	100	5000	200000	0,19€
51554	ANILHAS PARA BUJAO DE CÁRTER -BORRACHA (FORD) 13MM DIAM.	0.01	100	5000	180000	0,30€
51546	ANILHAS PARA BUJAO CÁRTER FERRO-BORRACHA 14MM DIAM.	0.01	100	5000	150000	0,19€
51799	ANILHAS PARA BUJAO DE CÁRTER FERRO-BORRACHA 16MM DIAM.	0.01	100	120000	120000	0,20€



53599

31,00€

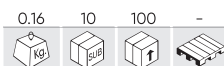

KIT DE VÁLVULAS PARA O AR CONDICIONADO



REPOSIÇÕES DISPONÍVEI

REF.	mm			€/UNI	REF.	mm			€/UNI
14594	5x19mm R12	50	10	3,00€	14599	7x20mm R134A	10	10	6,70€
14595	5x19mm	30	10	2,10€	14600	6x22mm	5	10	15,80€
14596	5x19mm R12	30	10	2,95€	14601	8x22mm	1	10	15,90€
14597	6x19mm	3	10	15,30€	14602	9x22mm	4	10	19,50€
14598	6x26mm	1	10	38,00€					



53358

11,50€

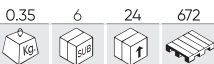

ESTOJO DE MOLAS



SPRINGER	PCS	WWWWW	PCS
5/16x1-3/4	12	13/64x13/16	10
		7/32x1	10
		1/4x7/8	10
9/32x1/2	10	5/16x1-1/8	8
1/4x13/32	10	5/16x1-1/4	10
7/32x11/16	10	3/16x1-3/4	8
7/32x1-1/2	10	9/32x1-1/2	10
3/8x5/8	6	11/32x1-7/16	10
3/8x3/4	12	11/32x1-27/32	12
23/64x1-3/8	8	9/32x2	12
9/32x3/4	10	5/32x3-1/8	12



53352

12,00€

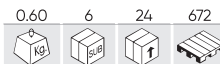

ESTOJO DE PARAFUSOS DE GANCHO



	PCS
2.4x41	50
4x64	12
4.2x85	5
PCS	
2.4x25	60
4x45	12
4x50	12



52033

43,00€

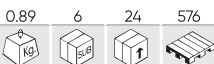

ESTOJO DE BICOS PARA ENGRASSAR - 135 PEÇAS



REF.	90°	€ / 20
10874	6x1	0,42€
10875	8x1	0,66€
10876	10x1	0,74€

REF.	ÂNGULO RECTO	€ / 20
10868	6x1	0,58€
10869	8x1	0,35€
10870	10x1	0,45€

REF.	45°	€ / 20
10871	6x1	0,42€
10872	8x1	0,66€
10873	10x1	0,74€



53359

16,00€

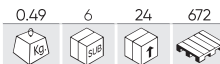

ESTOJO DE LUBRIFICADORES 110 PEÇAS



90°	PCS
6x1	60
8x1.25	10
10x1.5	10
ÂNGULO RECTO	
6x1	5
8x1.25	5
10x1.5	5
45°	
6x1	5
8x1.25	5
10x1.5	5



53378

13,20€

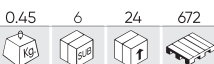

ESTOJO DE ABRAÇADEIRAS DE TUBO 20 PEÇAS



	PCS
1"	4
2-1/2"	2
1-1/4"	2
3"	2
1-3/4"	2
3-1/2"	2
2"	4
4"	2



53381

14,90€

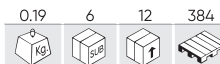

SORTIMENTO DE ANILHAS DE FIBRA 600 PEÇAS



	PCS
10x5.5x1	160
16x10x1	80
19x12x1	40
22x16x1	30
22.5x14x1	20
32x22x1	20
12x6.5x1	100
16x8x1	60
20x12.5x1	40
27x20x1	20
25.4x17.5x1	15
32x24x1	15



50651

18,00€



SORTIMENTO DE O'RINGS MÉTRICAS



	TAPA DEL ESTUCHE						BAZA TRUSEI					
Posição no estôjo	006	007	008	009	010	011	211	212	213	214	215	216
Larg. borracha (mm)	2	2	2	2	2	2	3	3	3	3	3	3
Ø Interior (mm)	A 3	4	5	6	7	8	D 20	22	24	25	27	28
Quantidade	16	16	16	16	16	16	12	12	12	12	12	12
Posição no estôjo	113	112	111	110	012		221	220	219	218	217	
Larg. borracha (mm)	B 2.5	2.5	2.5	2.5	2		E 3	3	3	3	3	
Ø Interior (mm)	14	12	11	10	10		36	35	33	32	30	
Quantidade	13	13	13	13	17		12	12	12	12	12	
Posição no estôjo	114	115	116	210			222	325	326	327		
Larg. borracha (mm)	C 2.5	2.5	2.5	3			F 3	4	4	4		
Ø Interior (mm)	16	17	19	19			38	38	41	44		
Quantidade	13	13	13	10			12	10	9	9		



50652

18,00€



SORTIMENTO DE O'RINGS PULGADAS



	TAPA DEL ESTUCHE						BAZA TRUSEI					
Posição no estôjo	006	007	008	009	010	011	211	212	213	214	215	216
Larg. borracha (mm)	1/16	1/16	1/16	1/16	1/16	1/16	D 1/8	1/8	1/8	1/8	1/8	1/8
Ø Interior (mm)	A 1/8	5/32	3/16	7/32	1/4	5/16	13/16	7/8	15/16	1	11/16	11/18
Quantidade	20	20	20	20	20	20	10	10	10	10	10	10
Posição no estôjo	113	112	111	110	012		221	220	219	218	217	
Larg. borracha (mm)	B 3/32	3/32	3/32	3/32	1/16		E 1/8	1/8	1/8	1/8	1/8	
Ø Interior (mm)	9/16	1/2	7/16	3/8	3/8		17/16	13/8	15/16	11/4	13/16	
Quantidade	13	13	13	13	13		10	10	10	10	10	
Posição no estôjo	114	115	116	210			222	325	326	327		
Larg. borracha (mm)	C 3/32	3/32	3/32	1/8			F 1/8	3/16	3/16	3/16		
Ø Interior (mm)	5/8	11/16	3/4	3/4			11/2	11/2	15/8	13/4		
Quantidade	13	13	13	10			10	7	7	7		
Quantidade												



50807

38,00€



KIT DE O'RINGS PARA AACC



Ø	PCS	Ø	PCS	Ø	PCS
5.29x1.78	20	8.80x1.90	20	13.95x2.62	10
6.07x1.78	20	10.82x1.78	15	14.0x2.0	10
6.8x1.9	20	10.77x2.62	15	15.0x2.0	10
7.65x1.78	20	11.0x2.0	15	17.0x2.0	10
7.80x1.90	20	12.0x2.0	15	17.17x1.78	10
8.0x2.0	20	13.9x1.80	10	17.04x3.53	10



53910

19,00€

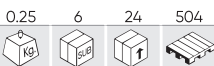

ESTOJO DE CONECTORES DE MANGUEIRA
113 PEÇAS



RETO		TUBO EM T	
4.8x4.8	10	3.9x3.9x3.9	8
6.3x6.3	8	4.8x4.8x4.8	8
7.9x7.9	6	6.3x6.3x6.3	6
9.5x9.5	6	9.5x9.5x9.5	3
3.17x3.17	30	3.17x3.17x3.17	12
REDUTOR			
9.5x6.3	6		
6.3x4.8	10		



53434

18,00€

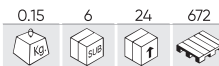

ESTOJO DE CONECTORES DE MANGUEIRA
65 PEÇAS



PCS	
4x28.7	10
3.9x30.8	5
10.4x44	10
5.6x47.1	5
7.9x38	10
4.7x38.9	5
5.2x33.9	10
7x30	10



53992

18,00€

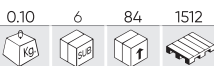

ESTOJO DE MANGAS DE SOLDA
TERMOENCOLHÍVEIS 100PCS



Ø1.7mm / 0.25-0.34mm ² / 26-24 AWG	25
Ø2.7mm / 0.5-1.0mm ² / 22-18 AWG	35
Ø4.7mm / 1.5-2.5mm ² / 16-14 AWG	30
Ø6.0mm / 4.0-6.0mm ² / 12-10 AWG	10



53349

14,00€

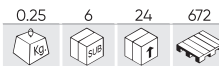

ESTOJO DE PASSA-CABOS DE BORRACHA



ABERTOS		FECHADOS	
	PCS		PCS
M19,5x23	2	M25	2
M16x24	3	M22	3
M13x15	3	M19	4
M11,5x19	4	M15	5
M10x20	3	M12	10
M10x12	5	M9	20
M9,8x11,5	6	M7	20
M8x14	3		
M7,5x13	7		
M6x7,5	10		
M3,5x6	15		



53374

10,00€

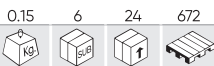

ESTOJO DE TUBOS TERMO-RETRACTÍLES



	PCS
M2x40	30
M2.5x40	25
M3.5x40	20
M5x40	20
M7x80	16
M10x80	8
M13x85	8



53376

10,50€

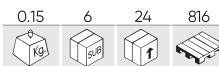

ESTOJO DE TUBOS TERMO-RETRACTÍLES
VERMELHOS



	PCS
M2x40	30
M2.5x40	25
M3.5x40	20
M5x40	20
M7x80	16
M10x80	8
M13x85	8



REF. 51920 MAÇARICO

0.14 10 100 400 € 18,00€

53370

26,00€

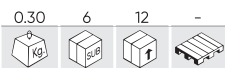

ESTOJO DE PASSA-CABOS DE BORRACHA - M2,3,4,5,6,8,10



PCS

M2	25
M3	25
M4	30
M5	30
M6	30
M8	20
M10	20

53355

11,50€

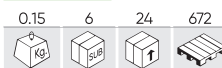

ESTOJO DE FUSÍVEIS MINI



PCS

5A	20
10A	20
15A	20
20A	20
25A	20
30A	20

53356

11,50€



ESTOJO DE FUSÍVEIS



REF.	5A	10A	15A	20A	25A	30A	€ / UNI
10915	20	20	20	20	20	20	0,25€
10917	20	20	20	20	20	20	0,30€

REF.	5A	10A	15A	20A	25A	30A	€ / UNI
10918	20	20	20	20	20	20	0,30€

REF.	5A	10A	15A	20A	25A	30A	€ / UNI
10919	20	20	20	20	20	20	0,30€
10920	20	20	20	20	20	20	0,25€
10921	20	20	20	20	20	20	0,30€

53367

9,50€



ESTOJO DE FUSÍVEIS DE 48 U



PCS

5A	8
10A	8
15A	8



PCS

20A	8
25A	8
30A	8

53368

9,00€

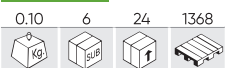

ESTOJO DE FUSÍVEIS DE 50 U.



PCS

5A	8
10A	8
15A	8
20A	8
25A	8
30A	10

53380

12,40€



ESTOJO DE FUSÍVEIS



PCS

5A	20
10A	20
15A	20
20A	20
25A	20
30A	20

52054

17,00€



ESTOJO DE FUSÍVEIS 252 PEÇAS



REF.	Imagem	Quantidade	€ / UNI
10905	3A	20	0,28€
10906	4A	20	0,28€
10907	5A	20	0,34€

REF.	Imagem	Quantidade	€ / UNI
10908	7,5A	20	0,34€
10909	10A	20	0,34€
10910	15A	20	0,34€

REF.	Imagem	Quantidade	€ / UNI
10911	20A	20	0,34€
10912	25A	20	0,26€
10913	30A	20	0,34€

REF.	Imagem	Quantidade	€ / UNI
10914	4A	8	0,27€
10915	5A	8	0,25€
12954	3A	8	0,30€

REF.	Imagem	Quantidade	€ / UNI
10916	7,5A	8	0,34€
10917	10A	8	0,30€
10918	15A	8	0,30€

REF.	Imagem	Quantidade	€ / UNI
10919	20A	8	0,30€
10920	25A	8	0,25€
10921	30A	8	0,30€



52053

45,00€



ESTOJO DE TERMINAIS 635 PEÇAS



REF.	Imagem	Quantidade	€ / UNI
10885	RV1.25-4S	50	0,20€
10886	RV2-4S	50	0,20€
10887	RV2-6S	30	0,26€
10888	RV5.5-6S	20	0,34€
10889	RV5.5-5S	20	0,34€
10893	RV2-5S	40	0,26€

REF.	Imagem	Quantidade	€ / UNI
10894	SV1-4S	50	0,20€
10895	SV2-4S	40	0,20€

REF.	Imagem	Quantidade	€ / UNI
10896	FDD1.25-250	45	0,34€
10898	FDD2-250	40	0,34€
10900	FDD5.5-250	25	0,30€

REF.	Imagem	Quantidade	€ / UNI
10890	BV5.5	15	0,41€
10891	BV2	25	0,34€
10892	BV1.25	30	0,34€

REF.	Imagem	Quantidade	€ / UNI
10897	MDD1.25-250	50	0,30€
10899	MDD2-250	50	0,34€
10901	MDD5.5-250	30	0,26€

REF.	Imagem	Quantidade	€ / UNI
10902	FDN 1.25-250	25	0,31€



ALICATE PARA TERMINAIS

PÁGINA 64



53357

7,00€

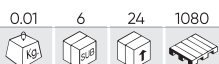

KIT DE 2 PINÇAS DE CROCODILO



Peças	2
Amperes	30AMP
Comprimento	100mm
Peso	0,01Kg

53385

19,30€



ALICATE PARA EXTRAÇÃO DE GRAMPOS DE CARROCERIA



Peças	1
Material	CrV
Comprimento	170mm
Abertura	27mm
Peso	0,15Kg



16294 14,00€

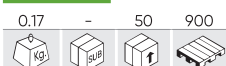

PÔSTER DE CLIPS TAMANHO REAL

Peças	1
Material	Papel plastificado/Laminated paper
Peso	0,17Kg
Dimensões (CxX)	1000x640mm



TAMANHO REAL DE LOS CLIPS
CLIPS REAL SIZE

52851 9,65€

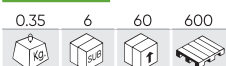

JOGO DE 2 ALAVANCAS PARA EXTRAÇÃO DE GRAMPOS



Peças	2
Peso	0,35Kg
Dimensões (CxLxA)	310x103x30mm

53110 29,50€



KIT DE 6 ALAVANCAS



Peças	6
Peso	1,42Kg
Dimensões (CxLxA)	600x250x40mm



UNIDADES NO CASO



UNIDADES POR SACO DE PEÇAS SOBRESSALENTES



APRESENTAÇÃO EM UM EXPOSITOR

52896

27,50€



SORTIMENTO DE CLIPS PARA MAZDA 190PCS

REF.	DESCRIÇÃO			€/kg
13104	OE:2042301	8	8	3,70€
13105	OE:999100402	15	15	5,60€
13106	OE:B0016830200	8	8	4,40€
13107	OE:N30413356A	8	8	4,40€
13108	OE:992640543A	20	20	4,10€
13109	OE:99249051B	30	30	6,30€
13110	OE:6508197AA	15	15	3,90€
13111	OE:B1016825200	10	10	2,45€
13112	OE:B09251833	6	6	2,75€
13113	OE:992640543A	20	20	4,80€
13114	OE:B45556741	20	20	4,75€
13115	OE:G03158762	30	30	5,30€



INFORMAÇÕES TÉCNICAS

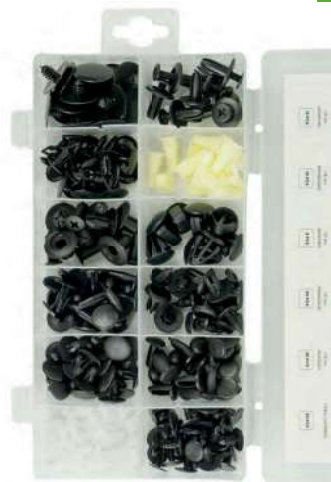

52886

18,00€



SORTIMENTO DE CLIPS PARA LEXUS / TOYOTA 89 PCS

REF.	DESCRIÇÃO			€/kg
13002	OE:9018906001	8	8	2,65€
13003	OE:9046707138	5	4	3,70€
13004	OE:9046707117	10	10	3,40€
13005	OE:9046709138	10	10	2,60€
13006	OE:9046709101	5	5	2,75€
13007	OE:75521611000	10	10	2,75€
13008	OE:7503933060	8	8	5,00€
13009	OE:9017905060	4	4	3,70€
13010	OE:677711250	8	8	3,05€
13011	OE:9046708124	5	5	2,55€
13012	OE:7539533030	8	8	4,00€
13013	OE:9046711063	8	8	3,90€



INFORMAÇÕES TÉCNICAS



52887

22,00€



SORTIMENTO DE CLIPS PARA HONDA 150 PCS

REF.	DESCRIÇÃO			€/kg
13014	OE:75103SJ4003	12	12	3,15€
13015	OE:90675SB003	5	5	2,45€
13016	OE:91566SP0003	6	6	2,45€
13017	OE:91513SE003	25	25	5,60€
13018	OE:91530ST5003	25	25	2,90€
13019	OE:90687SA50030	15	15	3,70€
13020	OE:91620SR2003	8	8	3,80€
13021	OE:38529689A6300	8	8	2,85€
13022	OE:90683SA5003	10	10	4,00€
13023	OE:90672671003	10	10	3,25€
13024	OE:91534SEO000	18	18	5,40€
13025	OE:34355SD2003	8	8	3,35€



INFORMAÇÕES TÉCNICAS





52899

34,00€

0.50 6 24 336



SORTIMENTO DE CLIPS PARA PEUGOT / CITROEN 345 PCS

REF.	DESCRIÇÃO			€/∆
13128	OE:947098	50	50	3,70€
13129	OE:856535	20	20	4,40€
13130	OE:6991W4	20	20	7,90€
13131	-	20	20	5,40€
13132	OE:694143	25	25	5,30€
13133	OE:743707	35	35	7,70€
13134	OE:7703074022	30	30	8,90€
13135	OE:7703077059	35	35	7,70€
13136	OE:698317	15	15	5,50€
13137	OE:699502	25	25	4,95€
13138	OE:6995X3	30	30	5,50€
13139	OE:69945	40	40	8,50€



INFORMAÇÕES TÉCNICAS



52900

34,50€

0.50 6 24 336



SORTIMENTO DE CLIPS PARA FIAT 308 PCS

REF.	DESCRIÇÃO			€/∆
13140	OE:14591784	30	30	5,70€
13141	OE:1459487	20	10	3,90€
13142	OE:1300433650	25	25	6,50€
13143	OE:71717421	8	8	4,50€
13144	OE:82456515	25	25	4,75€
13145	OE:5757139	25	25	8,50€
13146	-	20	8	9,90€
13147	OE:46306526	25	25	6,90€
13148	OE:14591687	25	25	7,00€
13149	OE:14592387	25	25	6,10€
13150	OE:83468473	30	30	4,80€
13151	OE:7677865	50	30	11,90€



INFORMAÇÕES TÉCNICAS



52901

35,00€

0.48 6 24 216



SORTIMENTO DE CLIPS PARA VOLVO 350 PCS

REF.	DESCRIÇÃO			€/∆
13152	OE:8099905N07	25	25	6,90€
13153	OE:4292906	30	30	6,60€
13154	OE:12681763	20	20	7,20€
13155	OE:51131804205	40	40	12,60€
13156	OE:947098	40	40	7,20€
13157	OE:591740	40	40	8,50€
13158	OE:6384801G00	25	25	7,90€
13159	OE:9133417	20	20	6,20€
13160	OE:9133073	40	40	11,20€
13161	OE:3272075327462B	30	30	7,90€
13162	OE:327462A	20	20	5,90€
13163	OE:3923712	20	20	6,30€



INFORMAÇÕES TÉCNICAS



52889

19,00€

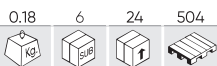

SORTIMENTO DE CLIPS PARA VOLKSWAGEN 85 PCS

REF.	DESCRIÇÃO			€/kg
13038	OE:1H0868243B	2	2	2,85€
13039	OE:N90833801	10	10	2,95€
13040	OE:3A0853575	8	8	3,90€
13041	OE:4A0853825	5	5	3,50€
13042	OE:6U085733	15	15	4,05€
13043	OE:3B0853576	3	3	2,65€
13044	OE:1H0819055B01C	6	6	3,40€
13045	OE:443853909A	5	5	2,60€
13046	OE:171885767	6	6	3,40€
13047	OE:N9020160H	5	5	2,75€
13048	OE:N0385501	10	10	3,70€
13049	OE:191941142	10	10	4,45€



INFORMAÇÕES TÉCNICAS



52891

28,00€

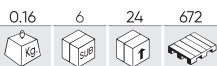

SORTIMENTO DE CLIPS PARA FORD 169 PCS

REF.	DESCRIÇÃO			€/kg
13056	OE:388577S	8	8	3,20€
13057	OE:N801925S	5	5	3,30€
13058	OE:N806289S	20	20	4,75€
13059	OE:N379830S	20	20	5,20€
13060	OE:1007932	5	5	2,65€
13061	OE:16500308	20	20	5,50€
13062	OE:N803170S	20	20	5,20€
13063	OE:W706713S300	6	6	2,45€
13064	OE:N388246S	20	20	5,70€
13065	OE:F22216774A	15	15	4,30€
13066	OE:1673046	5	5	4,00€
13067	OE:FICZ16674A	25	25	5,60€



INFORMAÇÕES TÉCNICAS



52894

22,00€

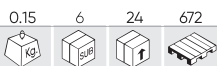

SORTIMENTO DE CLIPS PARA NISSAN 139 PCS

REF.	DESCRIÇÃO			€/kg
13080	OE:76906T300	15	15	3,70€
13081	OE:0155300172	20	20	5,10€
13082	OE:68425H5000	10	10	2,95€
13083	OE:75521611000	6	6	2,95€
13084	OE:62869N4700	20	20	4,40€
13085	OE:6384401A00	5	5	2,95€
13086	OE:7688257A00	5	5	2,85€
13087	OE:6684101G00	25	25	7,30€
13088	OE:1099830880	10	10	5,10€
13089	OE:8942798070	10	10	3,20€
13090	OE:6384801G00	8	8	3,80€
13091	OE:6385401A00	5	5	2,75€



INFORMAÇÕES TÉCNICAS



52890

22,00€



SORTIMENTO DE CLIPS PARA AUDI 31 PCS

REF.	DESCRIÇÃO			€/1
13050	OE:3B0868243	5	15	3,90€
13051	OE:1H0867199A	5	20	2,75€
13052	OE:1H0868243B	3	3	2,65€
13053	OE:357853575	10	10	5,70€
13054	OE:1H0853585A	5	5	5,20€
13055	OE:3A0853575	3	3	6,80€



INFORMAÇÕES TÉCNICAS



52892

22,00€



SORTIMENTO DE CLIPS PARA BMW 95 PCS

REF.	DESCRIÇÃO			€/1
13068	OE:51311802258	25	25	6,00€
13069	OE:5131804205	30	30	9,90€
13070	OE:51118174185	10	10	3,50€
13071	OE:51481938725	10	10	3,80€
13072	OE:703867299	15	15	4,85€
13073	OE:51131960054	5	5	4,75€



INFORMAÇÕES TÉCNICAS



52897

38,00€



SORTIMENTO DE CLIPS PARA RENAULT 300 PCS

REF.	DESCRIÇÃO			€/1
13116	OE:7703077421	50	50	11,90€
13117	-	50	50	7,70€
13118	OE:7703081184	60	60	36,50€
13119	-	15	15	12,90€
13120	OE:7703074022	60	60	11,90€
13121	OE:7703077059	65	65	19,30€



INFORMAÇÕES TÉCNICAS



52898

36,00€



SORTIMENTO DE CLIPS PARA VAUXHALL / OPEL 300 PCS

REF.	DESCRIÇÃO			€/1
13122	OE:90218614	20	20	4,30€
13123	OE:174864	40	40	10,50€
13124	OE:NO385501	100	100	18,30€
13125	OE:2345959	50	50	11,00€
13126	OE:2240582	50	50	5,30€
13127	OE:180942	40	40	12,60€



INFORMAÇÕES TÉCNICAS



52893

26,00€



SORTIMENTO DE CLIPS PARA BENZ 95 PCS

REF.	DESCRIÇÃO			€/kg
13074	OE:A0019884481	30	30	9,80€
13075	OE:A0019882981	20	20	11,90€
13076	OE:A1249900492	15	15	7,20€
13077	OE:A0019888081	4	4	5,80€
13078	OE:A1249880492	6	6	5,80€
13079	OE:A0019880325	20	20	7,20€



INFORMAÇÕES TÉCNICAS



52895

22,00€

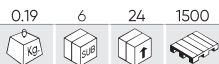

SORTIMENTO DE CLIPS PARA MITSUBISHI 134 PCS

REF.	DESCRIÇÃO			€/kg
13092	OE:8942180270	15	50	3,55€
13093	OE:9018905013	30	30	6,30€
13094	OE:MU480033	10	10	3,25€
13095	OE:128100231	8	6	2,75€
13096	OE:MU480034	8	8	3,80€
13097	OE:MR138807	3	3	2,65€
13098	OE:MB253964	4	4	3,50€
13099	OE:HB121467	30	30	5,80€
13100	OE:MB271999	3	3	2,75€
13101	OE:MB696120	8	8	3,20€
13102	OE:MR200300	5	5	2,65€
13103	OE:MB846992	10	10	3,90€



INFORMAÇÕES TÉCNICAS



52888

24,00€

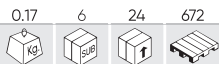

SORTIMENTO DE CLIP UNIVERSAL 128 PCS

REF.	DESCRIÇÃO			€/kg
13026	OE:388577S	8	8	2,65€
13027	-	10	10	4,00€
13028	OE:6003423	6	6	2,85€
13029	OE:VW:N989022 CHRYSLER: 6003349 FORD:385661	6	6	3,50€
13030	OE:CHRYSLER: 6502328 GM:20699808	25	25	5,90€
13031	OE:N804379S	4	4	3,80€
13032	OE:FORD:F22216774A MAZDA:6508197AA	15	15	4,35€
13033	OE:GM:16674629 FORD:N806113S	10	10	3,60€
13034	OE:0153301781	20	20	5,80€
13035	OE:GM:10124502 BMW:52201964201 LAND ROVER:DZM10080	6	6	3,05€
13036	OE:VW:N9020160H BMW:51471904317 OPEL:2207713	6	6	2,65€
13037	-	12	12	4,30€



INFORMAÇÕES TÉCNICAS



53720

19,00€

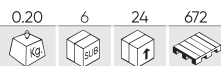

SORTIMENTO DE 112 PÇS DE CLIPES PARA TAPEÇARIA DE BMW MINI

REF.	DESCRIÇÃO			€/△
14447	OE: 51471911992	7	6	2,75€
14449	OE: 51717002953	13	10	4,85€
14471	OE: 51489119216	5	5	4,35€
14472	OE: A0009905492	5	5	3,00€
14474	OE: 51118174185	8	8	3,40€
14475	OE: 2019900050	6	6	3,70€
14476	OE: 51481915964	9	9	4,65€
14477	OE: 0009881625	15	15	5,70€
14478	OE: 7146976114	15	15	9,40€
14479	OE: 91503SP0003	6	6	3,70€
14480	-	15	15	4,65€
14481	OE: 51161943122	8	8	3,60€



53719

19,00€

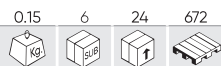

SORTIMENTO DE CLIPES PARA PAINÓS DE PORTA / MOLDURAS

REF.	DESCRIÇÃO			€/△
14359	-	8	8	2,05€
14458	-	6	6	3,80€
14459	OE: 7147122912	2	2	3,20€
14460	OE: 51411973500	8	8	2,45€
14461	-	8	8	3,00€
14462	-	8	8	3,70€
14463	OE: 611769	10	10	3,70€
14464	OE: 7147145753	10	10	3,40€
14465	-	8	8	4,55€
14466	OE: 51418224768	8	4	3,70€
14468	-	8	8	2,85€
14469	OE: 7147133419	8	8	3,30€



53718

19,00€



SORTIMENTO DE 151 PÇS DE CLIPES PARA TAPEÇARIA DE MERCEDES-BENZ

REF.	DESCRIÇÃO			€/△
14422	OE: A0009913940	20	20	3,40€
14446	OE: 9903492	6	6	6,40€
14447	OE: 51471911992	12	12	2,75€
14448	OE: N105835019B9	10	10	4,65€
14449	OE: A0009905492	12	12	4,85€
14450	OE: N0385012	12	12	4,85€
14451	OE: A1239900092	25	25	4,85€
14452	-	20	20	5,90€
14453	-	6	6	7,00€
14455	-	12	12	4,85€
14456	-	6	6	3,00€
14457	OE: A1249900492	10	10	3,80€



53717

19,00€

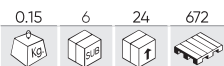

SORTIMENTO DE 96 PÇS DE CLIPES PARA PAINÉIS DE PORTA/MOLDURAS DE MERCEDES-BENZ

REF.	DESCRIÇÃO			€/box
14434	-	8	8	3,40€
14435	-	6	6	3,30€
14436	OE: A0009910198	8	8	3,80€
14437	OE: A0019912698	6	6	3,30€
14438	OE: A0089880978	8	8	3,00€
14439	OE: 0069884378	8	8	3,90€
14440	-	8	8	3,90€
14441	OE: 0019884981	10	10	3,70€
14442	-	6	6	3,30€
14443	-	8	8	3,20€
14444	OE: 0019886081	10	10	4,35€
14445	-	10	10	3,20€



INFORMAÇÕES TÉCNICAS



53716

19,00€



SORTIMENTO DE 79 PÇS DE CLIPES PARA PAINÉIS DE PORTA/MOLDURAS/TAPEÇARIA DE VAG/SEAT/SKODA

REF.	DESCRIÇÃO			€/box
14422	OE: A0009913940	6	6	3,40€
14423	OE: 6E0837732	15	15	8,30€
14424	-	7	7	4,20€
14425	OE: 6Q0868243	2	2	4,10€
14426	OE: 171201969	8	8	4,35€
14427	OE: 4D0807300	8	4	2,65€
14428	OE: 251823717	12	12	3,10€
14429	-	6	6	4,10€
14430	OE: 8E0821989A	3	3	5,20€
14431	OE: 3B0868243	2	2	3,20€
14432	OE: 1H0823171	10	10	3,20€



INFORMAÇÕES TÉCNICAS



53715

19,00€

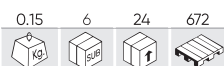

SORTIMENTO DE 110 PÇS DE CLIPES PARA TAPEÇARIA DE PEUGEOT/CITROËN

REF.	DESCRIÇÃO			€/box
14410	-	10	10	3,80€
14411	-	10	5	3,80€
14412	-	10	10	3,80€
14413	-	10	10	7,60€
14414	OE: 2346824	10	10	3,80€
14415	OE: A1249900492	10	10	3,70€
14416	OE: 6992C6	10	5	2,45€
14419	-	15	15	4,45€
14420	-	15	15	3,40€
14421	OE: 14093311	10	10	5,70€



INFORMAÇÕES TÉCNICAS



53714

16,00€

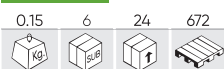

SORTIMENTO DE 80 PÇS DE CLIPES PARA MOLDURAS DE PEUGEOT/CITROËN

REF.	DESCRIÇÃO			€/kg
14398	OE: 6995X3	8	8	2,85€
14399	OE: 129943	12	6	4,35€
14402	OE: 856548	8	8	3,00€
14404	OE: 71728806	8	8	4,35€
14405	OE: 968865987703	16	8	3,20€
14406	OE: 856540	10	10	3,50€
14408	OE: 856534	10	10	3,20€
14409	OE: 357853586	8	8	3,00€



INFORMAÇÕES TÉCNICAS



53713

16,00€



SORTIMENTO DE 93 PÇS DE CLIPES PARA PAINÉIS DE PORTA DE PEUGEOT/H16CITROËN

REF.	DESCRIÇÃO			€/kg
14350	OE: 6991Y8	6	6	3,70€
14358	OE: PG 6991Y8 CT 6991Y8 FIAT 9654280780 RENAULT 703077469	10	10	4,10€
14387	-	8	8	3,20€
14388	OE: 7703077250	8	8	4,65€
14389	OE: 6995A3	6	6	2,75€
14390	-	6	6	3,00€
14391	-	15	15	4,95€
14392	-	6	6	3,00€
14393	-	8	8	3,40€
14395	-	8	8	3,70€
14396	-	6	6	2,55€
14397	-	6	6	3,00€



INFORMAÇÕES TÉCNICAS



53712

16,00€

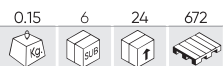

SORTIMENTO DE 109 PÇS DE CLIPES DE ESTOFADO PARA TAPEÇARIA DE RENAULT DACIA

REF.	DESCRIÇÃO			€/kg
14374	OE: 7703077435	3	3	3,30€
14375	-	15	15	4,20€
14376	OE: 7L6868307	20	20	6,00€
14377	-	10	10	4,35€
14378	OE: 7703077117	12	12	4,35€
14379	-	6	6	3,30€
14381	-	10	10	3,80€
14382	OE: 7703077153	6	6	4,20€
14383	OE: 7703072360	10	10	2,35€
14384	OE: W705956S300	12	12	4,55€
14416	OE: 6992C6	5	5	2,45€



INFORMAÇÕES TÉCNICAS



53711



SORTIMENTO DE 90 PÇS DE CLIPES PARA MOLDURAS+H13 DE RENAULT DACIA

REF.	DESCRIÇÃO	10	10	€/△
14356	OE: RENAULT 7703077368 OPEL 4430858	10	10	4,35€
14358	OE: PG 6991Y8 CT 6991Y8 FIAT 9654280780 RENAULT 703077469	12	10	4,10€
14364	OE: OP 7701470779 NI 7703077421 RENAULT 7703077421 IV 500326896	10	10	4,35€
14365	OE: OP 7701470779 NI 7703077421 RENAULT 7703077421 IV 500326896	10	10	4,35€
14366	OE: PG 6991Y8 CT 6991Y8 FIAT 9654280780 RENAULT 703077469	8	8	3,20€
14367	-	3	3	2,85€
14368	OE: 7L5853994	8	8	3,20€
14369	OE: 7701061797	15	15	11,60€
14370	-	3	3	6,90€
14371	-	3	3	6,90€
14372	-	4	4	2,65€
14373	-	4	4	3,00€



INFORMAÇÕES TÉCNICAS

53710

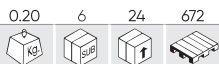

SORTIMENTO DE 85 PÇS DE CLIPES PARA PAINÉIS DE PORTA DE RENAULT DACIA

REF.	DESCRIÇÃO	12	6	€/△
14350	OE: 6991Y8	12	6	3,70€
14351	-	8	15	3,70€
14352	OE: 51447780135	7	7	2,85€
14353	OE: 7703077476	8	2	4,75€
14355	OE: 7703077354	8	8	3,80€
14356	OE: RENAULT 703077368 OPEL 4430858	10	4	4,35€
14357	OE: 7703077430	10	12	4,35€
14358	OE: PG 6991Y8 CT 6991Y8 FIAT 9654280780 RENAULT 703077469	10	6	4,10€
14359	OE: 51418224768	4	3	2,05€
14361	-	8	15	3,80€



INFORMAÇÕES TÉCNICAS

